

SMALL-OUTLINE DDR SDRAM DIMM

MT16VDDF6464H – 512MB MT16VDDF12864H – 1GB

For the latest data sheet, please refer to the Micron® Web site: www.micron.com/modules

Features

- 200-pin, small-outline, dual in-line memory module (SODIMM)
- Fast data transfer rates: PC1600, PC2100, and PC2700
- Utilizes 200 MT/s, 266 MT/s, or 333 MT/s DDR SDRAM components
- 512MB (64 Meg x 64), 1GB (128 Meg x 64)
- VDD = VDDQ = +2.5V
- VDDSPD = +2.3V to +3.6V
- 2.5V I/O (SSTL_2 compatible)
- Commands entered on each positive CK edge
- DQS edge-aligned with data for READS; center-aligned with data for WRITES
- Internal, pipelined double data rate (DDR) architecture; two data accesses per clock cycle
- Bidirectional data strobe (DQS) transmitted/received with data—i.e., source-synchronous data capture
- Differential clock inputs CK and CK#
- Four internal device banks for concurrent operation
- Programmable burst lengths: 2, 4, or 8
- Auto precharge option
- Auto Refresh and Self Refresh Modes
- 7.8125µs maximum average periodic refresh interval
- Serial Presence Detect (SPD) with EEPROM
- Programmable READ CAS latency
- Gold edge contacts

Figure 1: 200-Pin SODIMM (MO-224)

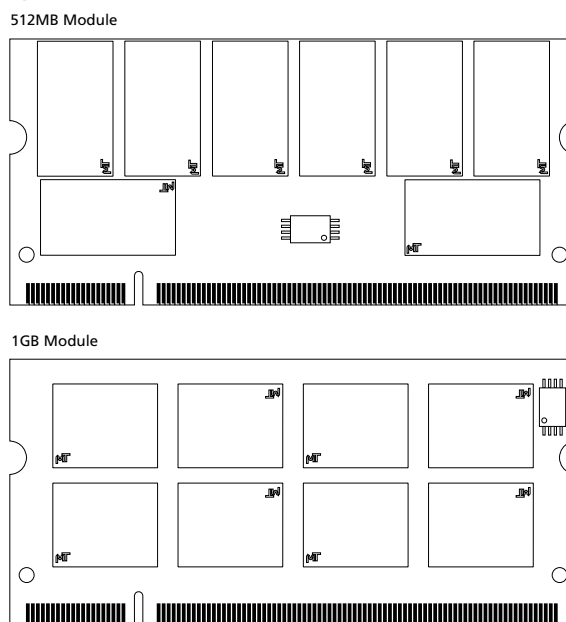

OPTIONS

- Package
 - 200-pin SODIMM (standard) G
 - 200-pin SODIMM (lead-free)¹ Y
- Frequency/CAS Latency²
 - 167 MHz (333 MT/s) CL = 2.5 -335
 - 133 MHz (266 MT/s) CL = 2 -262
 - 133 MHz (266 MT/s) CL = 2 -26A
 - 133 MHz (266 MT/s) CL = 2.5 -265
 - 100 MHz (200 MT/s) CL = 2 -202

MARKING

NOTE: 1. Contact factory for availability of lead-free products.
2. CL = CAS (READ) latency.

Table 1: Address Table

	512MB	1GB
Refresh Count	8K	8K
Device Row Addressing	8K (A0–A12)	8K (A0–A12)
Device Bank Addressing	4 (BA0, BA1)	4 (BA0, BA1)
Device Configuration	32 Meg x 8	64 Meg x 8
Device Column Addressing	1K (A0–A9)	2K (A0–A9, A11)
Module Rank Addressing	2 (S0#, S1#)	2 (S0#, S1#)



Table 2: Part Numbers and Timing Parameters

PART NUMBER	MODULE DENSITY	CONFIGURATION	TRANSFER RATE	MEMORY CLOCK/ DATA BIT RATE	LATENCY (CL - t _{RCD} - t _{RP})
MT16VDDF6464HG-335__	512MB	64 Meg x 64	2.7 GB/s	6ns/333 MT/s	2.5-3-3
MT16VDDF6464HY-335__	512MB	64 Meg x 64	2.7 GB/s	6ns/333 MT/s	2.5-3-3
MT16VDDF6464HG-262__	512MB	64 Meg x 64	2.1 GB/s	7.5ns/266 MT/s	2-2-2
MT16VDDF6464HY-262__	512MB	64 Meg x 64	2.1 GB/s	7.5ns/266 MT/s	2-2-2
MT16VDDF6464HG-26A__	512MB	64 Meg x 64	2.1 GB/s	7.5ns/266 MT/s	2-3-3
MT16VDDF6464HY-26A__	512MB	64 Meg x 64	2.1 GB/s	7.5ns/266 MT/s	2-3-3
MT16VDDF6464HG-265__	512MB	64 Meg x 64	2.1 GB/s	7.5ns/266 MT/s	2.5-3-3
MT16VDDF6464HY-265__	512MB	64 Meg x 64	2.1 GB/s	7.5ns/266 MT/s	2.5-3-3
MT16VDDF6464HG-202__	512MB	64 Meg x 64	1.6 GB/s	10ns/200 MT/s	2-2-2
MT16VDDF6464HY-202__	512MB	64 Meg x 64	1.6 GB/s	10ns/200 MT/s	2-2-2
MT16VDDF12864HG-335__	1GB	128 Meg x 64	2.7 GB/s	6ns/333 MT/s	2.5-3-3
MT16VDDF12864HY-335__	1GB	128 Meg x 64	2.7 GB/s	6ns/333 MT/s	2.5-3-3
MT16VDDF12864HG-262__	1GB	128 Meg x 64	2.1 GB/s	7.5ns/266 MT/s	2-2-2
MT16VDDF12864HY-262__	1GB	128 Meg x 64	2.1 GB/s	7.5ns/266 MT/s	2-2-2
MT16VDDF12864HG-26A__	1GB	128 Meg x 64	2.1 GB/s	7.5ns/266 MT/s	2-3-3
MT16VDDF12864HY-26A__	1GB	128 Meg x 64	2.1 GB/s	7.5ns/266 MT/s	2-3-3
MT16VDDF12864HG-265__	1GB	128 Meg x 64	2.1 GB/s	7.5ns/266 MT/s	2.5-3-3
MT16VDDF12864HY-265__	1GB	128 Meg x 64	2.1 GB/s	7.5ns/266 MT/s	2.5-3-3
MT16VDDF12864HG-202__	1GB	128 Meg x 64	1.6 GB/s	10ns/200 MT/s	2-2-2
MT16VDDF12864HY-202__	1GB	128 Meg x 64	1.6 GB/s	10ns/200 MT/s	2-2-2

NOTE:

All part numbers end with a two-place code (not shown), designating component and PCB revisions. Consult factory for current Revision codes. Example: MT16VDDF6464HG-265A1.

**Table 3: Pin Assignment
(200-Pin SODIMM Front)**

PIN	SYMBOL	PIN	SYMBOL	PIN	SYMBOL	PIN	SYMBOL
1	VREF	51	Vss	101	A9	151	DQ42
3	Vss	53	DQ19	103	Vss	153	DQ43
5	DQ0	55	DQ24	105	A7	155	VDD
7	DQ1	57	VDD	107	A5	157	VDD
9	VDD	59	DQ25	109	A3	159	Vss
11	DQS0	61	DQS3	111	A1	161	Vss
13	DQ2	63	Vss	113	VDD	163	DQ48
15	Vss	65	DQ26	115	A10	165	DQ49
17	DQ3	67	DQ27	117	BA0	167	VDD
19	DQ8	69	VDD	119	WE#	169	DQS6
21	VDD	71	DNU	121	S0#	171	DQ50
23	DQ9	73	DNU	123	NC	173	Vss
25	DQS1	75	Vss	125	Vss	175	DQ51
27	Vss	77	DNU	127	DQ32	177	DQ56
29	DQ10	79	DNU	129	DQ33	179	VDD
31	DQ11	81	VDD	131	VDD	181	DQ57
33	VDD	83	DNU	133	DQS4	183	DQS7
35	CK0	85	NC	135	DQ34	185	Vss
37	CK0#	87	Vss	137	Vss	187	DQ58
39	Vss	89	DNU	139	DQ35	189	DQ59
41	DQ16	91	DNU	141	DQ40	191	VDD
43	DQ17	93	VDD	143	VDD	193	SDA
45	VDD	95	CKE1	145	DQ41	195	SCL
47	DQS2	97	NC	147	DQS5	197	VDDSPD
49	DQ18	99	A12	149	Vss	199	NC

**Table 4: Pin Assignment
(200-Pin SODIMM Back)**

PIN	SYMBOL	PIN	SYMBOL	PIN	SYMBOL	PIN	SYMBOL
2	VREF	52	Vss	102	A8	152	DQ46
4	Vss	54	DQ23	104	Vss	154	DQ47
6	DQ4	56	DQ28	106	A6	156	VDD
8	DQ5	58	VDD	108	A4	158	CK1#
10	VDD	60	DQ29	110	A2	160	CK1
12	DM0	62	DM3	112	A0	162	Vss
14	DQ6	64	Vss	114	VDD	164	DQ52
16	Vss	66	DQ30	116	BA1	166	DQ53
18	DQ7	68	DQ31	118	RAS#	168	VDD
20	DQ12	70	VDD	120	CAS#	170	DM6
22	VDD	72	DNU	122	S1#	172	DQ54
24	DQ13	74	DNU	124	NC	174	Vss
26	DM1	76	Vss	126	Vss	176	DQ55
28	Vss	78	DNU	128	DQ36	178	DQ60
30	DQ14	80	DNU	130	DQ37	180	VDD
32	DQ15	82	VDD	132	VDD	182	DQ61
34	VDD	84	DNU	134	DM4	184	DM7
36	VDD	86	DNU	136	DQ38	186	Vss
38	Vss	88	Vss	138	Vss	188	DQ62
40	Vss	90	Vss	140	DQ39	190	DQ63
42	DQ20	92	VDD	142	DQ44	192	VDD
44	DQ21	94	VDD	144	VDD	194	SA0
46	VDD	96	CKE0	146	DQ45	196	SA1
48	DM2	98	NC	148	DM5	198	SA2
50	DQ22	100	A11	150	Vss	200	Vss

Figure 2: Module Layout

Table 5: Pin Descriptions

Pin numbers may not correlate with symbols. Refer to Pin Assignment Tables on page 3 for more information

PIN NUMBERS	SYMBOL	TYPE	DESCRIPTION
118, 119, 120	WE#, CAS#,RAS#	Input	Command Inputs: RAS#, CAS#, and WE# (along with S#) define the command being entered.
35, 37, 158, 160	CK0, CK0# CK1, CK1#	Input	Clock: CK, CK# are differential clock inputs. All address and control input signals are sampled on the crossing of the positive edge of CK, and negative edge of CK#. Output data (DQs and DQS) is referenced to the crossings of CK and CK#.
95, 96	CKE0, CKE1	Input	Clock Enable: CKE HIGH activates and CKE LOW deactivates the internal clock, input buffers and output drivers. Taking CKE LOW provides PRECHARGE POWER-DOWN and SELF REFRESH operations (all device banks idle), or ACTIVE POWER-DOWN (row ACTIVE in any device bank). CKE is synchronous for POWER-DOWN entry and exit, and for SELF REFRESH entry. CKE is asynchronous for SELF REFRESH exit and for disabling the outputs. CKE must be maintained HIGH throughout read and write accesses. Input buffers (excluding CK, CK# and CKE) are disabled during POWER-DOWN. Input buffers (excluding CKE) are disabled during SELF REFRESH. CKE is an SSTL_2 input but will detect an LVCMOS LOW level after VDD is applied and until CKE is first brought HIGH. After CKE is brought HIGH, it becomes an SSTL_2 input only.
121, 122	S0#, S1#	Input	Chip Selects: S# enables (registered LOW) and disables (registered HIGH) the command decoder. All commands are masked when S# is registered HIGH. S# is considered part of the command code.
116, 117	BA0, BA1	Input	Bank Address: BA0 and BA1 define to which device bank an ACTIVE, READ, WRITE, or PRECHARGE command is being applied.
99, 100, 101, 102, 105,106, 107, 108, 109, 110, 111, 112, 115	A0-A12	Input	Address Inputs: Provide the row address for ACTIVE commands, and the column address and auto precharge bit (A10) for READ/WRITE commands, to select one location out of the memory array in the respective device bank. A10 sampled during a PRECHARGE command determines whether the PRECHARGE applies to one device bank (A10 LOW, device bank selected by BA0, BA1) or all device banks (A10 HIGH). The address inputs also provide the op-code during a MODE REGISTER SET command. BA0 and BA1 define which mode register (mode register or extended mode register) is loaded during the LOAD MODE REGISTER command.
1, 2	VREF	Input	SSTL_2 reference voltage.
195	SCL	Input	Serial Clock for Presence-Detect: SCL is used to synchronize the presence-detect data transfer to and from the module.
194, 196, 198	SA0-SA2	Input	Presence-Detect Address Inputs: These pins are used to configure the presence-detect device.
193	SDA	Input/ Output	Serial Presence-Detect Data: SDA is a bidirectional pin used to transfer addresses and data into and out of the presence-detect portion of the module.
12, 26, 48, 62, 134, 148, 170, 184	DM0-DM7	Input	Data Write Mask. DM LOW allows WRITE operation. DM HIGH blocks WRITE operation. DM lines do not affect READ operation.

Table 5: Pin Descriptions (Continued)

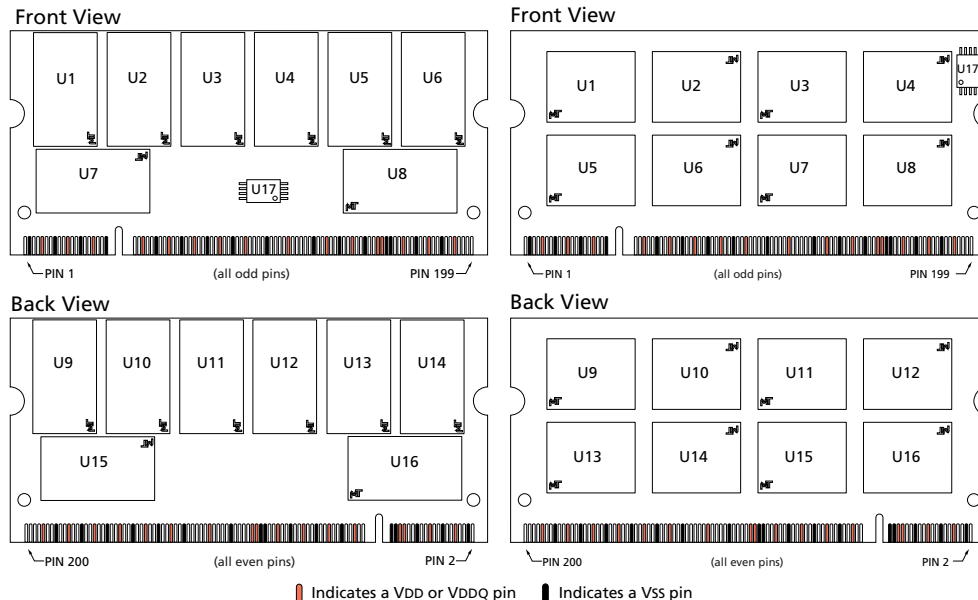
Pin numbers may not correlate with symbols. Refer to Pin Assignment Tables on page 3 for more information

PIN NUMBERS	SYMBOL	TYPE	DESCRIPTION
11, 25, 47, 61, 133, 147, 169, 183	DQS0-DQS7	Input/Output	Data Strobe: Output with READ data, input with WRITE data. DQS is edge-aligned with READ data, centered in WRITE data. Used to capture data.
5, 6, 7, 8, 13, 14, 17, 18, 19, 20, 23, 24, 29, 30, 31, 32, 41, 42, 43, 44, 49, 50, 53, 54, 55, 56, 59, 60, 65, 66, 67, 68, 127, 128, 129, 130, 135, 136, 139, 140, 141, 142, 145, 146, 151, 152, 153, 154, 163, 164, 165, 166, 171, 172, 175, 176, 177, 178, 181, 182, 187, 188, 189, 190	DQ0-DQ63	Input/Output	Data I/Os: Data bus.
9, 10, 21, 22, 33, 34, 36, 45, 46, 57, 58, 69, 70, 81, 82, 92, 93, 94, 113, 114, 131, 132, 143, 144, 155, 156, 157, 167, 168, 179, 180, 191, 192	VDD	Supply	Power Supply: +2.5V ±0.2V.
3, 4, 15, 16, 27, 28, 38, 39, 40, 51, 52, 63, 64, 75, 76, 87, 88, 90, 103, 104, 125, 126, 137, 138, 149, 150, 159, 161, 162, 173, 174, 185, 186, 200	VSS	Supply	Ground.
197	VDDSPD	Supply	Serial EEPROM positive power supply: +2.3V to +3.6V
85, 97, 98, 123, 124, 199	NC	—	No Connect: These pins should be left unconnected.
71, 72, 73, 74, 77, 78, 79, 80, 83, 84, 86, 89, 91	DNU	—	Do Not Use: These pins are not connected on this module, but are assigned pins on other modules in this product family.

Figure 3: Functional Block Diagram – 512MB

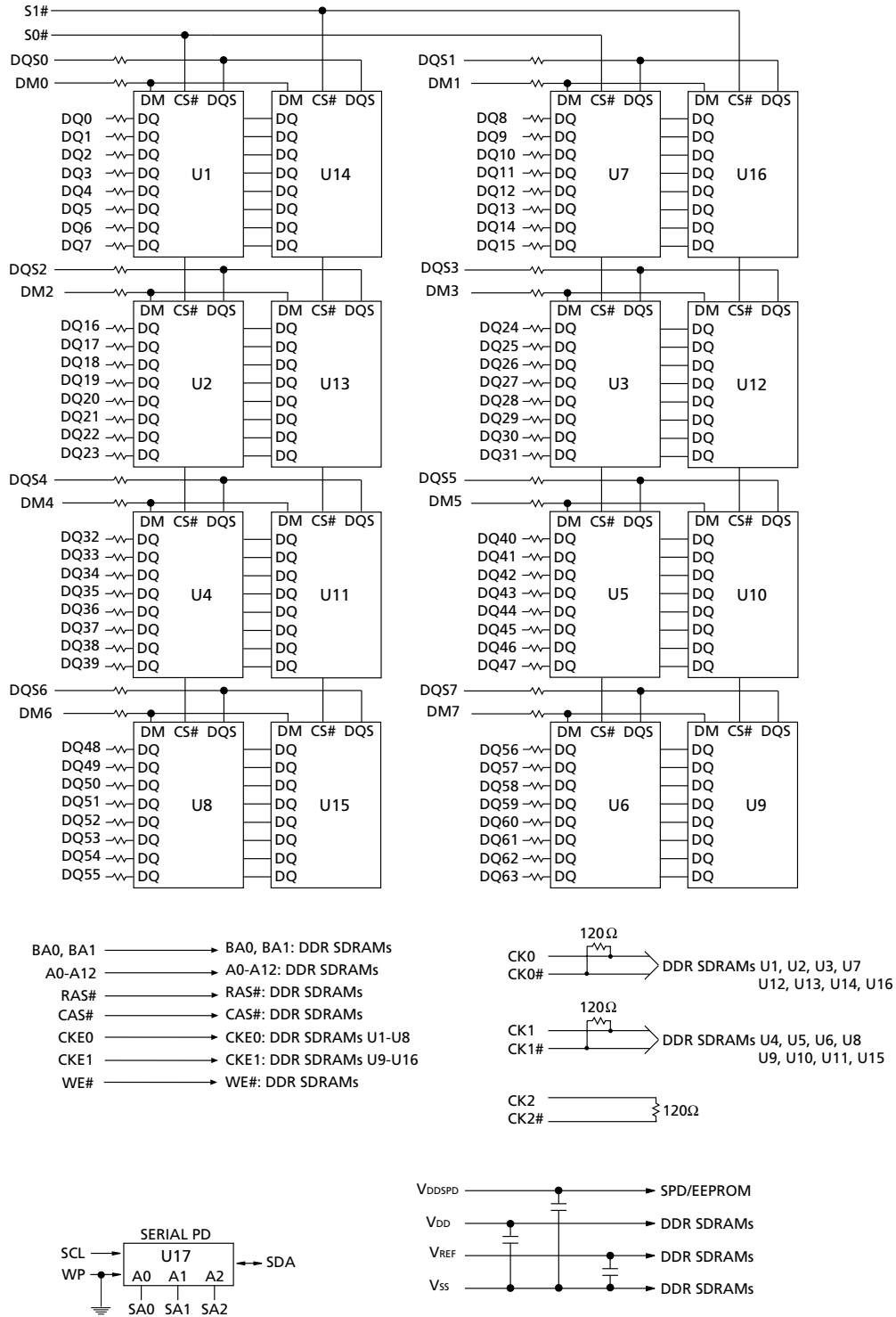

NOTE:

1. All resistor values are 22Ω unless otherwise specified.
2. Per industry standard, Micron utilizes various component speed grades as referenced in the Module Part Numbering Guide at www.micron.com/numberguide.

DDR SDRAMs: MT46V32M8S2FD
 DDR SDRAMs: MT46V64M8S2FD

Figure 4: Functional Block Diagram – 1GB

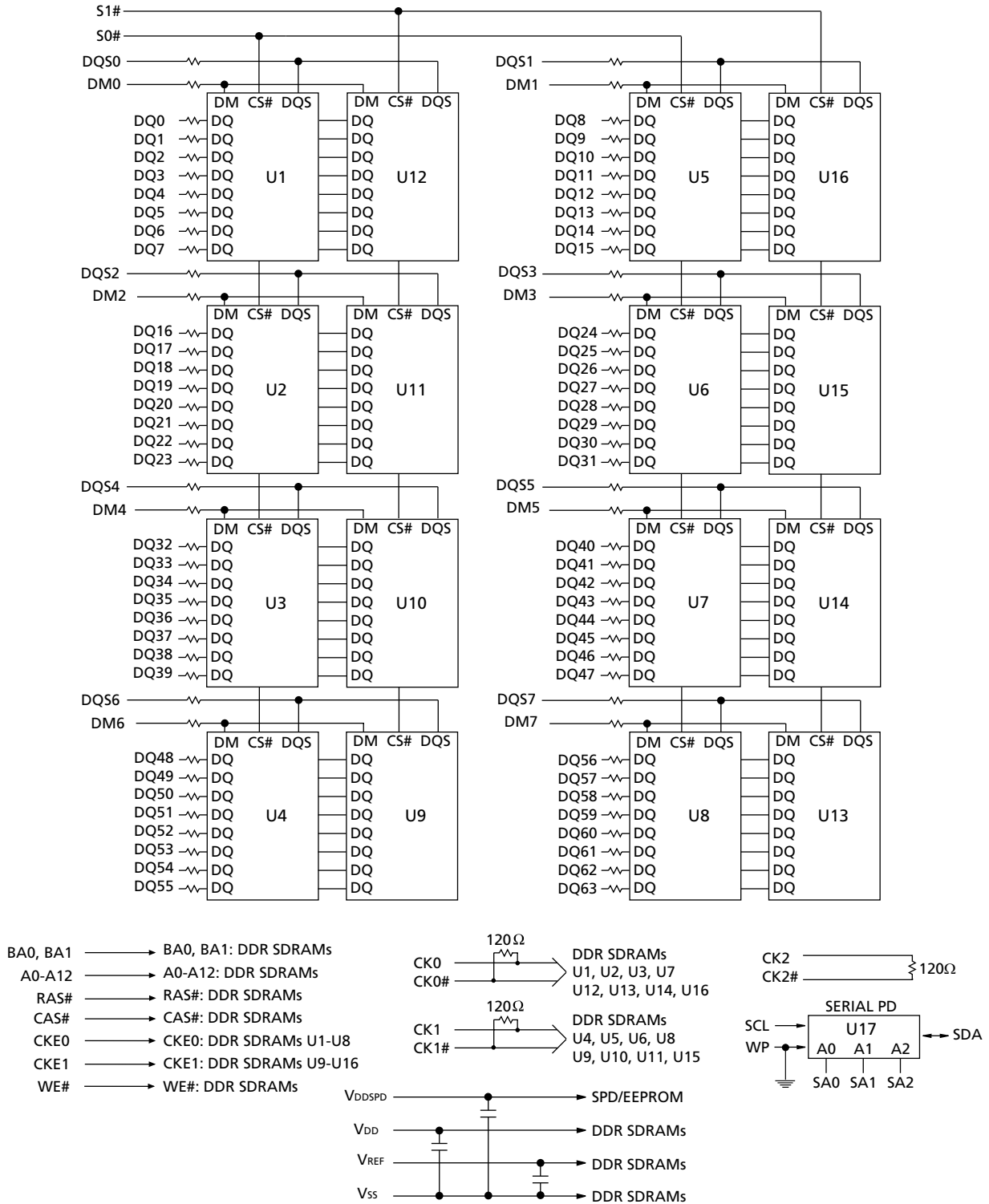

NOTE:

- All resistor values are 22Ω unless otherwise specified.
- Per industry standard, Micron utilizes various component speed grades as referenced in the Module Part Numbering Guide at www.micron.com/numberguide.

DDR SDRAMs: MT46V32M8S2FD
DDR SDRAMs: MT46V64M8S2FD

General Description

The MT16VDDF6464H and MT16VDDF12864H are high-speed CMOS, dynamic random-access, 512MB and 1GB memory modules organized in a x64 configuration. These modules use internally configured quad-bank DRAM devices.

DDR SDRAM modules use a double data rate architecture to achieve high-speed operation. The double data rate architecture is essentially a $2n$ -prefetch architecture with an interface designed to transfer two data words per clock cycle at the I/O pins. A single read or write access for the DDR SDRAM module effectively consists of a single $2n$ -bit wide, one-clock-cycle data transfer at the internal DRAM core and two corresponding n -bit wide, one-half-clock-cycle data transfers at the I/O pins.

A bidirectional data strobe (DQS) is transmitted externally, along with data, for use in data capture at the receiver. DQS is an intermittent strobe transmitted by the DDR SDRAM during READs and by the memory controller during WRITEs. DQS is edge-aligned with data for READs and center-aligned with data for WRITEs.

DDR SDRAM modules operate from a differential clock (CK and CK#); the crossing of CK going HIGH and CK# going LOW will be referred to as the positive edge of CK. Commands (address and control signals) are registered at every positive edge of CK. Input data is registered on both edges of DQS, and output data is referenced to both edges of DQS, as well as to both edges of CK.

Read and write accesses to DDR SDRAM modules are burst oriented; accesses start at a selected location and continue for a programmed number of locations in a programmed sequence. Accesses begin with the registration of an ACTIVE command, which is then followed by a READ or WRITE command. The address bits registered coincident with the ACTIVE command are used to select the device bank and row to be accessed (BA0, BA1 select devices bank; A0–A12 select device row). The address bits registered coincident with the READ or WRITE command are used to select the device bank and the starting device column location for the burst access.

DDR SDRAM modules provides for programmable read or write burst lengths of 2, 4, or 8 locations. An auto precharge function may be enabled to provide a self-timed row precharge that is initiated at the end of the burst access.

As with standard SDR SDRAM modules, the pipelined, multibank architecture of DDR SDRAM modules allows for concurrent operation, thereby providing

high effective bandwidth by hiding row precharge and activation time.

An auto refresh mode is provided, along with a power-saving power-down mode. All inputs are compatible with the JEDEC Standard for SSTL_2. All outputs are SSTL_2, Class II compatible. For more information regarding DDR SDRAM operation, refer to the 256Mb or 512Mb DDR SDRAM data sheets.

Serial Presence-Detect Operation

DDR SDRAM modules incorporate serial presence-detect (SPD). The SPD function is implemented using a 2,048-bit EEPROM. This nonvolatile storage device contains 256 bytes. The first 128 bytes can be programmed by Micron to identify the module type and various SDRAM organizations and timing parameters. The remaining 128 bytes of storage are available for use by the customer. System READ/WRITE operations between the master (system logic) and the slave EEPROM device (DIMM) occur via a standard I²C bus using the DIMM's SCL (clock) and SDA (data) signals, together with SA (2:0), which provide eight unique DIMM/EEPROM addresses. Write protect (WP) is tied to ground on the module, permanently disabling hardware write protect.

Mode Register Definition

The mode register is used to define the specific mode of operation of the DDR SDRAM. This definition includes the selection of a burst length, a burst type, a CAS latency and an operating mode, as shown in Figure 5, Mode Register Definition Diagram, on page 9. The mode register is programmed via the MODE REGISTER SET command (with BA0 = 0 and BA1 = 0) and will retain the stored information until it is programmed again or the device loses power (except for bit A8, which is self-clearing).

Reprogramming the mode register will not alter the contents of the memory, provided it is performed correctly. The mode register must be loaded (reloaded) when all device banks are idle and no bursts are in progress, and the controller must wait the specified time before initiating the subsequent operation. Violating either of these requirements will result in unspecified operation.

Mode register bits A0–A2 specify the burst length, A3 specifies the type of burst (sequential or interleaved), A4–A6 specify the CAS latency, and A7–A12 specify the operating mode.

Burst Length

Read and write accesses to the DDR SDRAM are burst oriented, with the burst length being programmable, as shown in Figure 5, Mode Register Definition Diagram. The burst length determines the maximum number of column locations that can be accessed for a given READ or WRITE command. Burst lengths of 2, 4, or 8 locations are available for both the sequential and the interleaved burst types.

Reserved states should not be used, as unknown operation or incompatibility with future versions may result.

When a READ or WRITE command is issued, a block of columns equal to the burst length is effectively selected. All accesses for that burst take place within this block, meaning that the burst will wrap within the block if a boundary is reached. The block is uniquely selected by A1–Ai when the burst length is set to two, by A2–Ai when the burst length is set to four and by A3–Ai when the burst length is set to eight (where Ai is the most significant column address bit for a given configuration. See Note 5 of Table 6, Burst Definition Table, on page 10, for Ai values). The remaining (least significant) address bit(s) is (are) used to select the starting location within the block. The programmed burst length applies to both read and write bursts.

Burst Type

Accesses within a given burst may be programmed to be either sequential or interleaved; this is referred to as the burst type and is selected via bit M3.

The ordering of accesses within a burst is determined by the burst length, the burst type and the starting column address, as shown in Table 6, Burst Definition Table, on page 10.

Read Latency

The READ latency is the delay, in clock cycles, between the registration of a READ command and the availability of the first bit of output data. The latency can be set to 2 or 2.5 clocks, as shown in Figure 6, CAS Latency Diagram, on page 10.

If a READ command is registered at clock edge *n*, and the latency is *m* clocks, the data will be available nominally coincident with clock edge *n + m*. The CAS Latency Table indicates the operating frequencies at which each CAS latency setting can be used.

Reserved states should not be used as unknown operation or incompatibility with future versions may result.

Figure 5: Mode Register Definition Diagram

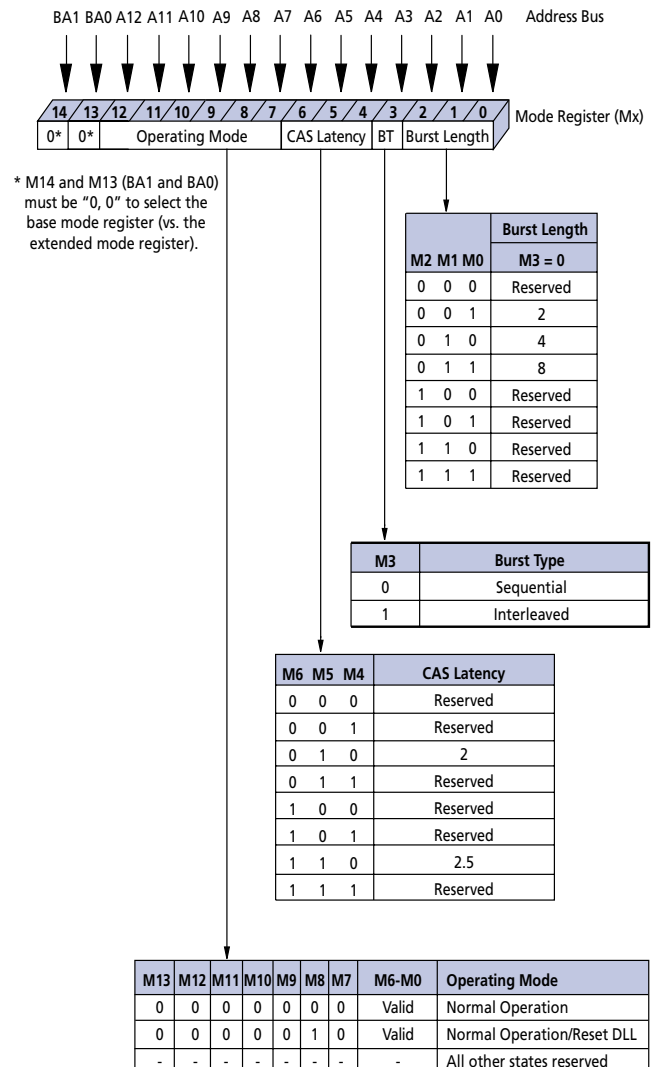

Table 6: Burst Definition Table

BURST LENGTH	STARTING COLUMN ADDRESS		ORDER OF ACCESSES WITHIN A BURST		
			TYPE = SEQUENTIAL	TYPE = INTERLEAVED	
2	A0				
	0		0-1	0-1	
	1		1-0	1-0	
4	A1	A0			
	0	0	0-1-2-3	0-1-2-3	
	0	1	1-2-3-0	1-0-3-2	
	1	0	2-3-0-1	2-3-0-1	
	1	1	3-0-1-2	3-2-1-0	
8	A2	A1	A0		
	0	0	0	0-1-2-3-4-5-6-7	0-1-2-3-4-5-6-7
	0	0	1	1-2-3-4-5-6-7-0	1-0-3-2-5-4-7-6
	0	1	0	2-3-4-5-6-7-0-1	2-3-0-1-6-7-4-5
	0	1	1	3-4-5-6-7-0-1-2	3-2-1-0-7-6-5-4
	1	0	0	4-5-6-7-0-1-2-3	4-5-6-7-0-1-2-3
	1	0	1	5-6-7-0-1-2-3-4	5-4-7-6-1-0-3-2
	1	1	0	6-7-0-1-2-3-4-5	6-7-4-5-2-3-0-1
	1	1	1	7-0-1-2-3-4-5-6	7-6-5-4-3-2-1-0

NOTE:

- For a burst length of two, A1-A_i select the two-data-element block; A0 selects the first access within the block.
- For a burst length of four, A2-A_i select the four-data-element block; A0-A1 select the first access within the block.
- For a burst length of eight, A3-A_i select the eight-data-element block; A0-A2 select the first access within the block.
- Whenever a boundary of the block is reached within a given sequence above, the following access wraps within the block.
- $i = 9$ (512MB);
 $i = 9, 11$ (1GB)

Table 7: CAS Latency (CL) Table

SPEED	ALLOWABLE OPERATING CLOCK FREQUENCY (MHZ)	
	CL = 2	CL = 2.5
-335	$75 \leq f \leq 133$	$75 \leq f \leq 167$
-262	$75 \leq f \leq 133$	$75 \leq f \leq 133$
-26A	$75 \leq f \leq 133$	$75 \leq f \leq 133$
-265	$75 \leq f \leq 100$	$75 \leq f \leq 133$
-202	$75 \leq f \leq 100$	$75 \leq f \leq 125$

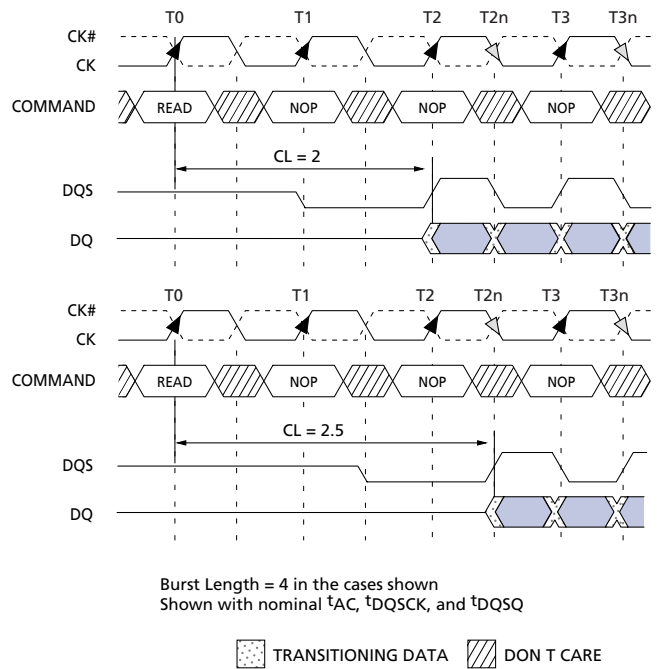
Figure 6: CAS Latency Diagram

Operating Mode

The normal operating mode is selected by issuing a MODE REGISTER SET command with bits A7–A12 each set to zero, and bits A0–A6 set to the desired values. A DLL reset is initiated by issuing a MODE REGISTER SET command with bits A7 and A9–A12 each set to zero, bit A8 set to one, and bits A0–A6 set to the desired values. Although not required by the Micron device, JEDEC specifications recommend when a LOAD MODE REGISTER command is issued to reset the DLL, it should always be followed by a LOAD MODE REGISTER command to select normal operating mode.

All other combinations of values for A7–A12 are reserved for future use and/or test modes. Test modes and reserved states should not be used because unknown operation or incompatibility with future versions may result.

Extended Mode Register

The extended mode register controls functions beyond those controlled by the mode register; these additional functions are DLL enable/disable and output drive strength. These functions are controlled via the bits shown in Figure 7, Extended Mode Register Definition Diagram, on page 11. The extended mode register is programmed via the LOAD MODE REGISTER command to the mode register (with BA0 = 1 and

BA1 = 0) and will retain the stored information until it is programmed again or the device loses power. The enabling of the DLL should always be followed by a LOAD MODE REGISTER command to the mode register (BA0/ BA1 both LOW) to reset the DLL.

The extended mode register must be loaded when all device banks are idle and no bursts are in progress, and the controller must wait the specified time before initiating any subsequent operation. Violating either of these requirements could result in unspecified operation.

DLL Enable/Disable

The DLL must be enabled for normal operation. DLL enable is required during power-up initialization and upon returning to normal operation after having disabled the DLL for the purpose of debug or evaluation. (When the device exits self refresh mode, the DLL is enabled automatically.) Any time the DLL is enabled, 200 clock cycles must occur before a READ command can be issued.

Figure 7: Extended Mode Register Definition Diagram

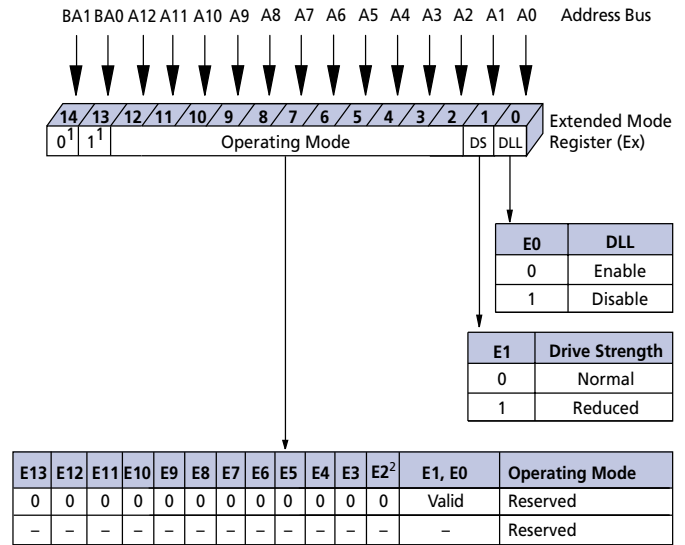

NOTE:

1. BA1 and BA0 (E14 and E13) must be "0, 1" to select the Extended Mode Register (vs. the base Mode Register).
2. The QFC# option is not supported.

Commands

The Truth Tables below provides a general reference of available commands. For a more detailed descrip-

tion of commands and operations, refer to the 256Mb or 512Mb DDR SDRAM component data sheet.

Table 8: Commands Truth Table

CKE is HIGH for all commands shown except SELF REFRESH

NAME (FUNCTION)	CS#	RAS#	CAS#	WE#	ADDR	NOTES
DESELECT (NOP)	H	X	X	X	X	1
NO OPERATION (NOP)	L	H	H	H	X	1
ACTIVE (Select bank and activate row)	L	L	H	H	Bank/Row	2
READ (Select bank and column, and start READ burst)	L	H	L	H	Bank/Col	3
WRITE (Select bank and column, and start WRITE burst)	L	H	L	L	Bank/Col	3
BURST TERMINATE	L	H	H	L	X	4
PRECHARGE (Deactivate row in bank or banks)	L	L	H	L	Code	5
AUTO REFRESH or SELF REFRESH (Enter self refresh mode)	L	L	L	H	X	6, 7
LOAD MODE REGISTER	L	L	L	L	Op-Code	8

NOTE:

1. Deselect and NOP are functionally interchangeable.
2. BA0–BA1 provide device bank address and A0–A12 provide device row address.
3. BA0–BA1 provide device bank address; A0–A9 (512MB) or A0–A9, A11 (1GB) provide device column address; A10 HIGH enables the auto precharge feature (nonpersistent), and A10 LOW disables the auto precharge feature.
4. Applies only to read bursts with auto precharge disabled; this command is undefined (and should not be used) for READ bursts with auto precharge enabled and for WRITE bursts.
5. A10 LOW: BA0-BA1 determine which device bank is precharged. A10 HIGH: all device banks are precharged and BA0–BA1 are “Don’t Care.”
6. This command is AUTO REFRESH if CKE is HIGH, SELF REFRESH if CKE is LOW.
7. Internal refresh counter controls device row addressing; all inputs and I/Os are “Don’t Care” except for CKE.
8. BA0–BA1 select either the mode register or the extended mode register (BA0 = 0, BA1 = 0 select the mode register; BA0 = 1, BA1 = 0 select extended mode register; other combinations of BA0-BA1 are reserved). A0–A12 provide the op-code to be written to the selected mode register.

Table 9: DM Operation Truth Table

Used to mask write data; provided coincident with the corresponding data

NAME (FUNCTION)	DM	DQS
WRITE Enable	L	Valid
WRITE Inhibit	H	X

Absolute Maximum Ratings

Stresses greater than those listed may cause permanent damage to the device. This is a stress rating only, and functional operation of the device at these or any other conditions above those indicated in the opera-

tional sections of this specification is not implied. Exposure to absolute maximum rating conditions for extended periods may affect reliability.

Voltage on VDD Supply	
Relative to VSS	-1V to +3.6V
Voltage on VDDQ Supply	
Relative to VSS	-1V to +3.6V
Voltage on VREF and Inputs	
Relative to VSS	-1V to +3.6V
Voltage on I/O Pins	
Relative to VSS	-0.5V to VDDQ +0.5V

Operating Temperature	
T _A (ambient)	0°C to +70°C
Storage Temperature (plastic)	-55°C to +150°C
Power Dissipation	16W
Short Circuit Output Current	50mA

Table 10: DC Electrical Characteristics and Operating Conditions

Notes: 1–5, 14; notes appear on pages 20–23; 0°C ≤ T_A ≤ +70°C

PARAMETER/CONDITION	SYMBOL	MIN	MAX	UNITS	NOTES
Supply Voltage	VDD	2.3	2.7	V	32, 36
I/O Supply Voltage	VDDQ	2.3	2.7	V	32, 36, 39
I/O Reference Voltage	VREF	0.49 × VDDQ	0.51 × VDDQ	V	6, 39
I/O Termination Voltage (system)	VTT	VREF - 0.04	VREF + 0.04	V	7, 39
Input High (Logic 1) Voltage	V _{IH} (DC)	VREF + 0.15	VDD + 0.3	V	25
Input Low (Logic 0) Voltage	V _{IL} (DC)	-0.3	VREF - 0.15	V	25
INPUT LEAKAGE CURRENT Any input 0V ≤ V _{IN} ≤ VDD, VREF pin 0V ≤ V _{IN} ≤ 1.35V (All other pins not under test = 0V)	Command/Address, RAS#, CAS#, WE#	-32	32	μA	47
	S#, CKE, CK, CK#	-16	16		
	DM	-4	4		
OUTPUT LEAKAGE CURRENT (DQs are disabled; 0V ≤ V _{OUT} ≤ VDDQ)	DQ, DQS	-10	10	μA	47
OUTPUT LEVELS High Current (V _{OUT} = VDDQ - 0.373V, minimum VREF, minimum VTT) Low Current (V _{OUT} = 0.373V, maximum VREF, maximum VTT)	I _{OH}	-16.8	–	mA	33, 34
	I _{OL}	16.8	–	mA	

Table 11: AC Input Operating Conditions

Notes: 1–5, 14; notes appear on pages 20–23; 0°C ≤ T_A ≤ +70°C; VDD = VDDQ = +2.5V ±0.2V

PARAMETER/CONDITION	SYMBOL	MIN	MAX	UNIT S	NOTES
Input High (Logic 1) Voltage	V _{IH} (AC)	VREF + 0.310	–	V	12, 25, 35
Input Low (Logic 0) Voltage	V _{IL} (AC)	–	VREF - 0.310	V	12, 25, 35
I/O Reference Voltage	VREF(AC)	0.49 × VDDQ	0.49 × VDDQ	V	6

Table 12: IDD Specifications and Conditions – 512MB

 Notes: 1–5, 8, 10, 12, 48; DDR SDRAM devices only; notes appear on pages 20–23; $0^{\circ}\text{C} \leq T_A \leq +70^{\circ}\text{C}$; $V_{DD}, V_{DDQ} = +2.5\text{V} \pm 0.2\text{V}$

PARAMETER/CONDITION	SYM	MAX				UNIT S	NOTE S	
		-335	-262	-26A/-265	-202			
OPERATING CURRENT: One device bank; Active-Precharge; $t_{RC} = t_{RC}(\text{MIN})$; $t_{CK} = t_{CK}(\text{MIN})$; DQ, DM and DQS inputs changing once per clock cycle; Address and control inputs changing once every two clock cycles	IDD0 ^a	1,032	1,032	872	992	mA	20, 42	
OPERATING CURRENT: One device bank; Active-Read-Precharge; Burst = 4; $t_{RC} = t_{RC}(\text{MIN})$; $t_{CK} = t_{CK}(\text{MIN})$; $I_{OUT} = 0\text{mA}$; Address and control inputs changing once per clock cycle	IDD1 ^a	1,392	1,312	1,192	1,272	mA	20, 42	
PRECHARGE POWER-DOWN STANDBY CURRENT: All device banks idle; Power-down mode; $t_{CK} = t_{CK}(\text{MIN})$; CKE = (LOW)	IDD2P ^b	64	64	64	64	mA	21, 28, 44	
IDLE STANDBY CURRENT: CS# = HIGH; All device banks are idle; $t_{CK} = t_{CK}(\text{MIN})$; CKE = HIGH; Address and other control inputs changing once per clock cycle. $V_{IN} = V_{REF}$ for DQ, DQS, and DM	IDD2F ^b	800	720	720	720	mA	45	
ACTIVE POWER-DOWN STANDBY CURRENT: One device bank active; Power-down mode; $t_{CK} = t_{CK}(\text{MIN})$; CKE = LOW	IDD3P ^b	480	400	400	480	mA	21, 28, 44	
ACTIVE STANDBY CURRENT: CS# = HIGH; CKE = HIGH; One device bank active; $t_{RC} = t_{RAS}(\text{MAX})$; $t_{CK} = t_{CK}(\text{MIN})$; DQ, DM and DQS inputs changing twice per clock cycle; Address and other control inputs changing once per clock cycle	IDD3N ^b	960	800	800	800	mA	41	
OPERATING CURRENT: Burst = 2; Reads; Continuous burst; One device bank active; Address and control inputs changing once per clock cycle; $t_{CK} = t_{CK}(\text{MIN})$; $I_{OUT} = 0\text{mA}$	IDD4R ^a	1,432	1,232	1,232	1,432	mA	20, 42	
OPERATING CURRENT: Burst = 2; Writes; Continuous burst; One device bank active; Address and control inputs changing once per clock cycle; $t_{CK} = t_{CK}(\text{MIN})$; DQ, DM, and DQS inputs changing twice per clock cycle	IDD4W ^a	1,272	1,112	1,122	1,552	mA	20	
AUTO REFRESH BURST CURRENT:	$t_{RC} = t_{RFC}(\text{MIN})$ $t_{RFC} = 7.8125\mu\text{s}$	IDD5 ^b	4,080	3,760	3,760	3,920	mA	20, 44
		IDD5A _b	96	96	96	96	mA	24, 44
SELF REFRESH CURRENT: CKE $\leq 0.2\text{V}$	IDD6 ^b	64	64	64	64	mA	9	
OPERATING CURRENT: Four device bank interleaving READs (Burst = 4) with auto precharge, $t_{RC} = \text{minimum } t_{RC} \text{ allowed}$; $t_{CK} = t_{CK}(\text{MIN})$; Address and control inputs change only during Active READ, or WRITE commands	IDD7 ^a	3,272	2,832	2,832	2,952	mA	20, 43	

NOTE:

- a - Value calculated as one module rank in this operating condition, and all other module ranks in IDD2p (CKE LOW) mode.
- b - Value calculated reflects all module ranks in this operating condition.

Table 13: IDD Specifications and Conditions – 1GB

 Notes: 1–5, 8, 10, 12, 48; DDR SDRAM devices only; notes appear on pages 20–23; $0^{\circ}\text{C} \leq T_A \leq +70^{\circ}\text{C}$; $V_{DD}, V_{DDQ} = +2.5\text{V} \pm 0.2\text{V}$

PARAMETER/CONDITION	SYM	MAX				UNIT S	NOTE S	
		-335	-262	-26A/-265	-202			
OPERATING CURRENT: One device bank; Active-Precharge; $t_{RC} = t_{RC}(\text{MIN})$; $t_{CK} = t_{CK}(\text{MIN})$; DQ, DM and DQS inputs changing once per clock cycle; Address and control inputs changing once every two clock cycles	IDD0	1,080	1,080	960	960	mA	20, 42	
OPERATING CURRENT: One device bank; Active-Read-Precharge; Burst = 4; $t_{RC} = t_{RC}(\text{MIN})$; $t_{CK} = t_{CK}(\text{MIN})$; $I_{OUT} = 0\text{mA}$; Address and control inputs changing once per clock cycle	IDD1	1,320	1,320	1,200	1,200	mA	20, 42	
PRECHARGE POWER-DOWN STANDBY CURRENT: All device banks idle; Power-down mode; $t_{CK} = t_{CK}(\text{MIN})$; CKE = (LOW)	IDD2P	80	80	80	80	mA	21, 28, 44	
IDLE STANDBY CURRENT: CS# = HIGH; All device banks are idle; $t_{CK} = t_{CK}(\text{MIN})$; CKE = HIGH; Address and other control inputs changing once per clock cycle. $V_{IN} = V_{REF}$ for DQ, DQS, and DM	IDD2F	720	720	640	640	mA	45	
ACTIVE POWER-DOWN STANDBY CURRENT: One device bank active; Power-down mode; $t_{CK} = t_{CK}(\text{MIN})$; CKE = LOW	IDD3P	560	560	480	480	mA	21, 28, 44	
ACTIVE STANDBY CURRENT: CS# = HIGH; CKE = HIGH; One device bank active; $t_{RC} = t_{RAS}(\text{MAX})$; $t_{CK} = t_{CK}(\text{MIN})$; DQ, DM and DQS inputs changing twice per clock cycle; Address and other control inputs changing once per clock cycle	IDD3N	720	720	640	640	mA	41	
OPERATING CURRENT: Burst = 2; Reads; Continuous burst; One device bank active; Address and control inputs changing once per clock cycle; $t_{CK} = t_{CK}(\text{MIN})$; $I_{OUT} = 0\text{mA}$	IDD4R	1,360	1,360	1,200	1,200	mA	20, 42	
OPERATING CURRENT: Burst = 2; Writes; Continuous burst; One device bank active; Address and control inputs changing once per clock cycle; $t_{CK} = t_{CK}(\text{MIN})$; DQ, DM, and DQS inputs changing twice per clock cycle	IDD4W	1,280	1,280	1,120	1,120	mA	20	
AUTO REFRESH BURST CURRENT:	$t_{RC} = t_{RFC}(\text{MIN})$	IDD5	4,640	4,640	4,480	4,480	mA	20, 44
	$t_{RC} = 7.8125\mu\text{s}$	IDD5A	160	160	160	160	mA	24, 44
SELF REFRESH CURRENT: CKE $\leq 0.2\text{V}$	IDD6	80	80	80	80	mA	9	
OPERATING CURRENT: Four device bank interleaving READs (Burst = 4) with auto precharge, $t_{RC} = \text{minimum } t_{RC} \text{ allowed}$; $t_{CK} = t_{CK}(\text{MIN})$; Address and control inputs change only during Active READ, or WRITE commands	IDD7	3,280	3,240	2,840	2,840	mA	20, 43	

NOTE:

- a - Value calculated as one module rank in this operating condition, and all other module ranks in IDD2p (CKE LOW) mode.
- b - Value calculated reflects all module ranks in this operating condition.

Table 14: Capacitance

Note: 11; notes appear notes appear on pages 20–23

PARAMETER	SYMBOL	MIN	MAX	UNITS
Input/Output Capacitance: DQ, DQS, DM	C _{IO}	7	9	pF
Input Capacitance: Command and Address, RAS#, CAS#, WE#	C _{I1}	24	40	pF
Input Capacitance: CK, CK#, CKE, S#	C _{I2}	12	20	pF

Table 15: DDR SDRAM Component Electrical Characteristics and Recommended AC Operating Conditions (-335, -262)

 Notes: 1–5, 12–15, 29, 40; notes appear on pages 20–23; 0°C ≤ T_A ≤ +70°C; V_{DD} = V_{DDQ} = +2.5V ±0.2V

AC CHARACTERISTICS		-335		-262		UNITS	NOTES
PARAMETER	SYMBOL	MIN	MAX	MIN	MAX		
Access window of DQs from CK/CK#	t _{AC}	-0.70	+0.70	-0.75	+0.75	ns	
CK high-level width	t _{CH}	0.45	0.55	0.45	0.55	t _{CK}	26
CK low-level width	t _{CL}	0.45	0.55	0.45	0.55	t _{CK}	26
Clock cycle time	CL=2.5 t _{CK} (2.5)	6	13	7.5	13	ns	40, 46
	CL=2 t _{CK} (2)	7.5	13	7.5	13	ns	40, 46
DQ and DM input hold time relative to DQS	t _{DH}	0.45		0.5		ns	23, 27
DQ and DM input setup time relative to DQS	t _{DS}	0.45		0.5		ns	23, 27
DQ and DM input pulse width (for each input)	t _{DIPW}	1.75		1.75		ns	27
Access window of DQS from CK/CK#	t _{DQSK}	-0.60	+0.60	-0.75	+0.75	ns	
DQS input high pulse width	t _{DQSH}	0.35		0.35		t _{CK}	
DQS input low pulse width	t _{DQSL}	0.35		0.35		t _{CK}	
DQS-DQ skew, DQS to last DQ valid, per group, per access	t _{DQSQ}		0.4		0.5	ns	22, 23
Write command to first DQS latching transition	t _{DQSS}	0.75	1.25	0.75	1.25	t _{CK}	
DQS falling edge to CK rising - setup time	t _{DSS}	0.20		0.20		t _{CK}	
DQS falling edge from CK rising - hold time	t _{DSH}	0.20		0.20		t _{CK}	
Half clock period	t _{HP}	t _{CH} , t _{CL}		t _{CH} , t _{CL}		ns	8
Data-out high-impedance window from CK/CK#	t _{HZ}		+0.70		+0.75	ns	16, 37
Data-out low-impedance window from CK/CK#	t _{LZ}	-0.70		-0.75		ns	16, 38
Address and control input hold time (fast slew rate)	t _{IHF}	0.75		0.90		ns	12
Address and control input setup time (fast slew rate)	t _{ISF}	0.75		0.90		ns	12
Address and control input hold time (slow slew rate)	t _{IHS}	0.8		1		ns	12
Address and control input setup time (slow slew rate)	t _{ISs}	0.8		1		ns	12
Address and Control input pulse width (for each input)	t _{IPW}	2.2		2.2		ns	
LOAD MODE REGISTER command cycle time	t _{MRD}	12		15		ns	
DQ-DQS hold, DQS to first DQ to go non-valid, per access	t _{QH}	t _{HP} - t _{QHS}		t _{HP} - t _{QHS}		ns	22, 23
Data hold skew factor	t _{QHS}		0.75		0.75	ns	
ACTIVE to PRECHARGE command	t _{RAS}	42	70,000	40	120,000	ns	31
ACTIVE to READ with Auto precharge command	t _{RAP}	18		15		ns	

Table 15: DDR SDRAM Component Electrical Characteristics and Recommended AC Operating Conditions (-335, -262) (Continued)

 Notes: 1–5, 12–15, 29, 40; notes appear on pages 20–23; $0^{\circ}\text{C} \leq T_A \leq +70^{\circ}\text{C}$; $V_{DD} = V_{DDQ} = +2.5\text{V} \pm 0.2\text{V}$

AC CHARACTERISTICS		-335		-262		UNITS	NOTES
PARAMETER	SYMBOL	MIN	MAX	MIN	MAX		
ACTIVE to ACTIVE/AUTO REFRESH command period	t_{RC}	60		60		ns	
AUTO REFRESH command period	t_{RFC}	72		75		ns	44
ACTIVE to READ or WRITE delay	t_{RCD}	18		15		ns	
PRECHARGE command period	t_{RP}	18		15		ns	
DQS read preamble	t_{RPRE}	0.9	1.1	0.9	1.1	t_{CK}	37
DQS read postamble	t_{RPST}	0.4	0.6	0.4	0.6	t_{CK}	
ACTIVE bank <i>a</i> to ACTIVE bank <i>b</i> command	t_{RRD}	12		15		ns	
DQS write preamble	t_{WPRE}	0.25		0.25		t_{CK}	
DQS write preamble setup time	t_{WPRES}	0		0		ns	18, 19
DQS write postamble	t_{WPST}	0.4	0.6	0.4	0.6	t_{CK}	17
Write recovery time	t_{WR}	15		15		ns	
Internal WRITE to READ command delay	t_{WTR}	1		1		t_{CK}	
Data valid output window	NA	$t_{QH} - t_{DQSQ}$		$t_{QH} - t_{DQSQ}$		ns	22
REFRESH to REFRESH command interval	t_{REFC}		70.3		70.3	μs	21
Average periodic refresh interval	t_{REFI}		7.8		7.8	μs	21
Terminating voltage delay to V_{DD}	t_{VTD}	0		0		ns	
Exit SELF REFRESH to non-READ command	t_{XSNR}	75		75		ns	
Exit SELF REFRESH to READ command	t_{XSRD}	200		200		t_{CK}	

Table 16: DDR SDRAM Component Electrical Characteristics and Recommended AC Operating Conditions (-26A, -265, -202)

 Notes: 1–5, 12–15, 29, 40; notes appear on pages 20–23; $0^{\circ}\text{C} \leq T_A \leq +70^{\circ}\text{C}$; $V_{DD} = V_{DDQ} = +2.5\text{V} \pm 0.2\text{V}$

AC CHARACTERISTICS		-26A		-265		-202		UNITS	NOTES
PARAMETER	SYMBOL	MIN	MAX	MIN	MAX	MIN	MAX		
Access window of DQs from CK/CK#	t_{AC}	-0.75	+0.75	-0.75	+0.75	-0.8	+0.8	ns	
CK high-level width	t_{CH}	0.45	0.55	0.45	0.55	0.45	0.55	t_{CK}	26
CK low-level width	t_{CL}	0.45	0.55	0.45	0.55	0.45	0.55	t_{CK}	26
Clock cycle time	CL=2.5 $t_{CK} (2.5)$	7.5	13	7.5	13	8	13	ns	40, 46
	CL=2 $t_{CK} (2)$	7.5	13	10	13	10	13	ns	40, 46
DQ and DM input hold time relative to DQS	t_{DH}	0.5		0.5		0.6		ns	23, 27
DQ and DM input setup time relative to DQS	t_{DS}	0.5		0.5		0.6		ns	23, 27
DQ and DM input pulse width (for each input)	t_{DIPW}	1.75		1.75		2		ns	27
Access window of DQS from CK/CK#	t_{DQSCK}	-0.75	+0.75	-0.75	+0.75	-0.8	+0.8	ns	
DQS input high pulse width	t_{DQSH}	0.35		0.35		0.35		t_{CK}	
DQS input low pulse width	t_{DQSL}	0.35		0.35		0.35		t_{CK}	
DQS-DQ skew, DQS to last DQ valid, per group, per access	t_{DQSQ}		0.5		0.5		0.6	ns	22, 23
Write command to first DQS latching transition	t_{DQSS}	0.75	1.25	0.75	1.25	0.75	1.25	t_{CK}	
DQS falling edge to CK rising - setup time	t_{DSS}	0.20		0.20		0.20		t_{CK}	
DQS falling edge from CK rising - hold time	t_{DSH}	0.20		0.20		0.20		t_{CK}	
Half clock period	t_{HP}	t_{CH}, t_{CL}		t_{CH}, t_{CL}		t_{CH}, t_{CL}		ns	8
Data-out high-impedance window from CK/CK#	t_{HZ}		+0.75		+0.75		+0.8	ns	16, 37
Data-out low-impedance window from CK/CK#	t_{LZ}	-0.75		-0.75		-0.8		ns	16, 38
Address and control input hold time (fast slew rate)	t_{IH_F}	0.90		0.90		1.1		ns	12
Address and control input setup time (fast slew rate)	t_{IS_F}	.900		0.90		1.1		ns	12
Address and control input hold time (slow slew rate)	t_{IH_S}	1		1		1.1		ns	12
Address and control input setup time (slow slew rate)	t_{IS_S}	1		1		1.1		ns	12
Address and Control input pulse width (for each input)	t_{IPW}	2.2		2.2		2.2		ns	
LOAD MODE REGISTER command cycle time	t_{MRD}	15		15		16		ns	
DQ-DQS hold, DQS to first DQ to go non-valid, per access	t_{QH}	$t_{HP} - t_{QHS}$		$t_{HP} - t_{QHS}$		$t_{HP} - t_{QHS}$		ns	22, 23
Data hold skew factor	t_{QHS}		0.75		0.75		1	ns	
ACTIVE to PRECHARGE command	t_{RAS}	40	120,000	40	120,000	40	120,000	ns	31
ACTIVE to READ with Auto precharge command	t_{RAP}	20		20		20		ns	
ACTIVE to ACTIVE/AUTO REFRESH command period	t_{RC}	65		65		70		ns	
AUTO REFRESH command period	t_{RFC}	75		75		80		ns	44
ACTIVE to READ or WRITE delay	t_{RCD}	20		20		20		ns	
PRECHARGE command period	t_{RP}	20		20		20		ns	

Table 16: DDR SDRAM Component Electrical Characteristics and Recommended AC Operating Conditions (-26A, -265, -202) (Continued)

 Notes: 1–5, 12–15, 29, 40; notes appear on pages 20–23; $0^{\circ}\text{C} \leq T_A \leq +70^{\circ}\text{C}$; $V_{DD} = V_{DDQ} = +2.5\text{V} \pm 0.2\text{V}$

AC CHARACTERISTICS		-26A		-265		-202		UNITS	NOTES
PARAMETER	SYMBOL	MIN	MAX	MIN	MAX	MIN	MAX		
DQS read preamble	t_{RPRE}	0.9	1.1	0.9	1.1	0.9	1.1	t_{CK}	37
DQS read postamble	t_{RPST}	0.4	0.6	0.4	0.6	0.4	0.6	t_{CK}	
ACTIVE bank <i>a</i> to ACTIVE bank <i>b</i> command	t_{RRD}	15		15		15		ns	
DQS write preamble	t_{WPRE}	0.25		0.25		0.25		t_{CK}	
DQS write preamble setup time	t_{WPRES}	0		0		0		ns	18, 19
DQS write postamble	t_{WPST}	0.4	0.6	0.4	0.6	0.4	0.6	t_{CK}	17
Write recovery time	t_{WR}	15		15		15		ns	
Internal WRITE to READ command delay	t_{WTR}	1		1		1		t_{CK}	
Data valid output window	NA	$t_{QH} - t_{DQSQ}$		$t_{QH} - t_{DQSQ}$		$t_{QH} - t_{DQSQ}$		ns	22
REFRESH to REFRESH command interval	t_{REFC}		70.3		70.3		70.3	μs	21
Average periodic refresh interval	t_{REFI}		7.8		7.8		7.8	μs	21
Terminating voltage delay to V_{DD}	t_{VTD}	0		0		0		ns	
Exit SELF REFRESH to non-READ command	t_{XSNR}	75		75		80		ns	
Exit SELF REFRESH to READ command	t_{XSRD}	200		200		200		t_{CK}	

Notes

1. All voltages referenced to VSS.
2. Tests for AC timing, I_{DD} , and electrical AC and DC characteristics may be conducted at nominal reference/supply voltage levels, but the related specifications and device operation are guaranteed for the full voltage range specified.
3. Outputs measured with equivalent load:

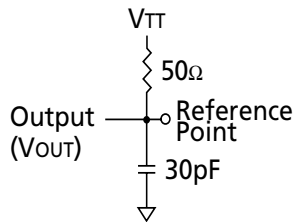

4. AC timing and I_{DD} tests may use a V_{IL} -to- V_{IH} swing of up to 1.5V in the test environment, but input timing is still referenced to V_{REF} (or to the crossing point for CK/CK#), and parameter specifications are guaranteed for the specified AC input levels under normal use conditions. The minimum slew rate for the input signals used to test the device is 1V/ns in the range between $V_{IL}(AC)$ and $V_{IH}(AC)$.
5. The AC and DC input level specifications are as defined in the SSTL_2 Standard (i.e., the receiver will effectively switch as a result of the signal crossing the AC input level, and will remain in that state as long as the signal does not ring back above [below] the DC input LOW [HIGH] level).
6. V_{REF} is expected to equal $V_{DDQ}/2$ of the transmitting device and to track variations in the DC level of the same. Peak-to-peak noise (non-common mode) on V_{REF} may not exceed ± 2 percent of the DC value. Thus, from $V_{DDQ}/2$, V_{REF} is allowed $\pm 25mV$ for DC error and an additional $\pm 25mV$ for AC noise. This measurement is to be taken at the nearest V_{REF} bypass capacitor.
7. V_{TT} is not applied directly to the device. V_{TT} is a system supply for signal termination resistors, is expected to be set equal to V_{REF} and must track variations in the DC level of V_{REF} .
8. I_{DD} is dependent on output loading and cycle rates. Specified values are obtained with minimum cycle time at $CL = 2$ for -262, -26A, and -202, $CL = 2.5$ for -335 and -265 with the outputs open.
9. Enables on-chip refresh and address counters.
10. I_{DD} specifications are tested after the device is properly initialized, and is averaged at the defined cycle rate.
11. This parameter is sampled. $V_{DD} = +2.5V \pm 0.2V$, $V_{DDQ} = +2.5V \pm 0.2V$, $V_{REF} = V_{SS}$, $f = 100$ MHz, = $25^\circ C$, $V_{OUT}(DC) = V_{DDQ}/2$, V_{OUT} (peak to peak) $T_A = 0.2V$. DM input is grouped with I/O pins, reflecting the fact that they are matched in loading.
12. Command/Address input slew rate = 0.5V/ns. For -262, -26A, and -265 with slew rates 1V/ns and faster, t_{IS} and t_{IH} are reduced to 900ps; for -335, they are reduced to 750ps. If the slew rate is less than 0.5 V/ns, timing must be derated: t_{IS} has an additional 50ps per each 100mV/ns reduction in slew rate from the 500mV/ns, while t_{IH} remains constant. If the slew rate exceeds 4.5V/ns, functionality is uncertain.
13. The CK/CK# input reference level (for timing referenced to CK/CK#) is the point at which CK and CK# cross; the input reference level for signals other than CK/CK# is V_{REF} .
14. Inputs are not recognized as valid until V_{REF} stabilizes. Exception: during the period before V_{REF} stabilizes, $CKE \leq 0.3 \times V_{DDQ}$ is recognized as LOW.
15. The output timing reference level, as measured at the timing reference point indicated in Note 3, is V_{TT} .
16. tHZ and t_{LZ} transitions occur in the same access time windows as valid data transitions. These parameters are not referenced to a specific voltage level, but specify when the device output is no longer driving (HZ) or begins driving (LZ).
17. The intent of the Don't Care state after completion of the postamble is the DQS-driven signal should either be high, low, or high-Z and that any signal transition within the input switching region must follow valid input requirements. That is, if DQS transitions high (above V_{IH} DC (MIN)) then it must not transition low (below V_{IH} DC) prior to t_{DQSH} (MIN).
18. This is not a device limit. The device will operate with a negative value, but system performance could be degraded due to bus turnaround.
19. It is recommended that DQS be valid (HIGH or LOW) on or before the WRITE command. The case shown (DQS going from High-Z to logic LOW) applies when no WRITES were previously in progress on the bus. If a previous WRITE was in progress, DQS could be HIGH during this time, depending on t_{DQSS} .
20. MIN (t_{RC} or t_{RFC}) for I_{DD} measurements is the smallest multiple of t_{CK} that meets the minimum absolute Value for the respective parameter. t_{RAS} (MAX) for I_{DD} measurements is the largest multi-

- ple of t_{CK} that meets the maximum absolute value for t_{RAS} .
21. The refresh period 64ms. This equates to an average refresh rate of 7.8125 μ s. However, an AUTO REFRESH command must be asserted at least once every 70.3 μ s; burst refreshing or posting by the DRAM controller greater than eight refresh cycles is not allowed.
 22. The valid data window is derived by achieving other specifications: t_{HP} ($t_{CK}/2$), t_{DQSQ} , and t_{QH} ($t_{QH} = t_{HP} - t_{QHS}$). The data valid window derates directly proportional with the clock duty cycle and a practical data valid window can be derived. The clock is allowed a maximum duty cycle variation of 45/55. Functionality is uncertain when operating beyond a 45/55 ratio. Figure 8, Derating Data Valid Window, shows derating curves for duty cycles ranging between 50/50 and 45/55.
 23. Each byte lane has a corresponding DQS.
 24. This limit is actually a nominal value and does not result in a fail value. CKE is HIGH during REFRESH command period (t_{RFC} [MIN]) else CKE is LOW (i.e., during standby).
 25. To maintain a valid level, the transitioning edge of the input must:
 - a. Sustain a constant slew rate from the current AC level through to the target AC level, $V_{IL}(AC)$ or $V_{IH}(AC)$.
 - b. Reach at least the target AC level.
 - c. After the AC target level is reached, continue to maintain at least the target DC level, $V_{IL}(DC)$ or $V_{IH}(DC)$.
 26. JEDEC specifies CK and CK# input slew rate must be $\geq 1V/ns$ (2V/ns differentially).
 27. DQ and DM input slew rates must not deviate from DQS by more than 10 percent. If the DQ/DM/DQS slew rate is less than 0.5V/ns, timing must be derated: 50ps must be added to t_{DS} and t_{DH} for each 100mv/ns reduction in slew rate. If slew rate exceeds 4V/ns, functionality is uncertain.
 28. VDD must not vary more than 4 percent if CKE is not active while any bank is active.
 29. The clock is allowed up to $\pm 150ps$ of jitter. Each timing parameter is allowed to vary by the same amount.

Figure 8: Derating Data Valid Window

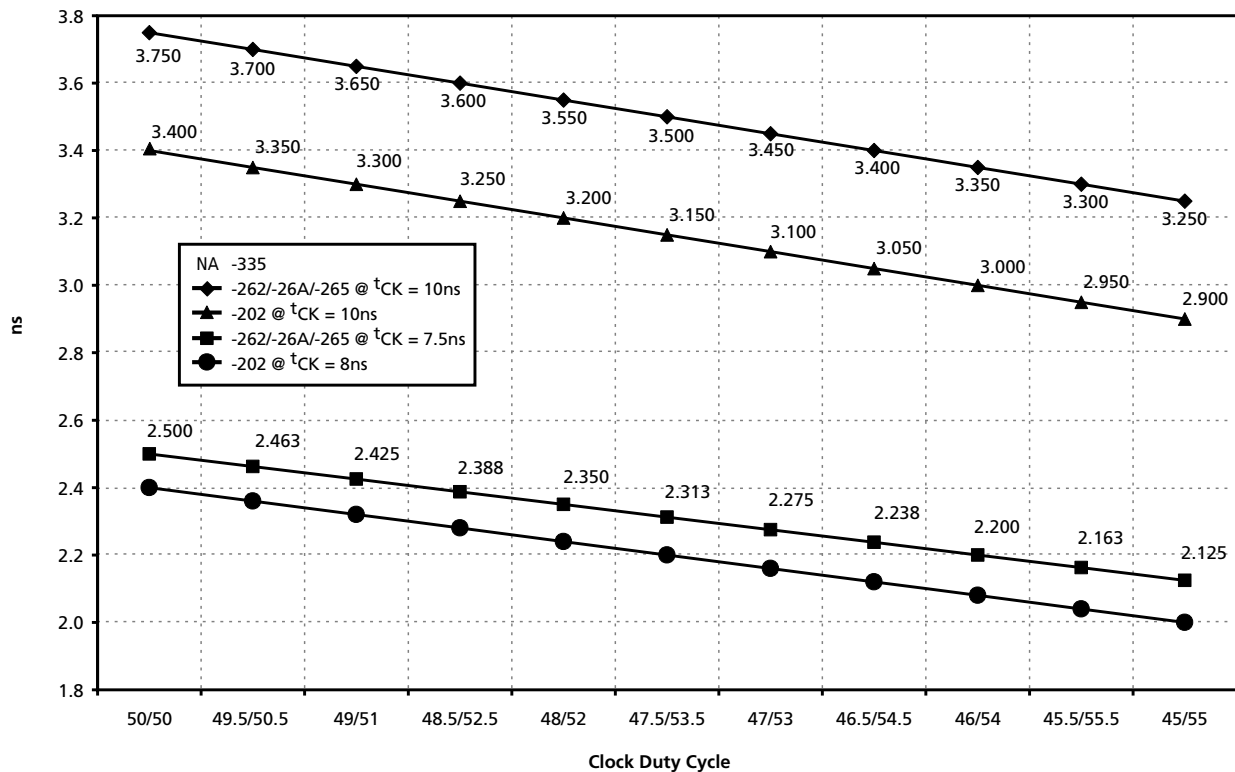

30. t_{HP} min is the lesser of t_{CL} minimum and t_{CH} minimum actually applied to the device CK and CK# inputs, collectively during bank active.
31. READs and WRITEs with auto precharge are not allowed to be issued until $t_{RAS}(MIN)$ can be satisfied prior to the internal precharge command being issued.
32. Any positive glitch must be less than 1/3 of the clock and not more than +400mV or 2.9V, whichever is less. Any negative glitch must be less than 1/3 of the clock cycle and not exceed either -300mV or 2.2V, whichever is more positive.
33. Normal Output Drive Curves:
 - a. The full variation in driver pull-down current from minimum to maximum process, temperature and voltage will lie within the outer bounding lines of the V-I curve of Figure 9, Pull-Down Characteristics.
 - b. The variation in driver pull-down current within nominal limits of voltage and temperature is expected, but not guaranteed, to lie within the inner bounding lines of the V-I curve of Figure 9, Pull-Down Characteristics.
 - c. The full variation in driver pull-up current from minimum to maximum process, temperature and voltage will lie within the outer bounding lines of the V-I curve of Figure 10, Pull-Up Characteristics.
 - d. The variation in driver pull-up current within nominal limits of voltage and temperature is expected, but not guaranteed, to lie within the inner bounding lines of the V-I curve of Figure 10, Pull-Up Characteristics.
 - e. The full variation in the ratio of the maximum to minimum pull-up and pull-down current should be between 0.71 and 1.4, for device drain-to-source voltages from 0.1V to 1.0V, and at the same voltage and temperature.
 - f. The full variation in the ratio of the nominal pull-up to pull-down current should be unity ± 10 percent, for device drain-to-source voltages from 0.1V to 1.0V.
34. The voltage levels used are derived from a minimum VDD level and the referenced test load. In practice, the voltage levels obtained from a properly terminated bus will provide significantly different voltage values.
35. V_{IH} overshoot: $V_{IH}(MAX) = V_{DDQ} + 1.5V$ for a pulse width $\leq 3ns$ and the pulse width can not be greater than 1/3 of the cycle rate. V_{IL} undershoot: $V_{IL}(MIN) = -1.5V$ for a pulse width $\leq 3ns$ and the pulse width can not be greater than 1/3 of the cycle rate.
36. VDD and VDDQ must track each other.
37. This maximum value is derived from the referenced test load. In practice, the values obtained in a typical terminated design may reflect up to 310ps less for $t_{HZ}(MAX)$ and the last DVW. $t_{HZ}(MAX)$ will prevail over $t_{DQSCK}(MAX) + t_{RPST}(MAX)$ condition. $t_{LZ}(MIN)$ will prevail over $t_{DQSCK}(MIN) + t_{RPRE}(MAX)$ condition.
38. For slew rates greater than 1V/ns the (LZ) transition will start about 310ps earlier.
39. During Initialization, VDDQ, VTT, and VREF must be equal to or less than $V_{DD} + 0.3V$. Alternatively, VTT may be 1.35V maximum during power up, even if V_{DD}/V_{DDQ} are 0.0V, provided a minimum of 42 Ω of series resistance is used between the VTT supply and the input pin.
40. The current Micron part operates below the slowest JEDEC operating frequency of 83 MHz. As such, future die may not reflect this option.

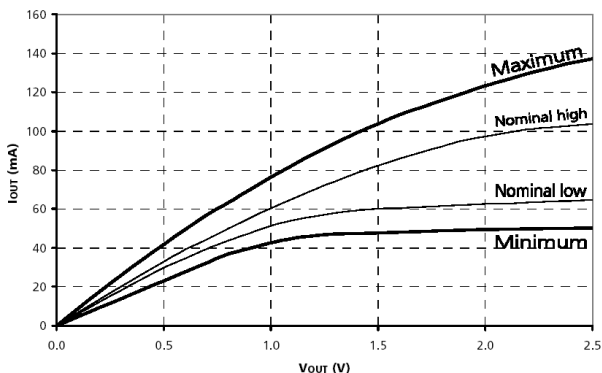
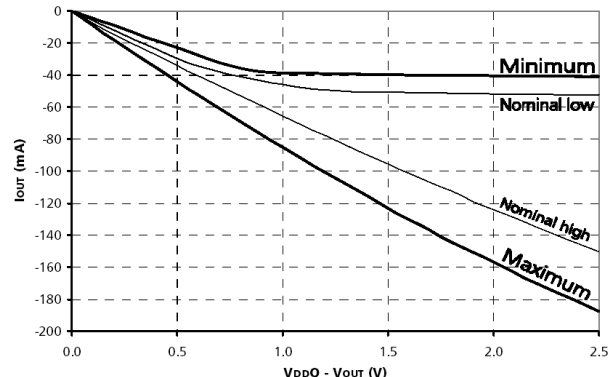
Figure 9: Pull-Down Characteristics

Figure 10: Pull-Up Characteristics

41. For -265, -26A, -262 and -335, IDD3N is specified to be 35mA at 100 MHz.
42. Random addressing changing and 50 percent of data changing at every transfer.
43. Random addressing changing and 100 percent of data changing at every transfer.
44. CKE must be active (high) during the entire time a refresh command is executed. That is, from the time the AUTO REFRESH command is registered, CKE must be active at each rising clock edge, until t_{REF} later.
45. IDD2N specifies the DQ, DQS, and DM to be driven to a valid high or low logic level. IDD2Q is similar to IDD2F except IDD2Q specifies the address and control inputs to remain stable. Although IDD2F, IDD2N, and IDD2Q are similar, IDD2F is “worst case.”
46. Whenever the operating frequency is altered, not including jitter, the DLL is required to be reset. This is followed by 200 clock cycles.
47. Leakage number reflects the worst case leakage possible through the module pin, not what each memory device contributes.
48. When an input signal is HIGH or LOW, it is defined as a steady state logic HIGH or LOW.

SPD Clock and Data Conventions

Data states on the SDA line can change only during SCL LOW. SDA state changes during SCL HIGH are reserved for indicating start and stop conditions (as shown in Figure 11, Data Validity, and Figure 12, Definition of Start and Stop).

SPD Start Condition

All commands are preceded by the start condition, which is a HIGH-to-LOW transition of SDA when SCL is HIGH. The SPD device continuously monitors the SDA and SCL lines for the start condition and will not respond to any command until this condition has been met.

SPD Stop Condition

All communications are terminated by a stop condition, which is a LOW-to-HIGH transition of SDA when SCL is HIGH. The stop condition is also used to place the SPD device into standby power mode.

SPD Acknowledge

Acknowledge is a software convention used to indicate successful data transfers. The transmitting device, either master or slave, will release the bus after transmitting eight bits. During the ninth clock cycle, the receiver will pull the SDA line LOW to acknowledge that it received the eight bits of data (as shown in Figure 13, Acknowledge Response From Receiver).

The SPD device will always respond with an acknowledge after recognition of a start condition and its slave address. If both the device and a WRITE operation have been selected, the SPD device will respond with an acknowledge after the receipt of each subsequent eight-bit word. In the read mode the SPD device will transmit eight bits of data, release the SDA line and monitor the line for an acknowledge. If an acknowledge is detected and no stop condition is generated by the master, the slave will continue to transmit data. If an acknowledge is not detected, the slave will terminate further data transmissions and await the stop condition to return to standby power mode.

Figure 11: Data Validity

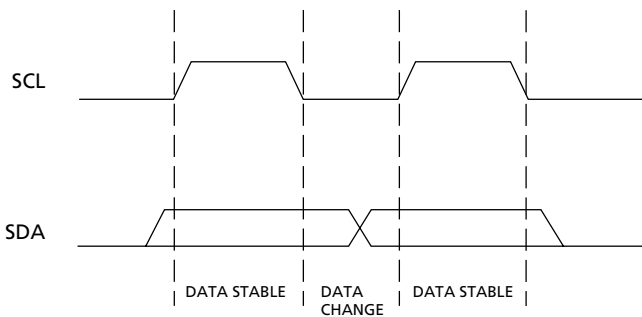

Figure 12: Definition of Start and Stop

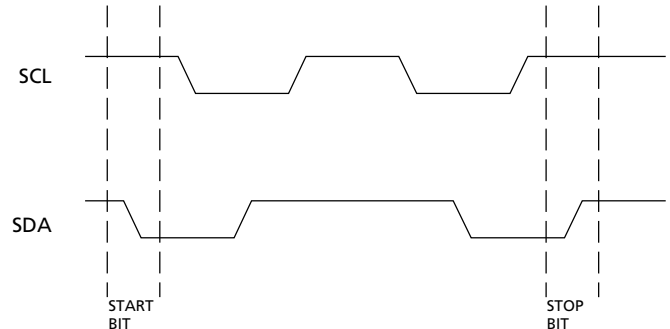

Figure 13: Acknowledge Response From Receiver

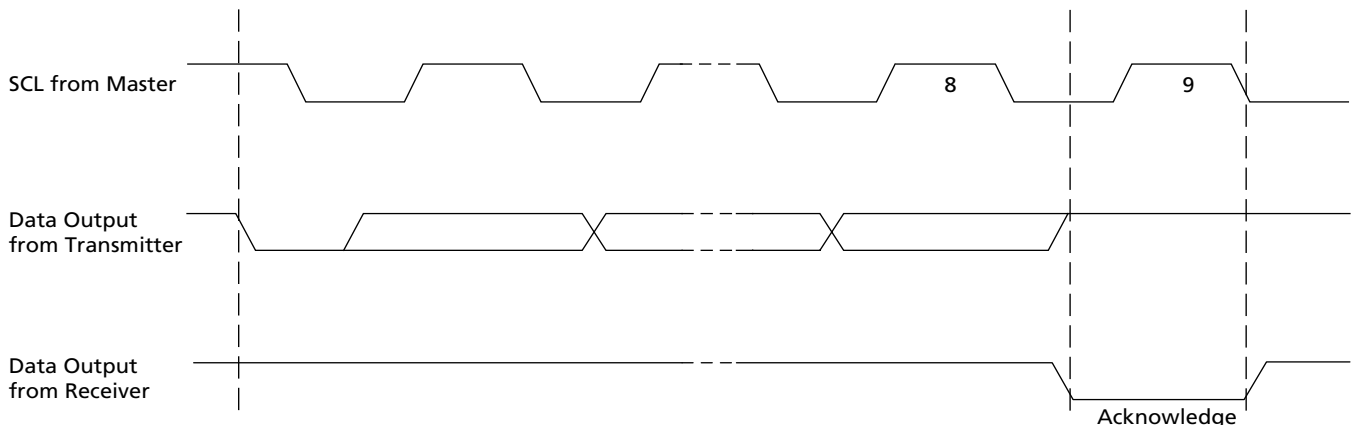

Table 17: EEPROM Device Select Code

Most significant bit (b7) is sent first.

SELECT CODE	DEVICE TYPE IDENTIFIER				CHIP ENABLE			RW
	b7	b6	b5	b4	b3	b2	b1	B0
Memory Area Select Code (two arrays)	1	0	1	0	SA2	SA1	SA0	\overline{RW}
Protection Register Select Code	0	1	1	0	SA2	SA1	SA0	\overline{RW}

Table 18: EEPROM Operating Modes

MODE	\overline{RW} BIT	\overline{WC}	BYTES	INITIAL SEQUENCE
Current Address Read	1	V_{IH} or V_{IL}	1	START, Device Select, $\overline{RW} = '1'$
Random Address Read	0	V_{IH} or V_{IL}	1	START, Device Select, $\overline{RW} = '0'$, Address
	1	V_{IH} or V_{IL}	1	reSTART, Device Select, $\overline{RW} = '1'$
Sequential Read	1	V_{IH} or V_{IL}	≥ 1	Similar to Current or Random Address Read
Byte Write	0	V_{IL}	1	START, Device Select, $\overline{RW} = '0'$
Page Write	0	V_{IL}	≤ 16	START, Device Select, $\overline{RW} = '0'$

Figure 14: SPD EEPROM Timing Diagram

Table 19: Serial Presence-Detect EEPROM DC Operating Conditions

All voltages referenced to VSS; VDDSPD = +2.3V to +3.6V

PARAMETER/CONDITION	SYMBOL	MIN	MAX	UNITS
SUPPLY VOLTAGE	VDDSPD	2.3	3.6	V
INPUT HIGH VOLTAGE: Logic 1; All inputs	V _{IH}	V _{DD} × 0.7	V _{DD} + 0.5	V
INPUT LOW VOLTAGE: Logic 0; All inputs	V _{IL}	-1	V _{DD} × 0.3	V
OUTPUT LOW VOLTAGE: I _{OUT} = 3mA	V _{OL}	-	0.4	V
INPUT LEAKAGE CURRENT: V _{IN} = GND to V _{DD}	I _{LI}	-	10	μA
OUTPUT LEAKAGE CURRENT: V _{OUT} = GND to V _{DD}	I _{LO}	-	10	μA
STANDBY CURRENT: SCL = SDA = V _{DD} - 0.3V; All other inputs = V _{DD} or V _{SS}	I _{SB}	-	30	μA
POWER SUPPLY CURRENT: SCL clock frequency = 100 KHz	I _{CC}	-	2	mA

Table 20: Serial Presence-Detect EEPROM AC Operating Conditions

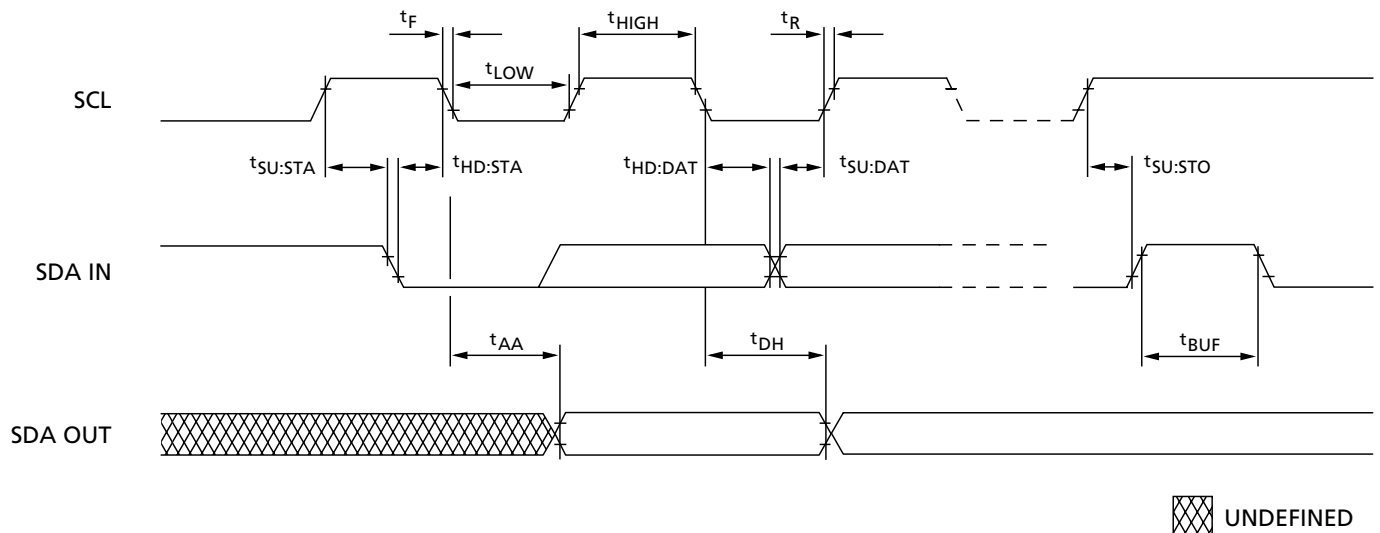
All voltages referenced to VSS; VDDSPD = +2.3V TO +3.6V

PARAMETER/CONDITION	SYMBOL	MIN	MAX	UNITS	NOTES
SCL LOW to SDA data-out valid	t _{AA}	0.2	0.9	μs	1
Time the bus must be free before a new transition can start	t _{BUF}	1.3		μs	
Data-out hold time	t _{DH}	200		ns	
SDA and SCL fall time	t _F		300	ns	2
Data-in hold time	t _{HD:DAT}	0		μs	
Start condition hold time	t _{HD:STA}	0.6		μs	
Clock HIGH period	t _{HIGH}	0.6		μs	
Noise suppression time constant at SCL, SDA inputs	t _I		50	ns	
Clock LOW period	t _{LOW}	1.3		μs	
SDA and SCL rise time	t _R		0.3	μs	2
SCL clock frequency	f _{SCL}		400	KHz	
Data-in setup time	t _{SU:DAT}	100		ns	
Start condition setup time	t _{SU:STA}	0.6		μs	3
Stop condition setup time	t _{SU:STO}	0.6		μs	
WRITE cycle time	t _{WRC}		10	ms	4

NOTE:

1. To avoid spurious START and STOP conditions, a minimum delay is placed between SCL=1 and the falling or rising edge of SDA.
2. This parameter is sampled.
3. For a reSTART condition, or following a WRITE cycle.
4. The SPD EEPROM WRITE cycle time (t_{WRC}) is the time from a valid stop condition of a write sequence to the end of the EEPROM internal erase/program cycle. During the WRITE cycle, the EEPROM bus interface circuit is disabled, SDA remains HIGH due to pull-up resistor, and the EEPROM does not respond to its slave address.

Table 21: Serial Presence-Detect Matrix

"1"/"0": Serial Data, "driven to HIGH"/"driven to LOW"; notes appear on page 29

BYTE	DESCRIPTION	ENTRY (VERSION)	MT16VDDF6464H	MT16VDDF12864H
0	Number of Bytes Used by Micron	128	80	80
1	Total Number of Bytes in SPD Device	256	08	08
2	Fundamental Memory Type	SDRAM DDR	07	07
3	Number of Rows Addresses on Assembly	13	0D	0D
4	Number of Column Addresses on Assembly	11, 12	0A	0B
5	Number of Physical Ranks on DIMM	2	02	02
6	Module Data With	64	40	40
7	Module Data With (Continued)	0	00	00
8	Module Voltage Interface Levels	SSTL 2.5V	04	04
9	SDRAM Cycle Time, (t_{CK}), CAS Latency = 2.5 (See note 1)	6ns (-335) 7ns (-262/-26A) 7.5ns (-265) 8ns (-202)	60 70 75 80	60 70 75 80
10	SDRAM Access From Clock, (t_{AC}), CAS Latency = 2.5	0.7ns (-335) 0.75ns (-262/-26A/-265) 0.8ns (-202)	70 75 80	70 75 80
11	Module Configuration Type	Non-ECC	00	00
12	Refresh Rate/Type	7.8 μ s/SELF	82	82
13	SDRAM Device Width (Primary SDRAM)	x8	08	08
14	Error-checking SDRAM Data Width	Non-ECC	00	00
15	Minimum Clock Delay, Back-to-Back Random Column Access	1 clock	01	01
16	Burst Lengths Supported	2, 4, 8	0E	0E
17	Number of Banks on SDRAM Device	4	04	04
18	CAS Latencies Supported	2, 2.5	0C	0C
19	CS Latency	0	01	01
20	WE Latency	1	02	02
21	SDRAM Module Attributes	Unbuffered/Diff. Clock	20	20
22	SDRAM Device Attributes: General	Fast/Concurrent AP	C0	C0
23	SDRAM Cycle Time, (t_{CK}), CAS Latency = 2 (See note 1)	7.5ns (-335/-262/-26A) 10ns (-265/-202)	75 A0	75 A0
24	SDRAM Access From CK, (t_{AC}), CAS Latency = 2	0.7ns (-335) 0.75ns (-262/-26A/-265) 0.8ns (-202)	70 75 80	70 75 80
25	SDRAM Cycle Time, (t_{CK}), CAS Latency = 1.5	N/A	00	00
26	SDRAM Access From CK, (t_{AC}), CAS Latency = 1.5	N/A	00	00
27	Minimum Row Precharge Time, (t_{RP})	18ns (-335) 15ns (-262) 20ns (-26A/-265/-202)	48 3C 50	48 3C 50
28	Minimum Row to Row Active, (t_{RRD})	12ns (-335) 15 ns (-262/-26A/-265/-202)	30 3C	30 3C
29	Minimum RAS# to CAS# Delay, (t_{RCD})	18ns (-335) 15ns (-262) 20ns (-26A/-265/-202)	48 3C 50	48 3C 50

Table 21: Serial Presence-Detect Matrix (Continued)

"1"/"0": Serial Data, "driven to HIGH"/"driven to LOW"; notes appear on page 29

BYTE	DESCRIPTION	ENTRY (VERSION)	MT16VDDF6464H	MT16VDDF12864H
30	Minimum RAS# Pulse Width, (^t RAS) (See note 2)	42ns (-335) 45ns (-262/-26A/-265) 40ns (-202)	2A 2D 28	2A 2D 28
31	Module Rank Density	256MB, 512MB	40	80
32	Address and Command Setup Time, (^t IS) (See note 3)	0.8ns (-335) 1ns (-262/-26A/-265) 1.1ns (-202)	80 A0 B0	80 A0 B0
33	Address and Command Hold Time, (^t IH) (See note 3)	0.8ns (-335) 1ns (-262/-26A/-265) 1.1ns (-202)	80 A0 B0	80 A0 B0
34	Data/ Data Mask Input Setup Time, (^t DS)	0.45ns (-335) 0.5ns (-262/-26A/-265) 0.6ns (-202)	45 50 60	45 50 60
35	Data/ Data Mask Input Hold Time, (^t DH)	0.45ns (-335) 0.5ns (-262/-26A/-265) 0.6ns (-202)	45 50 60	45 50 60
36-40	Reserved		00	00
41	Minimum Active Auto Refresh Time (^t RC)	60ns (-335/-262) 65ns (-26A/-265) 70ns (-202)	3C 41 46	3C 41 46
42	Minimum Auto Refresh to Active/Auto Refresh Command Period, (^t RFC)	72ns (-335) 75ns (-262/-26A/-265) 80ns (-202)	48 4B 50	48 4B 50
43	SDRAM Device Max Cycle Time (^t CK _{MAX})	12ns (-335) 13ns (-262/-26A/-265/-202)	30 34	30 34
44	SDRAM Device Max DQS-DQ Skew Time (^t DQSQ)	0.40ns (-335) 0.5ns (-262/-26A/-265) 0.6ns (-202)	28 32 3C	28 32 3C
45	SDRAM Device Max Read Data Hold Skew Factor (^t QHS)	0.5ns (-335) 0.75ns (-26A/-265) 1.0ns (-202)	50 75 A0	50 75 A0
46	Reserved		00	00
47	DIMM Height		01	01
48-61	Reserved		00	00
62	SPD Revision	Release 1.0	10	10
63	Checksum for Bytes 0-62	-335 -262 -26A -265 -202	30 BB E8 18 B3	5F FC 29 59 F4
64	Manufacturer's JEDEC ID Code	MICRON	2C	2C
65-71	Manufacturer's JEDEC ID Code (Continued)		00	00
72	Manufacturing Location	01-12	01-0C	01-0D
73-90	Module Part Number (ASCII)		Variable Data	Variable Data
91	PCB Identification Code	1-9	01-09	01-09
92	Identification Code (Continued)	0	00	00
93	Year of Manufacture in BCD		Variable Data	Variable Data

Table 21: Serial Presence-Detect Matrix (Continued)

"1"/"0": Serial Data, "driven to HIGH"/"driven to LOW"; notes appear on page 29

BYTE	DESCRIPTION	ENTRY (VERSION)	MT16VDDF6464H	MT16VDDF12864H
94	Week of Manufacture in BCD		Variable Data	Variable Data
95-98	Module Serial Number		Variable Data	Variable Data
99-127	Manufacturer-Specific Data (RSVD)		–	–

NOTE:

1. Device latencies used for SPD values.
2. The value of t_{RAS} used for -262/-26A/-265 modules is calculated from $t_{RC} - t_{RP}$. Actual device spec value is 40 ns.
3. The JEDEC SPD specification allows fast or slow slew rate values for these bytes. The worst-case (slow slew rate) value is represented here. Systems requiring the fast slew rate setup and hold values are supported, provided the faster minimum slew rate is met.

Figure 15: 200-PIN SODIMM Dimensions – 512MB

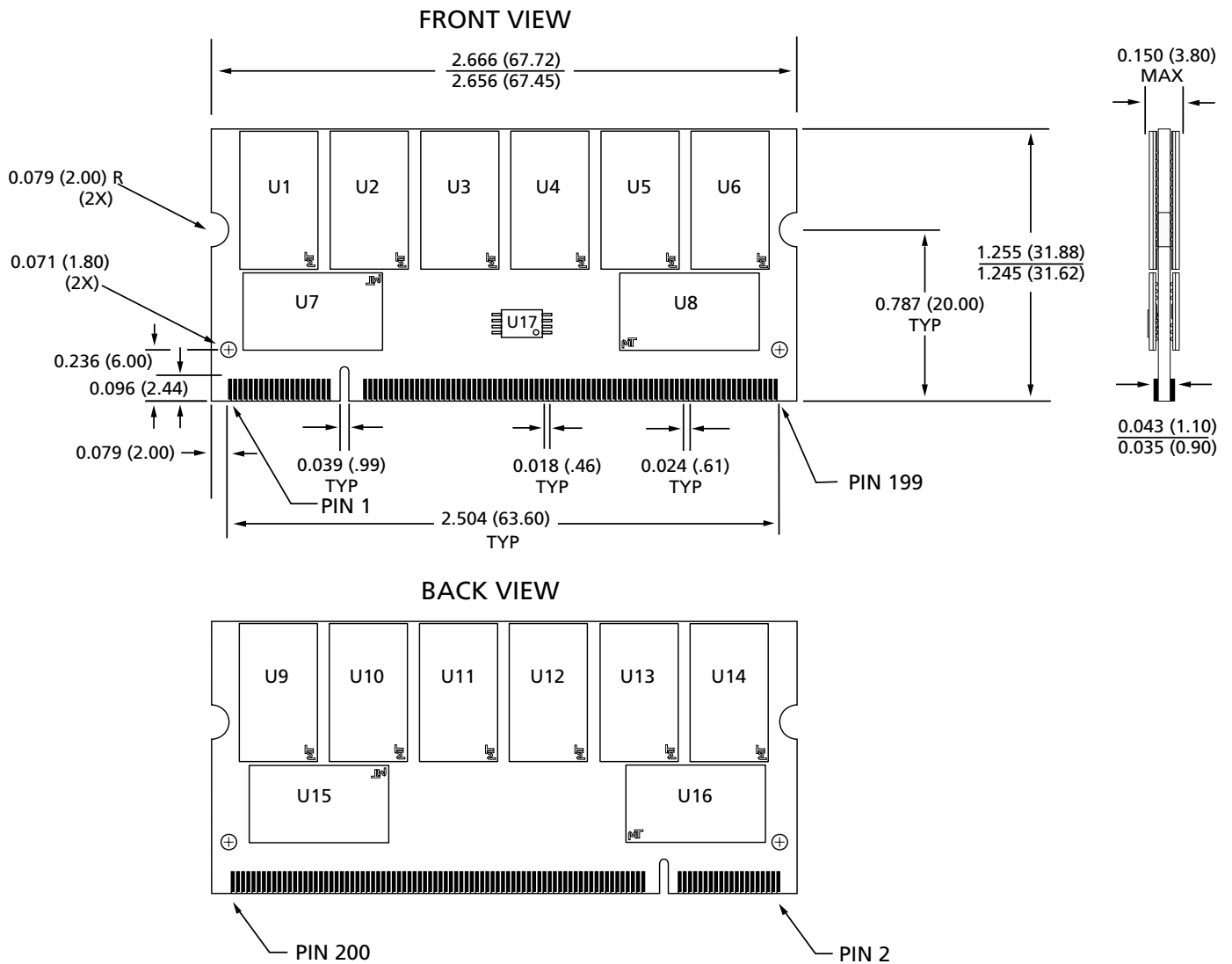

NOTE:

All dimensions are in inches (millimeters) $\frac{\text{MAX}}{\text{MIN}}$ or typical where noted.

Figure 16: 200-PIN SODIMM Dimensions – 1GB

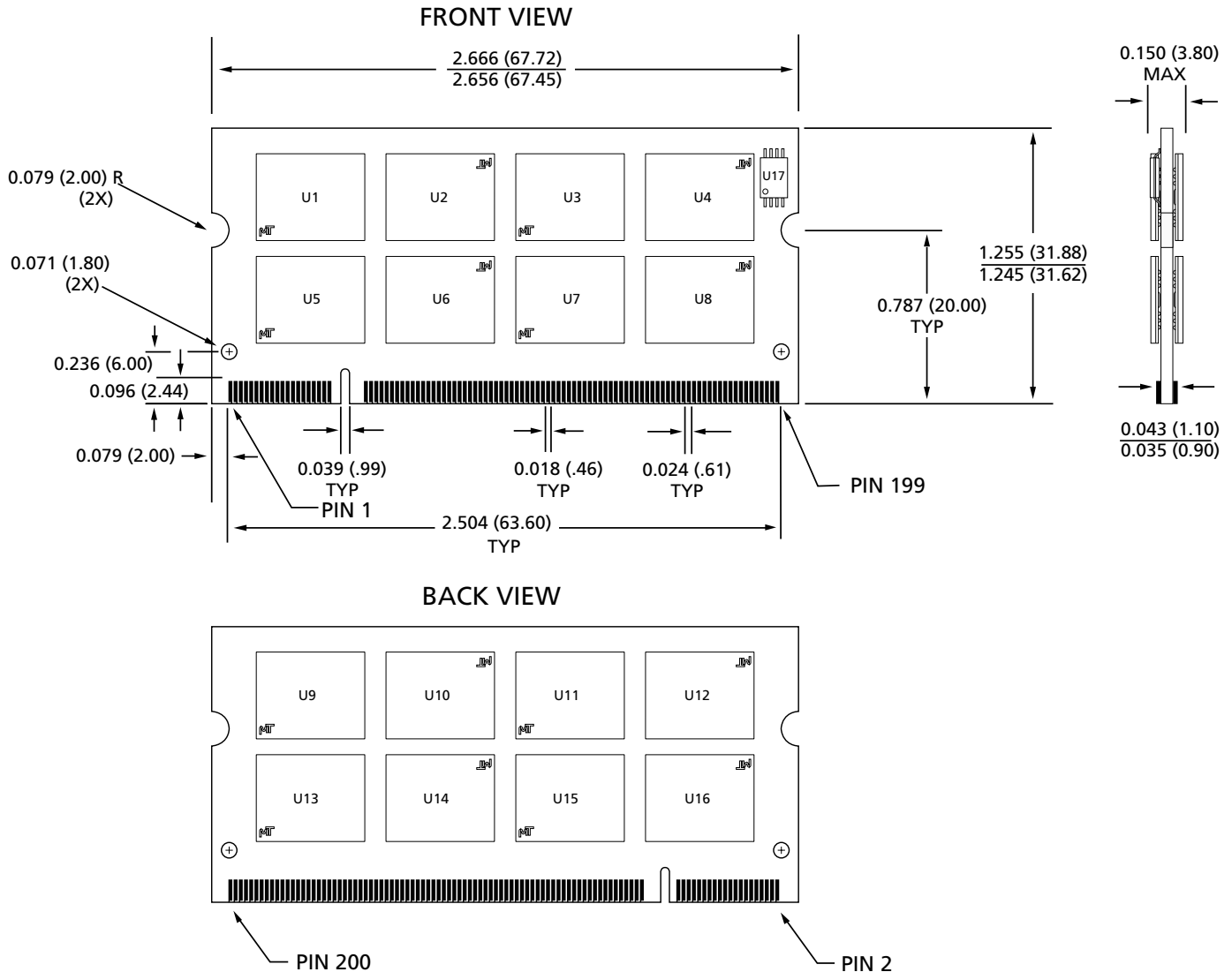

NOTE:

All dimensions are in inches (millimeters) $\frac{\text{MAX}}{\text{MIN}}$ or typical where noted.

Data Sheet Designation

Released (No Mark): This data sheet contains minimum and maximum limits specified over the complete power supply and temperature range for production

devices. Although considered final, these specifications are subject to change, as further product development and data characterization sometimes occur.



8000 S. Federal Way, P.O. Box 6, Boise, ID 83707-0006, Tel: 208-368-3900

E-mail: prodmktg@micron.com, Internet: <http://www.micron.com>, Customer Comment Line: 800-932-4992

Micron, the M logo, and the Micron logo are trademarks and/or service marks of Micron Technology, Inc.

All other trademarks are the property of their respective owners.