

PLEASE CHECK WWW.MOLEX.COM FOR LATEST PART INFORMATION

Part Number: [63883-0600](#)
Status: **Active**
Description: Mini-Mac™ Applicator

Documents:
[RoHS Certificate of Compliance \(PDF\)](#)

General

Product Family	Application Tooling
Series	T9999
Function	Crimp
Geographic Area	Global
Level of Automation	Automatic, Semi-Automatic
More Detailed Tech Information	applicationtooling@molex.com
Product Name	Mini-Mac™
Survey	www.molex.com//review/apptool_survey.html
Tool Type	Mini-Mac Applicator
UPC	822348744275

Physical

Net Weight 4846.612/g

Material Info

Reference - Drawing Numbers

Application Tooling Documents

ATS-638830600, TM-638800000, TM-638800000SP, TM-640160065, TM-640160065CN, TM-640160065DE, TM-640160065FR, TM-640160065IT, TM-640160065JP, TM-640160065KR, TM-640160065MY, TM-640160065PL, TM-640160065RU, TM-640160065SK, TM-640160065SP, TM-640160065TH, TM-640160065TW, TM-640160065VN

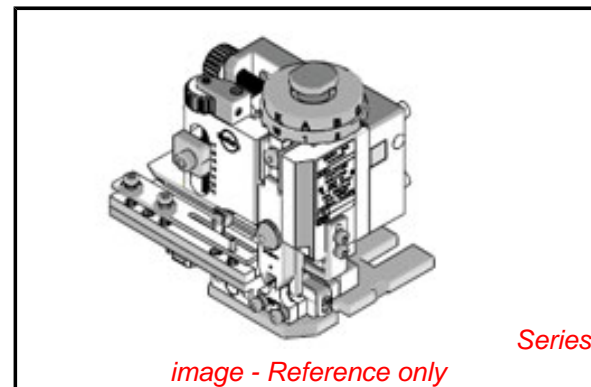

EU RoHS

ELV and RoHS Compliant

REACH SVHC

Not Reviewed

Low-Halogen Status

Not Reviewed

China RoHS



Need more information on product environmental compliance?

Email productcompliance@molex.com
 For a multiple part number RoHS Certificate of Compliance, [click here](#)

Please visit the [Contact Us](#) section for any non-product compliance questions.

Search Parts in this Series

T9999Series

Use With

Molex TM-3000™: 63801-7200 , 63801-7300 , Molex TM-4000™: 63801-7600 , Molex TM-2000™: 63800-8300 , 63800-8400 , and Most Industry Standard Presses or Wire Process Machines