

## High-density Signal Conditioners 10-RACK

### PULSE ISOLATOR

#### Functions & Features

- Galvanically isolating pulse rate signals
- Input frequency = output frequency
- Various outputs (relay, open collector and voltage pulses)
- Optional second channel output available at the front terminals and at the Standard Rack connector

#### Typical Applications

- Isolating field pulse signals in order to reduce noises
- Changing e.g. dry contact signal to e.g. 5 V signals

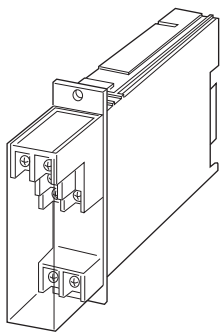

### MODEL: 10PP-[1][2][3]-R[4]

#### ORDERING INFORMATION

- Code number: 10PP-[1][2][3]-R[4]
- Specify a code from below for each of [1] through [4].  
(e.g. 10PP-332-R/Q)
- Frequency range (e.g. 0 - 1000 Hz)
  - Specify the specification for option code /Q  
(e.g. /C01)
- Note: Output 1 and 2 frequency is equal.

#### [1] INPUT

- 1: Mechanical contact (max. 30 Hz)
- 2: Open collector (max. 10 kHz)
- 3: Voltage pulse (max. 10 kHz)

#### [2] OUTPUT 1

- 1: Low frequency open collector (max. 30 Hz)
- 2: High frequency open collector (max. 10 kHz)
- 3: 5 V pulse (max. 10 kHz)
- 4: 12 V pulse (max. 10 kHz)
- 5: 24 V pulse (max. 10 kHz)
- 8: Photo MOSFET relay pulse (max. 30 Hz)

#### [3] OUTPUT 2

- 0: None
- 2: Open collector (max. 10 kHz)

#### POWER INPUT

- DC Power**  
R: 24 V DC  
(Operational voltage range 24 V  $\pm$ 10 %, ripple 10 %p-p max.)

#### [4] OPTIONS

- blank: none  
/Q: With options (specify the specification)

#### SPECIFICATIONS OF OPTION: Q

##### COATING (For the detail, refer to M-System's web site.)

- /C01: Silicone coating
- /C02: Polyurethane coating
- /C03: Rubber coating

#### GENERAL SPECIFICATIONS

- Construction:** Rack-mounted; terminal access via screw terminals at the front and via card-edge connector at the rear; terminal cover provided
- Connection:** M3.5 screw terminals (torque 0.8 N·m) and card-edge connector
- Power input:** Supplied from card-edge connector
- Screw terminal:** Nickel-plated steel
- Housing material:** Flame-resistant resin (black)
- Isolation:** Input to output 1 to output 2 to power
- Frequency range:** Input and output are the same.
- Chattering protection:** Filter provided for mechanical contact input

#### INPUT SPECIFICATIONS

- Excitation:** 12V DC  $\pm$ 2 V @ 30 mA; shortcircuit protection
- **Open Collector**  
**Maximum frequency:** 10 kHz  
**Pulse width time requirement:** 10  $\mu$ sec. min. for ON and OFF  
**Sensing:** Approx. 12 V DC @ 3 mA  
**ON/OFF level:**  $\leq$  200  $\Omega$  / 3.5 V for ON,  $\geq$  100 k $\Omega$  / 7 V for OFF
- **Mechanical Contact**  
**Maximum frequency:** 30 Hz  
**Pulse width time requirement:** 10 msec. min. for ON and OFF  
**Sensing:** Approx. 12 V DC @ 3 mA  
**ON/OFF level:**  $\leq$  200  $\Omega$  / 3.5 V for ON,  $\geq$  100 k $\Omega$  / 7 V for OFF
- **Voltage Pulse**  
**Maximum frequency:** 10 kHz  
**Pulse width time requirement:** 10  $\mu$ sec. min. for high and low levels

**Waveforms:** Square or sine  
**Hi/Lo level:** 2 - 50 V for high level;  $\leq 1$  V for low level  
**Input impedance:** 10 k $\Omega$  min.

## OUTPUT SPECIFICATIONS

### ■ Low Frequency Open Collector (Output 1)

50 V DC @ 100 mA (resistive load)  
**Maximum frequency:** 30 Hz  
**Timer:** Limits ON time within 75  $\pm$ 25 msec. for wider than 75 msec. pulses  
**Saturation voltage:** 0.5 V DC

### ■ High Frequency Open Collector (Output 1)

50 V DC @ 100 mA (resistive load)  
**Maximum frequency:** 10 kHz  
**Saturation voltage:** 0.5 V DC

### ■ Open Collector (Output 2)

40 V DC @ 100 mA (resistive load)  
**Maximum frequency:** 10 kHz  
**Timer:** Limits ON time within 75  $\pm$ 25 msec. for wider than 75 msec. pulses (Timer is provided when output 1 is low frequency open collector or photo MOSFET relay pulse.)  
**Saturation voltage:** 0.5 V DC

### ■ Voltage Pulse

**Maximum frequency:** 10 kHz  
**High level:** Rating (5, 12 or 24 V)  $\pm 10$  %  
**Low level:**  $\leq 0.5$ V  
**Load resistance:**  
 $\geq 250 \Omega$  for 5 V  
 $\geq 600 \Omega$  for 12 V  
 $\geq 1200 \Omega$  for 24 V

### ■ Photo MOSFET Relay Pulse

**Maximum frequency:** 30 Hz  
**Timer:** Limits ON time within 75  $\pm$ 25 msec. for wider than 75 msec. pulses  
**Rating:** 132 V AC @ 200 mA ( $\cos \phi = 1$ )  
30 V DC @ 200 mA (resistive load)  
**ON resistance:**  $\leq 2 \Omega$

## INSTALLATION













**Current consumption:** Approx. 80 mA  
**Operating temperature:** -5 to +55°C (23 to 131°F)  
**Operating humidity:** 30 to 90 %RH (non-condensing)  
**Mounting:** Standard Rack 10BXx  
**Weight:** 200 g (0.44 lb)

## PERFORMANCE

**Insulation resistance:**  $\geq 100$  M $\Omega$  with 500 V DC  
**Dielectric strength:** 500 V AC @ 1 minute  
(input to output 1 to output 2 to power)  
1500 V AC @ 1 minute (input or output or power to ground)

## OUTPUT LOGIC

Applicable for both Output 1 and 2.

INPUT TYPE	INPUT	VOLTAGE PULSE OUTPUT	OPEN COLLECTOR or PHOTO MOSFET RELAY PULSE OUTPUT
Voltage Pulse	H  L 	H  L 	OFF  ON 
Mechanical Contact Open Collector	OFF  ON 	H  L 	OFF  ON 

## EXTERNAL DIMENSIONS & TERMINAL ASSIGNMENTS unit: mm (inch)

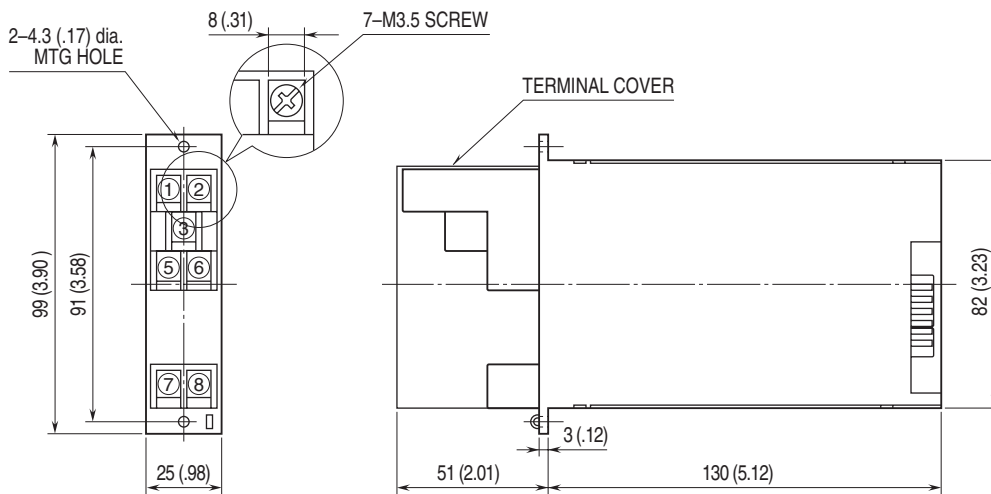

## SCHEMATIC CIRCUITRY & CONNECTION DIAGRAM

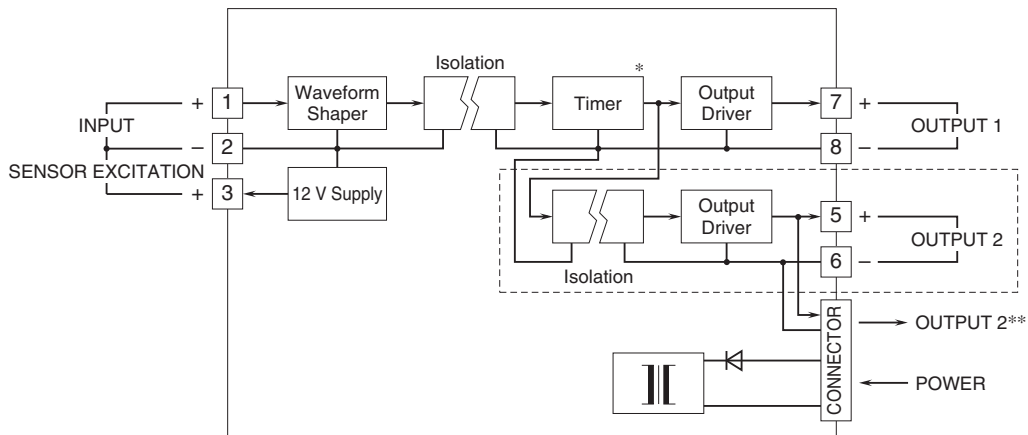

\* Timer is provided for low frequency open collector or photo MOSFET relay pulse output.

\*\* For 1 output channel type, OUTPUT 1 is also connected to the card-edge connector inside.

Note: The section enclosed by broken line is only for 2nd output channel.

### Input Connection Examples

#### ■ Mechanical Contact or Open Collector

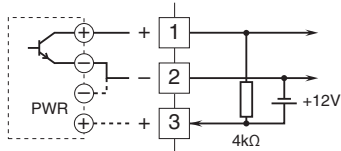

#### ■ Voltage Pulse

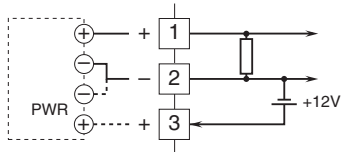

### Output Connection Examples

#### ■ Open Collector

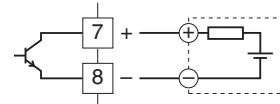

#### ■ Voltage Pulse

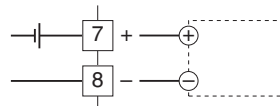

#### ■ Photo MOSFET Relay Pulse

##### • AC Powered

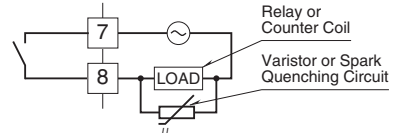

##### • DC Powered

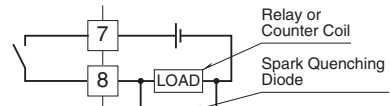

Specifications are subject to change without notice.