

T1G6001528-Q3

DC – 6 GHz 18 W GaN RF Power Transistor

Applications

- General Purpose RF Power
- Jammers
- Military and Civilian Radar
- Professional and Military radio systems
- Wideband amplifiers
- Test instrumentation
- Avionics



Product Features

- Frequency: DC to 6 GHz
- Output Power (P3dB): 18 W at 6 GHz
- Linear Gain: >10 dB at 6 GHz
- Operating Voltage: 28 V
- Low thermal resistance package

Functional Block Diagram

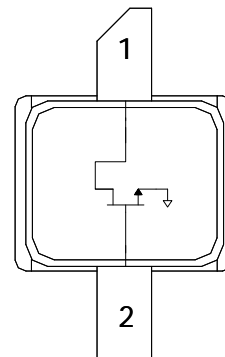

General Description

The TriQuint T1G6001528-Q3 is a 18 W (P3dB) discrete GaN on SiC HEMT which operates from DC to 6 GHz and typically provides >10 dB gain at 6 GHz. The device is constructed with TriQuint's proven 0.25 μm process, which features advanced field plate techniques to optimize power and efficiency at high drain bias operating conditions. This optimization can potentially lower system costs in terms of fewer amplifier line-ups and lower thermal management costs.

Lead-free and RoHS compliant

Evaluation Boards are available upon request.

Pin Configuration

Pin #	Symbol
1	Vd/RF OUT
2	Vg/RF IN
Flange	Source

Ordering Information

Part No.	ECCN	Description
T1G6001528-Q3	EAR99	Packaged Transistor
T1G6001528-Q3 EVB1	EAR99	5-6 GHz Eval Board

T1G6001528-Q3

DC – 6 GHz 18 W GaN RF Power Transistor



Specifications

Absolute Maximum Ratings

Parameter	Rating
Drain Voltage, Vd	+40 V
Gate Voltage, Vg	-50 to 0 V
Drain to Gate Voltage, Vd – Vg	80 V
Drain Current, Id	1.5 A
Gate Current, Ig	-25 to 25 mA
Power Dissipation, P _{diss}	26 W
RF Input Power, CW, T = 25°C	37 dBm
Channel Temperature, T _{ch}	250 °C
Mounting Temperature (30 Seconds)	260 °C
Storage Temperature	-40 to 150 °C

Absolute maximum ratings at 3 GHz.

Operation of this device outside the parameter ranges given above may cause permanent damage. These are stress ratings only, and functional operation of the device at these conditions is not implied.

Recommended Operating Conditions

Parameter	Min	Typical	Max	Units
Vd		28	30	V
Idq		50		mA
Id_drive (Under RF Drive)		1400		mA
Vg		-3.7		V
Channel Temperature, T _{ch}			200	°C

Electrical specifications are measured at specified test conditions. Specifications are not guaranteed over all recommended operating conditions.

Electrical Specifications

Test conditions unless otherwise noted: 25 °C, Vd = 28 V, Idq = 50 mA, Vg = -3.7 V Typical.

RF Characteristics	Symbol	Min	Typ	Max	Units
Load Pull Performance at 3 GHz (V _{DS} =28V, I _{DQ} = 50mA, CW)					
Linear Gain	G _{LIN}		15.0		dB
Output Power at 3 dB Gain Compression	P _{3dB}		20.0		W
Drain Efficiency at 3 dB Gain Compression	DE _{3dB}		60		%
Power-Added Efficiency at 3 dB Gain Compression	PAE _{3dB}		56		%
Gain at 3 dB Compression	G _{3dB}		12.5		dB
Load Pull Performance at 6 GHz (V _{DS} =28V, I _{DQ} = 50mA, CW)					
Linear Gain	G _{LIN}		11.5		dB
Output Power at 3 dB Gain Compression	P _{3dB}		19.0		W
Drain Efficiency at 3 dB Gain Compression	DE _{3dB}		60		%
Power-Added Efficiency at 3 dB Gain Compression	PAE _{3dB}		52		%
Gain at 3 dB Compression	G _{3dB}		8.5		dB
Performance at 5.4 GHz in the 5-6 GHz Fixture (V _{DS} =28V, I _{DQ} = 50mA, Pulse: 100µs 20%)					
Linear Gain	G _{LIN}	9.0	9.5		dB
Output Power at 3 dB Gain Compression	P _{3dB}	17.8	21.0		W
Drain Efficiency at 3 dB Gain Compression	DE _{3dB}	50	58		%
Power-Added Efficiency at 3 dB Gain Compression	PAE _{3dB}	40	45		%
Gain at 3 dB Compression	G _{3dB}	6.0	6.5		dB
Narrowband Performance at 3.5 GHz (V _{DS} =28V, I _{DQ} = 50mA, CW at P1dB, applied for 3.5 secs)					
Impedance Mismatch Ruggedness	VSWR			10:1	

Note: VSWR testing performed with increasing real impedance value only from reference Z to 10 times reference Z.

T1G6001528-Q3

DC – 6 GHz 18 W GaN RF Power Transistor



Specifications (cont.)

Thermal and Reliability Information

Parameter	Condition	Rating
Thermal Resistance, θ_{JC} , measured to back of package	Tbase = 85 °C	$\theta_{JC} = 5.0$ °C/W
Channel Temperature (Tch), and Median Lifetime (Tm)	Tbase = 85 °C, Vd = 28 V, Idq = 50 mA, Pdiss = 1.4 W	Tch = 92 °C Tm = 2.4 E+10 Hours
Channel Temperature (Tch), and Median Lifetime (Tm) Under RF Drive	Tbase = 85 °C, Vd = 28 V, Id = 1400 mA, Pout = 43.5 dBm, Pdiss = 21.8 W	Tch = 195 °C Tm = 2.2 E+6 Hours

Median Lifetime (Tm) vs. Channel Temperature (Tch)

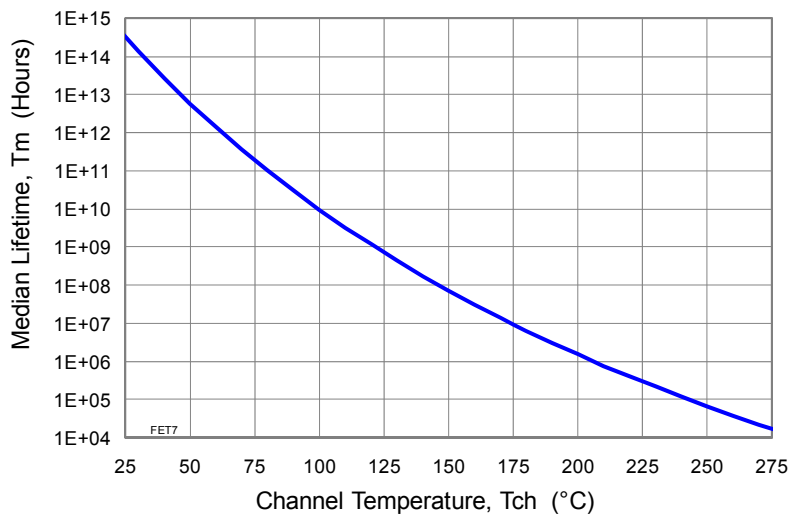

Max Channel Temperature
Tbase = 85 °C, Pdiss = 3 w/mm

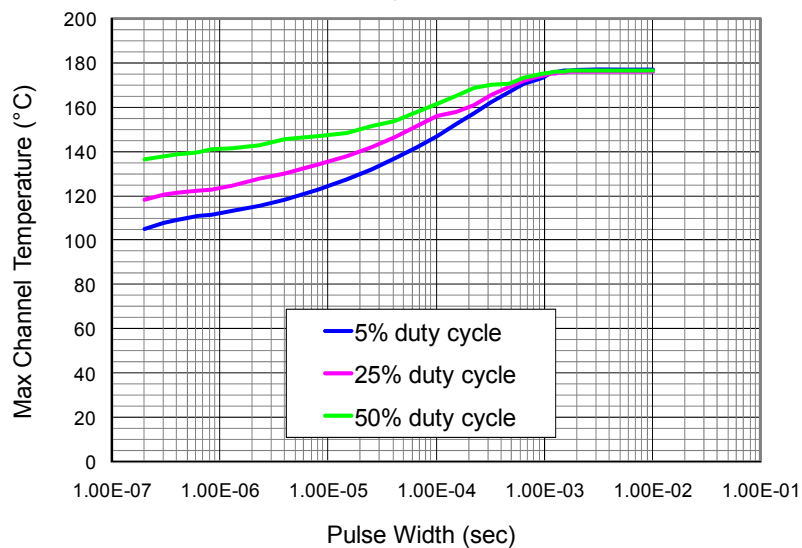

T1G6001528-Q3

DC – 6 GHz 18 W GaN RF Power Transistor



Load Pull Smith Chart

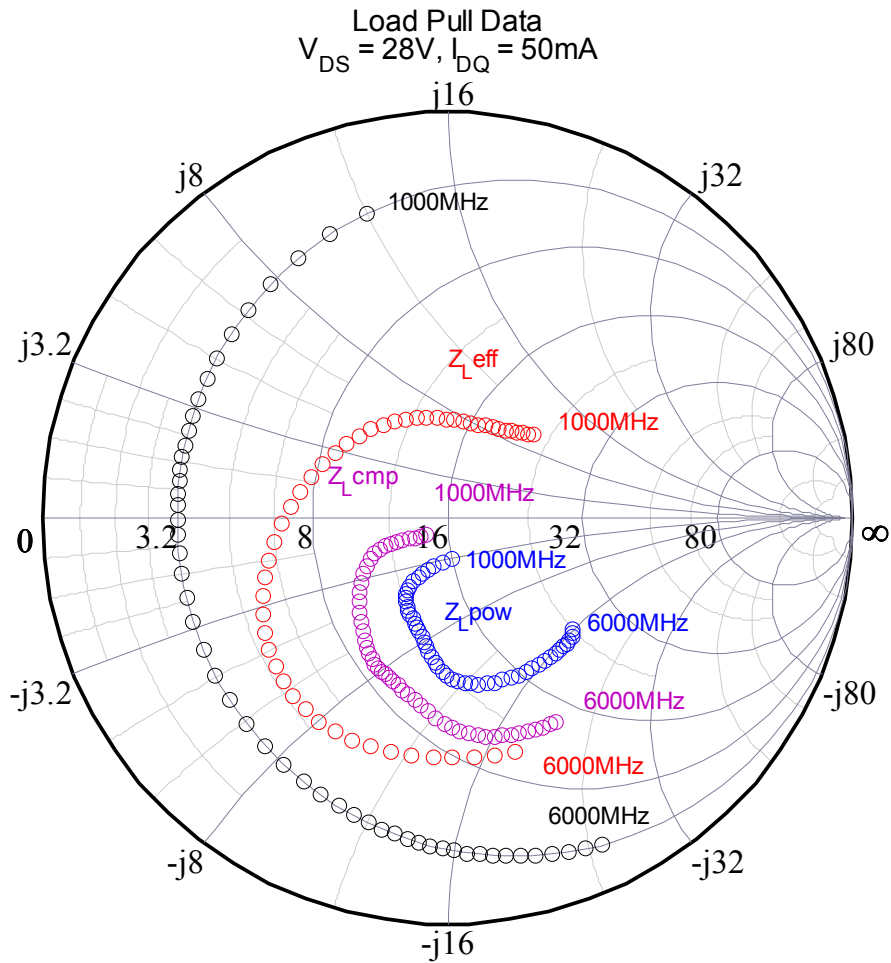

T1G6001528-Q3

DC – 6 GHz 18 W GaN RF Power Transistor



Load Pull Data

RF performance that the device typically exhibits when placed in the specified impedance environment. The impedances are not the impedances of the device, they are the impedances presented to the device via an RF circuit or load-pull system. The impedances listed follow an optimized trajectory to maintain high power and high efficiency (ZLcmp).

Test conditions: $V_{DS}=28V$, $I_{DQ}=50mA$

Freq. [MHz]	Real(ZS)	Imag(ZS)	Real(ZL)	Imag(ZL)	G3dB [dB]	P3dB [dBm]	P3dB [W]	PAE @3dB[%]
1000	3.20	12.00	14.30	-1.20	19.5	42.5	17.8	55.4
1100	3.20	10.38	13.92	-1.26	19.2	42.6	18.0	55.8
1200	3.20	8.95	13.53	-1.31	18.9	42.6	18.2	56.1
1300	3.20	7.70	13.15	-1.37	18.5	42.7	18.5	56.2
1400	3.20	6.60	12.77	-1.42	18.2	42.7	18.7	56.3
1500	3.20	5.65	12.39	-1.48	17.9	42.8	18.9	56.3
1600	3.20	4.82	12.00	-1.53	17.6	42.8	19.1	56.2
1700	3.20	4.11	11.62	-1.59	17.3	42.9	19.3	56.1
1800	3.20	3.49	11.24	-1.64	16.9	42.9	19.6	55.9
1900	3.20	2.96	10.85	-1.70	16.6	43.0	19.8	55.6
2000	3.20	2.50	10.47	-1.75	16.3	43.0	20.0	55.4
2100	3.20	2.09	10.29	-2.27	15.9	43.0	20.1	55.2
2200	3.20	1.72	10.10	-2.79	15.5	43.0	20.2	54.9
2300	3.20	1.38	9.92	-3.31	15.2	43.1	20.3	54.7
2400	3.20	1.05	9.73	-3.83	14.8	43.1	20.4	54.5
2500	3.20	0.71	9.55	-4.35	14.4	43.1	20.5	54.3
2600	3.20	0.34	9.37	-4.86	14.0	43.1	20.5	54.2
2700	3.20	-0.05	9.18	-5.38	13.6	43.1	20.6	54.2
2800	3.20	-0.50	9.00	-5.90	13.3	43.2	20.7	54.3
2900	3.20	-1.01	8.81	-6.42	12.9	43.2	20.8	54.4
3000	3.20	-1.60	8.63	-6.94	12.5	43.2	20.9	54.7
3100	3.20	-2.28	8.68	-7.17	12.5	43.2	20.9	55.1
3200	3.20	-3.04	8.74	-7.39	12.4	43.2	21.0	55.6
3300	3.20	-3.86	8.79	-7.62	12.4	43.2	21.0	56.1
3400	3.20	-4.73	8.85	-7.85	12.3	43.2	21.1	56.7
3500	3.20	-5.63	8.90	-8.08	12.3	43.3	21.1	57.3
3600	3.20	-6.54	8.95	-8.30	12.2	43.3	21.1	57.9
3700	3.20	-7.45	9.01	-8.53	12.2	43.3	21.2	58.6
3800	3.20	-8.34	9.06	-8.76	12.1	43.3	21.2	59.1
3900	3.20	-9.20	9.12	-8.98	12.1	43.3	21.3	59.6
4000	3.20	-10.00	9.17	-9.21	12.0	43.3	21.3	60.0
4100	3.20	-10.74	9.20	-9.79	11.8	43.3	21.3	60.3
4200	3.20	-11.43	9.22	-10.38	11.6	43.3	21.2	60.5
4300	3.20	-12.06	9.25	-10.96	11.3	43.3	21.2	60.5
4400	3.20	-12.66	9.27	-11.54	11.1	43.3	21.1	60.5
4500	3.20	-13.23	9.30	-12.13	10.9	43.3	21.1	60.3
4600	3.20	-13.78	9.32	-12.71	10.7	43.2	21.1	60.1
4700	3.20	-14.33	9.35	-13.29	10.5	43.2	21.0	59.7
4800	3.20	-14.87	9.37	-13.87	10.2	43.2	21.0	59.3
4900	3.20	-15.43	9.40	-14.46	10.0	43.2	20.9	58.8
5000	3.20	-16.00	9.42	-15.04	9.8	43.2	20.9	58.2
5100	3.20	-16.60	9.84	-15.58	9.7	43.2	20.8	57.5
5200	3.20	-17.25	10.27	-16.12	9.6	43.2	20.7	56.8
5300	3.20	-17.94	10.69	-16.66	9.5	43.1	20.6	55.9
5400	3.20	-18.70	11.11	-17.20	9.4	43.1	20.5	55.0
5500	3.20	-19.52	11.54	-17.74	9.3	43.1	20.5	54.1
5600	3.20	-20.42	11.96	-18.27	9.1	43.1	20.4	53.0
5700	3.20	-21.41	12.38	-18.81	9.0	43.1	20.3	52.0
5800	3.20	-22.49	12.80	-19.35	8.9	43.0	20.2	50.8
5900	3.20	-23.69	13.23	-19.89	8.8	43.0	20.1	49.6
6000	3.20	-25.00	13.65	-20.43	8.7	43.0	20.0	48.4

T1G6001528-Q3

DC – 6 GHz 18 W GaN RF Power Transistor



Typical Performance

S-Parameter Smith Chart

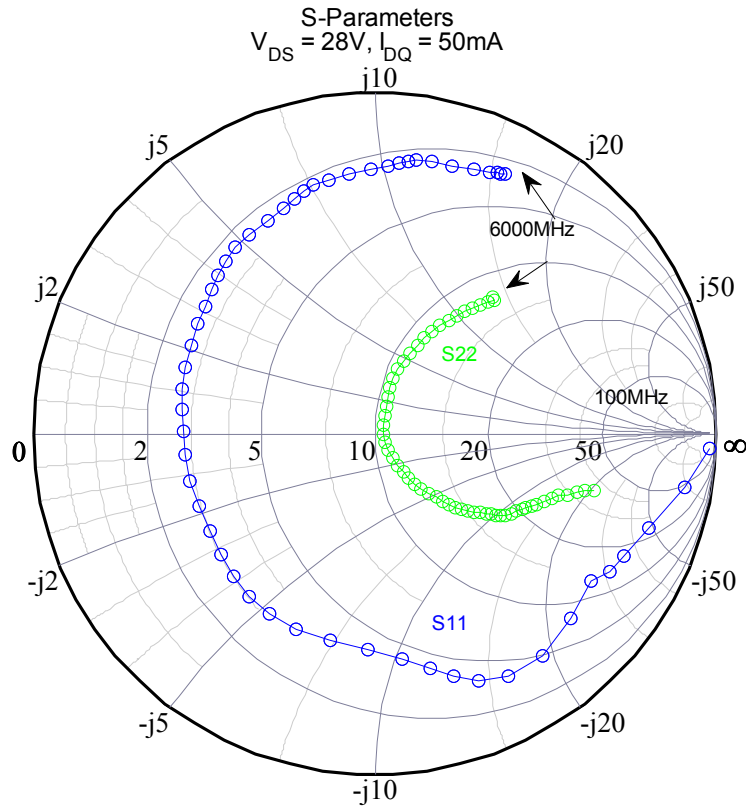

Small Signal Gain

Maximum Stable Gain of T1G6001528 □ Q3

$V_{DS} = 28V, I_{DQ} = 50mA$

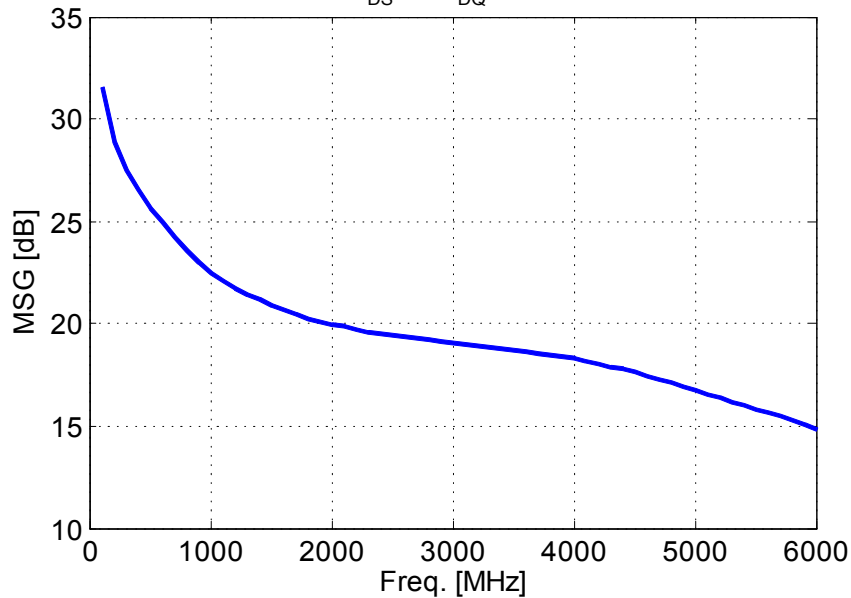

T1G6001528-Q3

DC – 6 GHz 18 W GaN RF Power Transistor



Typical Performance (cont.)

Performance is measured at DUT reference plane

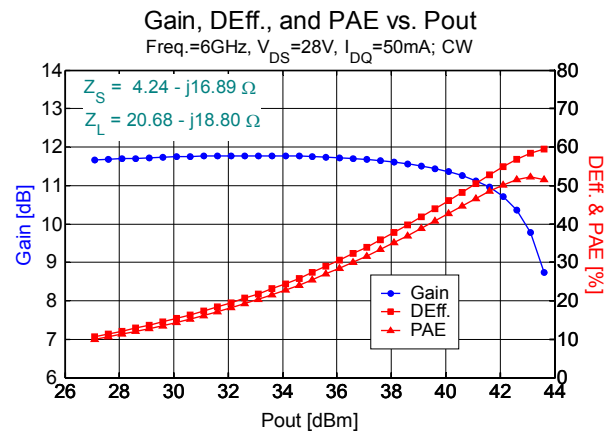
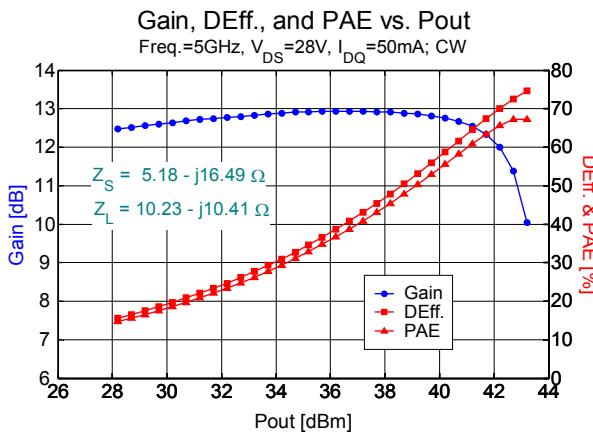
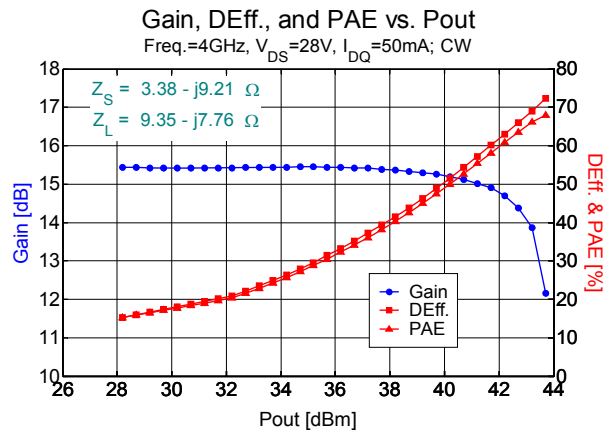
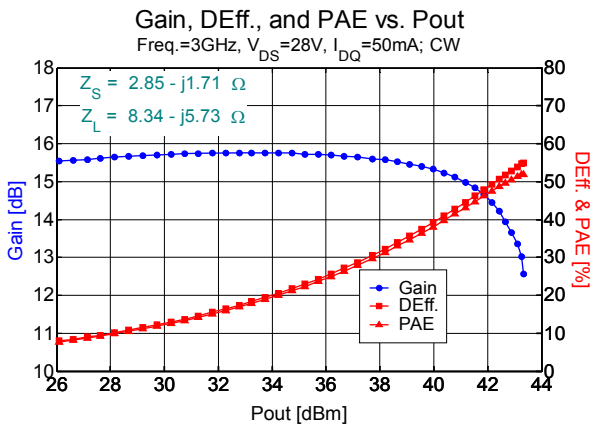
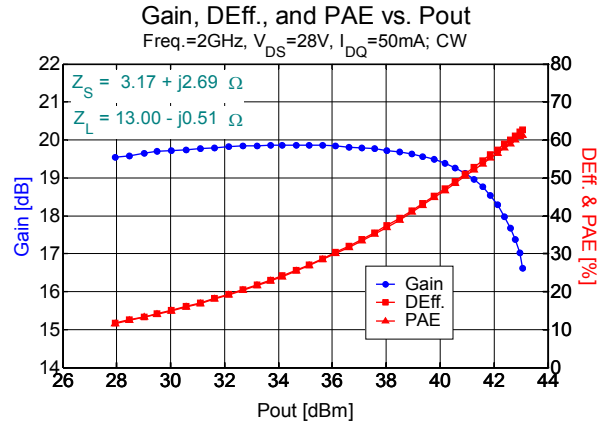
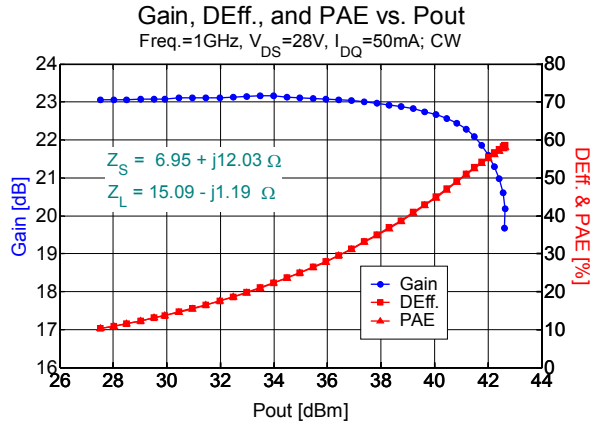

T1G6001528-Q3

DC – 6 GHz 18 W GaN RF Power Transistor



Typical Performance (cont.)

Performance measured in TriQuint’s 5.0 GHz to 6.0 GHz Evaluation Board at 3 dB compression

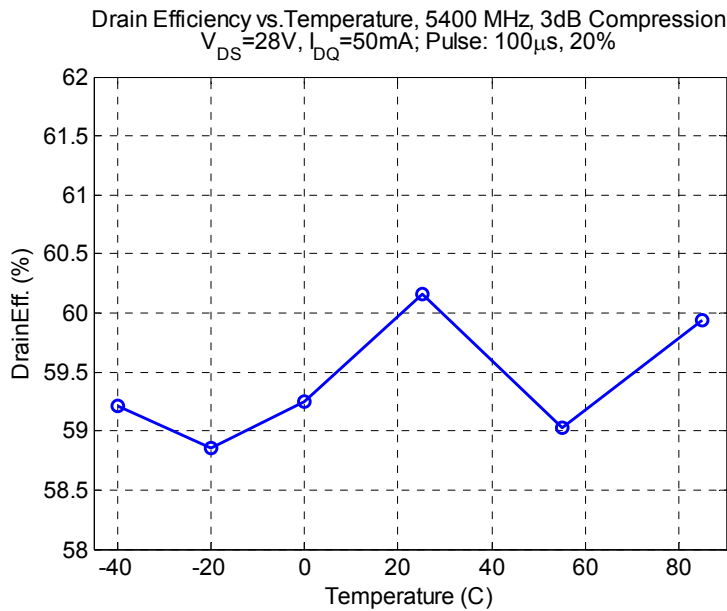
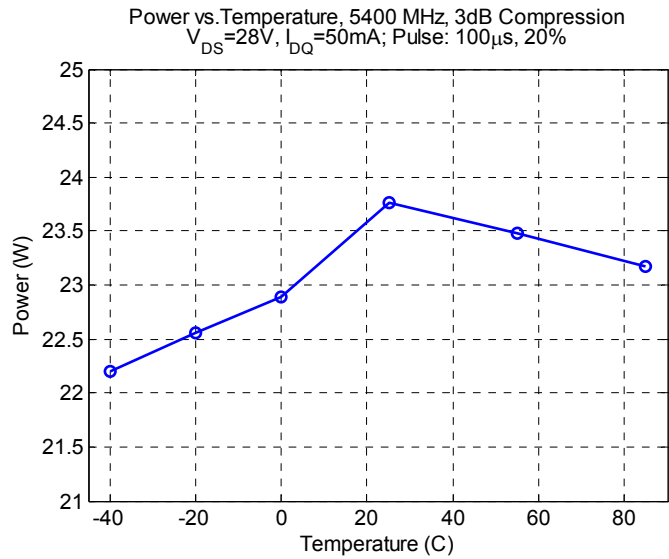
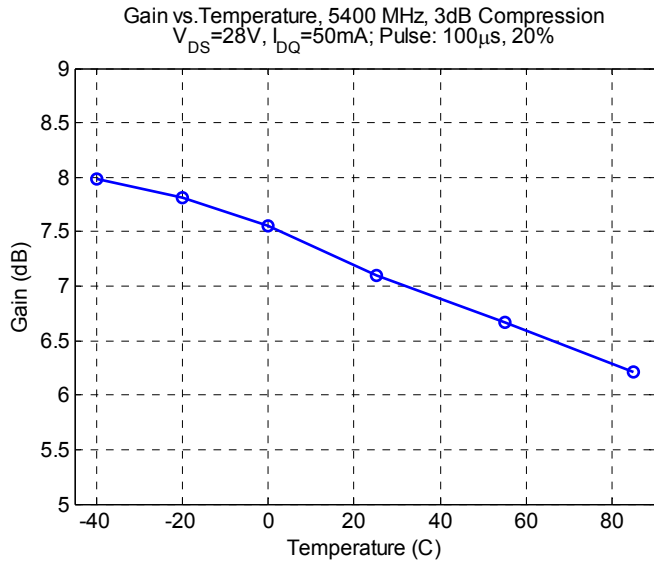

T1G6001528-Q3

DC – 6 GHz 18 W GaN RF Power Transistor



Evaluation Board Performance: 5 to 6 GHz

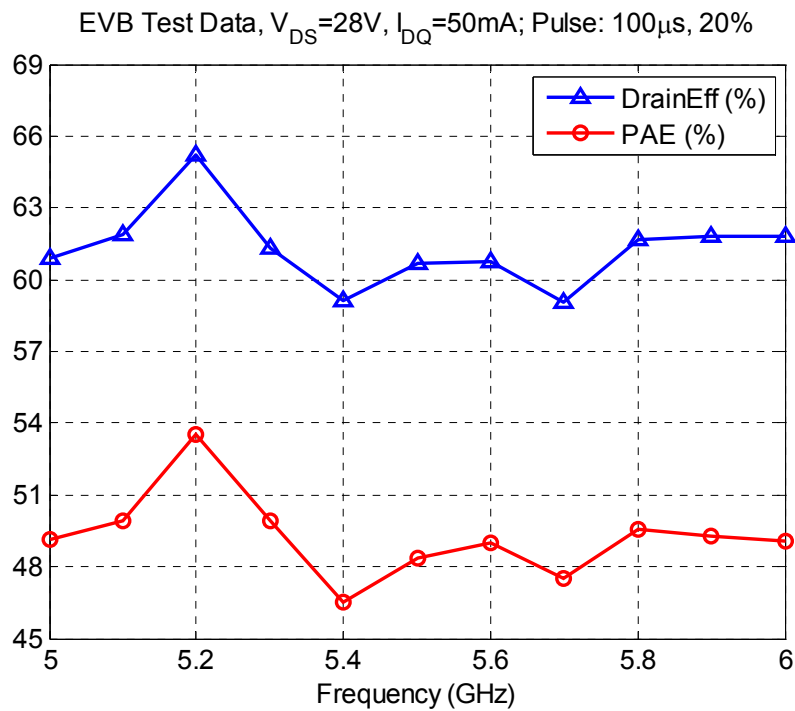
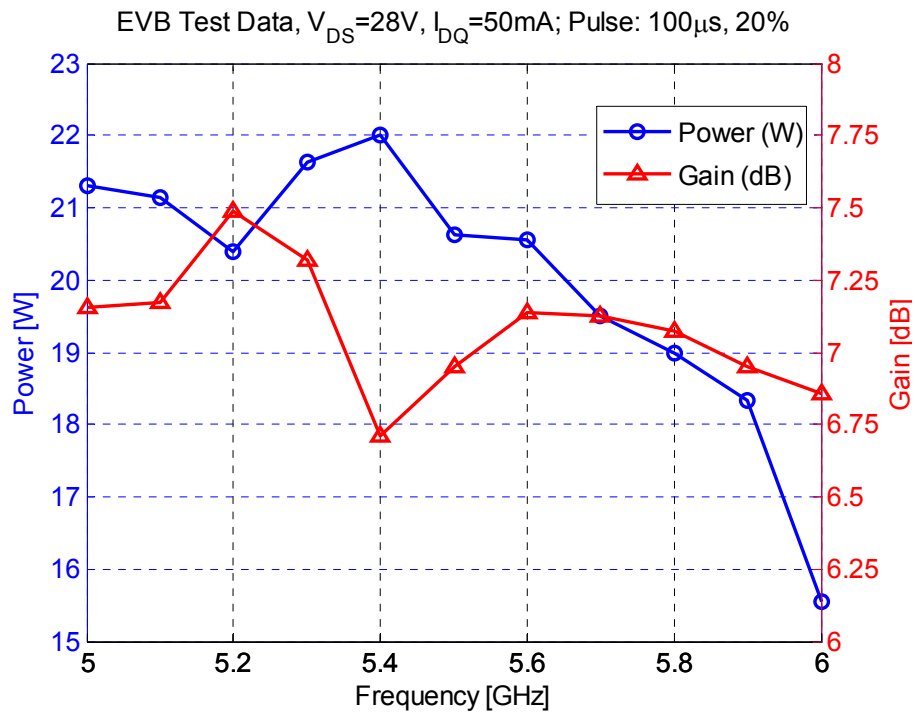

T1G6001528-Q3

DC – 6 GHz 18 W GaN RF Power Transistor

Application Circuit

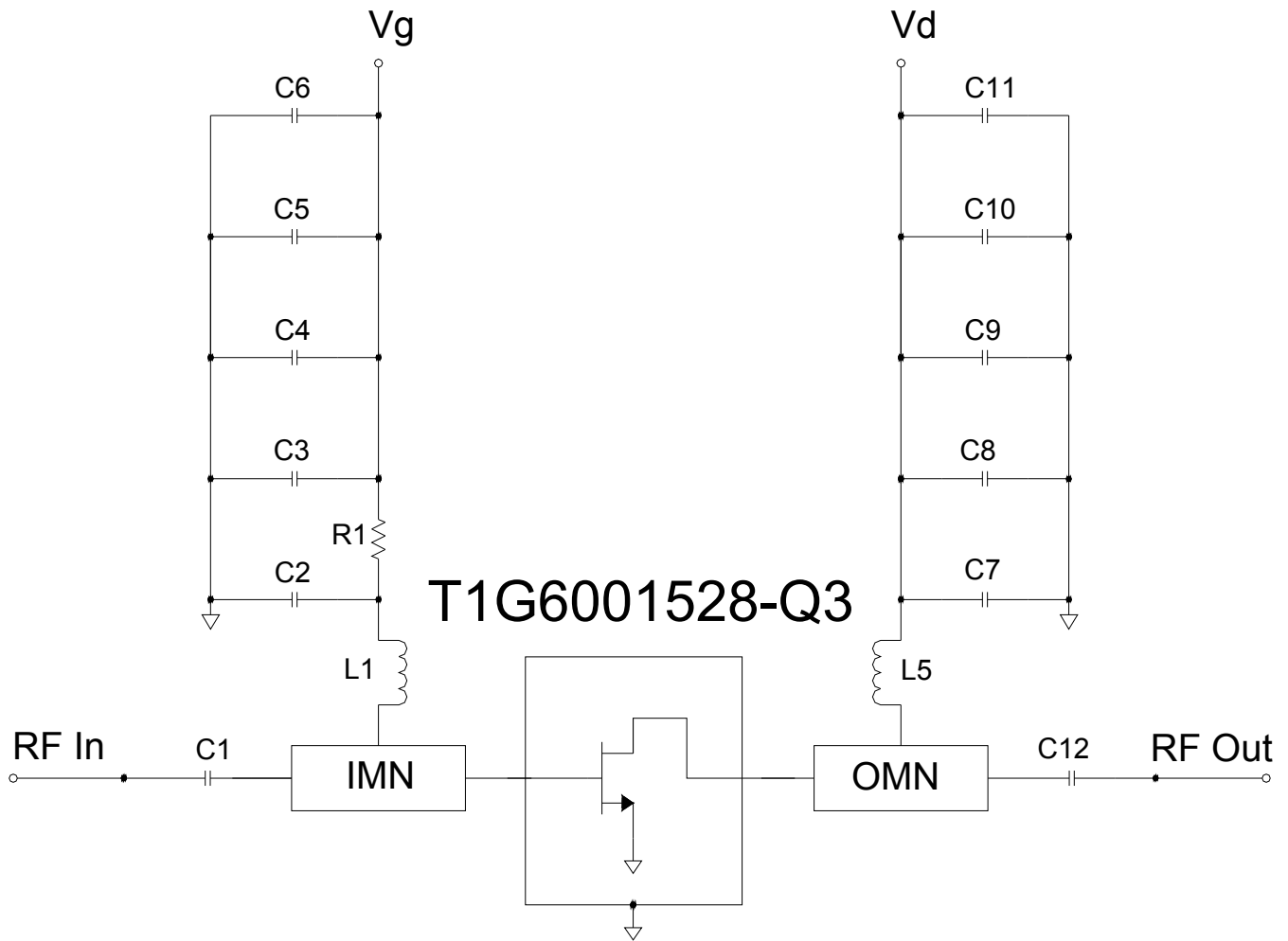

Bias-up Procedure	Bias-down Procedure
Vg set to -5.0V	Turn off RF signal
Vd set to 28 V	Turn off Vd and wait 1 second to allow drain capacitor dissipation
Adjust Vg more positive until quiescent Id is 50 mA. This will be ~ Vg = -3.7 V typical	Turn off Vg
Apply RF signal	

T1G6001528-Q3

DC – 6 GHz 18 W GaN RF Power Transistor

Pin Description

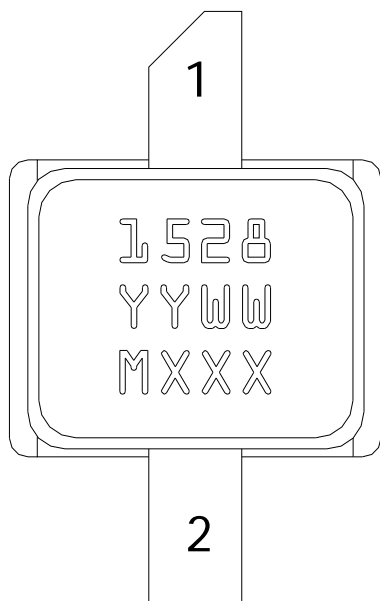

TOP VIEW

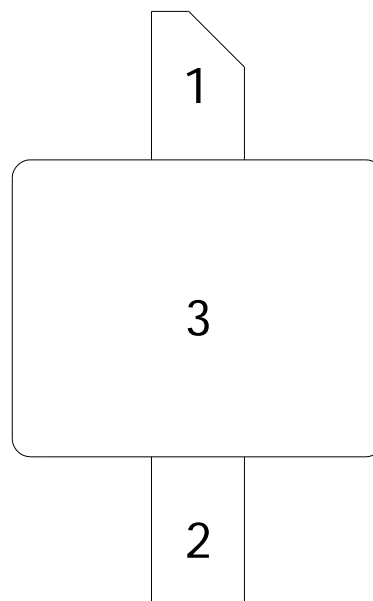

BOTTOM VIEW

Pin	Symbol	Description
1	Vd/ RF OUT	Drain voltage/ RF Output matched to 50 ohms; see Application Circuit on page 9 as an example.
2	Vg/RF IN	Gate voltage/ RF Input matched to 50 ohms; see Application Circuit on page 9 as an example
3	Flange	Source connected to ground; see Application Circuit on page 9 as an example.

The T1G6001528-Q3 will be marked with the “1528” designator and a lot code marked below the part designator. The “YY” represents the last two digits of the year the part was manufactured, the “WW” is the work week, and the “XXXX” is an auto-generated number.

T1G6001528-Q3

DC – 6 GHz 18 W GaN RF Power Transistor

Applications Information

Evaluation Board Layout

Top RF layer is 0.020" thick Rogers RO3203, $\epsilon_r = 3.02$.

The pad pattern shown has been developed and tested for optimized assembly at TriQuint Semiconductor. The PCB land pattern has been developed to accommodate lead and package tolerances. Since surface mount processes vary from company to company, careful process development is recommended.

For further technical information, refer to the [T1G6001528-Q3](#) Product Information page.

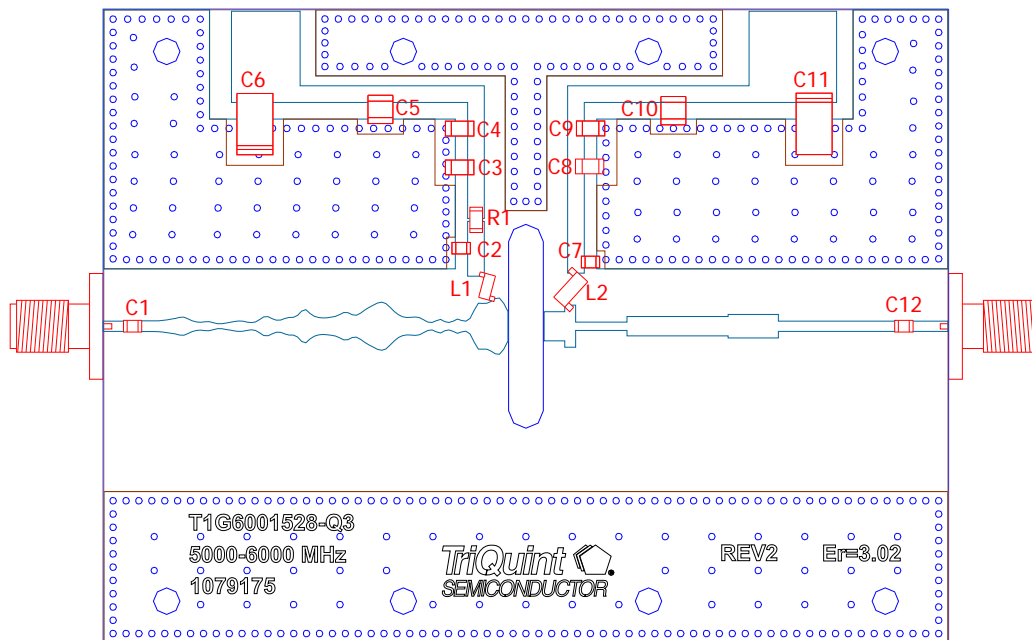

Bill of Material

Ref Des	Value	Description	Manufacturer	Part Number
C1, C7, C12	15 pF	Cap, 0402, 500 V, 5%, P90	ATC	100A150JW500XC
C2	22 pF	Cap, 0603, 500 V, 5%, P90	ATC	100A220JW500XC
C3, C8	0.01 uF	Cap, 1206, 100 V, 10%, X7R	Kemet	C1206C103K1RACTU
C4, C9	0.1 uF	Cap, 1206, 100 V, 10%, X7R	Kemet	C1206C104K1RACTU
C5, C10	1.0 uF	Cap, 1812, 100 V, 10%, X7R	AVX	18121C105KAT2A
C6, C11	22 uF	Cap, D, 35V, 10%, SMD	Kemet	T491D226K035AT
L1	5.4 nH	Ind, 0906, 1.6A, 5%, SMD	CoilCraft	0906-5JL
L2	9.85 nH	Ind, 1606, 1.6A, 5%, SMD	CoilCraft	1606-9JLB
R1	12.1Ohms	Res, 1206, 0.1 W, 5%, SMD	Vishay	CRC120612R1FKEA

T1G6001528-Q3

DC – 6 GHz 18 W GaN RF Power Transistor

Mechanical Information

Package Information and Dimensions

All dimensions are in millimeters.

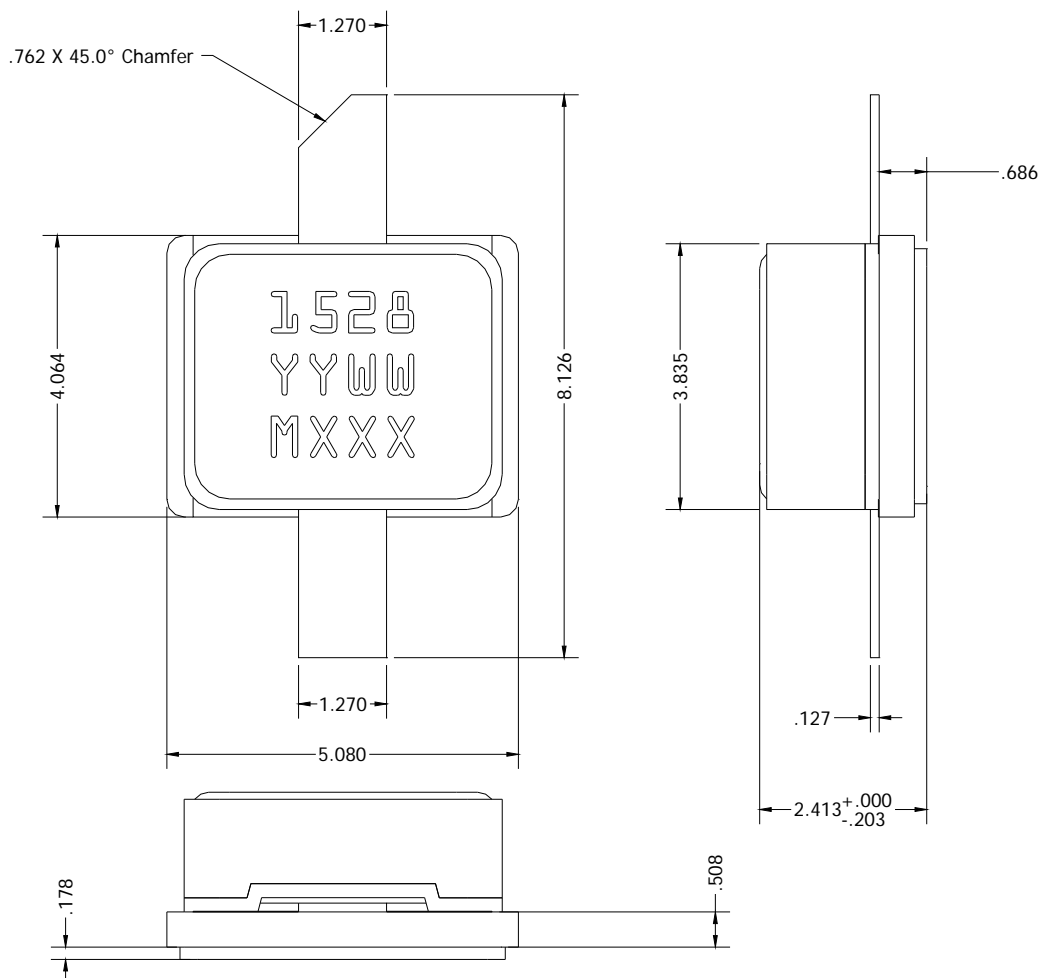

This package is lead-free/RoHS-compliant. The package base is CuMo and the plating material on the leads is NiAu. It is compatible with both lead-free (maximum 260 °C reflow temperature) and tin-lead (maximum 245 °C reflow temperature) soldering processes.

T1G6001528-Q3

DC – 6 GHz 18 W GaN RF Power Transistor

Product Compliance Information

ESD Information



Caution! ESD-Sensitive Device

ESD Rating: Class 1A
Value: ≥ 250 V
Test: Human Body Model (HBM)
Standard: JEDEC Standard JESD22-A114

MSL Rating

Level 3 at +260 °C convection reflow
The part is rated Moisture Sensitivity Level 3 at 260°C per JEDEC standard IPC/JEDEC J-STD-020.

ECCN

US Department of Commerce EAR99

Solderability

Compatible with the latest version of J-STD-020, Lead free solder, 260° C

This part is compliant with EU 2002/95/EC RoHS directive (Restrictions on the Use of Certain Hazardous Substances in Electrical and Electronic Equipment).

This product also has the following attributes:

- Lead Free
- Halogen Free (Chlorine, Bromine)
- Antimony Free
- TBBP-A (C₁₅H₁₂Br₄O₂) Free
- PFOS Free
- SVHC Free

Recommended Soldering Temperature Profile

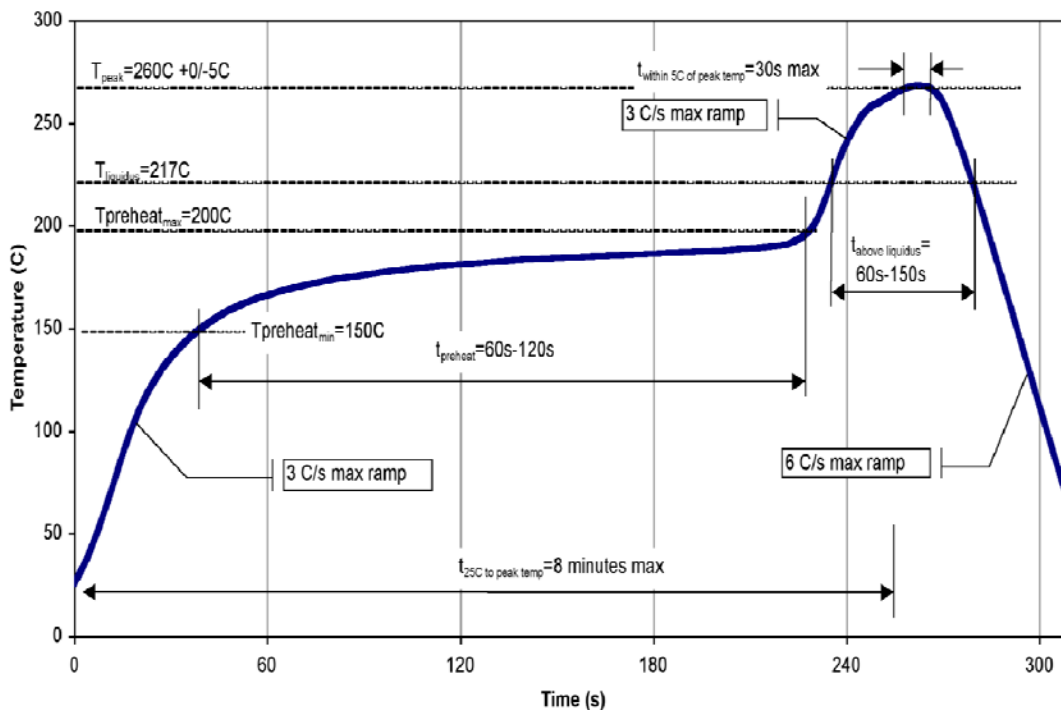

T1G6001528-Q3

DC – 6 GHz 18 W GaN RF Power Transistor



Contact Information

For the latest specifications, additional product information, worldwide sales and distribution locations, and information about TriQuint:

Web: www.triquint.com
Email: info-sales@tqs.com

Tel: +1.972.994.8465
Fax: +1.972.994.8504

For technical questions and application information:

Email: info-products@tqs.com

Important Notice

The information contained herein is believed to be reliable. TriQuint makes no warranties regarding the information contained herein. TriQuint assumes no responsibility or liability whatsoever for any of the information contained herein. TriQuint assumes no responsibility or liability whatsoever for the use of the information contained herein. The information contained herein is provided "AS IS, WHERE IS" and with all faults, and the entire risk associated with such information is entirely with the user. All information contained herein is subject to change without notice. Customers should obtain and verify the latest relevant information before placing orders for TriQuint products. The information contained herein or any use of such information does not grant, explicitly or implicitly, to any party any patent rights, licenses, or any other intellectual property rights, whether with regard to such information itself or anything described by such information.

TriQuint products are not warranted or authorized for use as critical components in medical, life-saving, or life-sustaining applications, or other applications where a failure would reasonably be expected to cause severe personal injury or death.