

Surface Mount Ultrafast Plastic Rectifier



DO-214AB (SMC)

FEATURES

- Oxide planar chip junction
- Ultrafast recovery time
- Low forward voltage, low power losses
- High forward surge capability
- Meets MSL level 1, per J-STD-020, LF maximum peak of 260 °C
- Solder dip 260 °C, 40 s
- Component in accordance to RoHS 2002/95/EC and WEEE 2002/96/EC



RoHS
COMPLIANT

TYPICAL APPLICATIONS

For us in high frequency rectification and freewheeling application in switching mode converters and inverters for consumer, computer, automotive and telecommunication.

MECHANICAL DATA

Case: DO-214AB (SMC)

Epoxy meets UL 94V-0 flammability rating

Terminals: Matte tin plated leads, solderable per J-STD-002 and JESD22-B102

E3 suffix for consumer grade, meets JESD 201 class 1A whisker test

Polarity: Color band denotes cathode end

PRIMARY CHARACTERISTICS	
$I_{F(AV)}$	3.0 A
V_{RRM}	100 V, 150 V, 200 V
I_{FSM}	100 A
t_{tr}	20 ns
V_F at $I_F = 3.0$ A	0.74 V
T_J max.	150 °C

MAXIMUM RATINGS ($T_A = 25$ °C unless otherwise noted)					
PARAMETER	SYMBOL	U3B	U3C	U3D	UNIT
Device marking code		U3B	U3C	U3D	
Maximum repetitive peak reverse voltage	V_{RRM}	100	150	200	V
Maximum average forward rectified current (Fig. 1)	$T_M = 134$ °C $T_M = 125$ °C	$I_{F(AV)}$	2.0 ⁽¹⁾ 3.0 ⁽²⁾		A
Peak forward surge current 8.3 ms single half sine-wave superimposed on rated load	I_{FSM}	100			A
Operating junction and storage temperature range	T_J, T_{STG}	- 55 to + 150			°C

Notes:

- (1) Free air, mounted on recommended copper pad area
- (2) Units mounted on P.C.B. with 0.47 x 0.47" (12 x 12 mm) copper pad areas.



ELECTRICAL CHARACTERISTICS (T _A = 25 °C unless otherwise noted)						
PARAMETER	TEST CONDITIONS		SYMBOL	TYP.	MAX.	UNIT
Instantaneous forward voltage ⁽¹⁾	I _F = 3.0 A	T _A = 25 °C T _A = 100 °C	V _F	0.85 0.74	0.90 0.83	V
Reverse current ⁽²⁾	rated V _R	T _A = 25 °C T _A = 100 °C	I _R	- 250	10 500	μA
Reverse recovery time	I _F = 0.5 A, I _R = 1.0 A, I _{rr} = 0.25 A	T _A = 25 °C	t _{rr}	-	20	ns
	I _F = 3.0 A, di/dt = 50 A/μs, V _R = 30 V, I _{rr} = 0.1 I _{RM}	T _A = 25 °C T _A = 100 °C	t _{rr}	25 35	30 50	ns
Storage charge	I _F = 3.0 A, di/dt = 50 A/μs, V _R = 30 V, I _{rr} = 0.1 I _{RM}	T _A = 25 °C T _A = 100 °C	Q _{rr}	9 22	15 35	nC
Typical junction capacitance	4.0 V, 1 MHz		C _J	25	-	pF

Notes:

- (1) Pulse test: 300 μs pulse width, 1 % duty cycle
- (2) Pulse test: Pulse width ≤ 40 ms

THERMAL CHARACTERISTICS (T _A = 25 °C unless otherwise noted)					
PARAMETER	SYMBOL	U3B	U3C	U3D	UNIT
Typical thermal resistance ⁽¹⁾	R _{θJA}	92			°C/W
	R _{θJM}	10			

Note:

- (1) Free air, mounted on recommended copper pad area. Thermal resistance R_{θJA} - junction to ambient, R_{θJM} - junction to mount

ORDERING INFORMATION (Example)				
PREFERRED P/N	UNIT WEIGHT (g)	PREFERRED PACKAGE CODE	BASE QUANTITY	DELIVERY MODE
U3D-E3/57T	0.239	57T	850	7" diameter plastic tape and reel
U3D-E3/9AT	0.239	9AT	3500	13" diameter plastic tape and reel

RATINGS AND CHARACTERISTICS CURVES

(T_A = 25 °C unless otherwise noted)

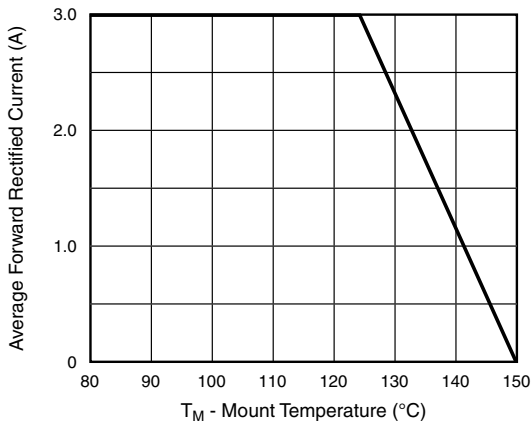

Figure 1. Maximum Forward Current Derating Curve

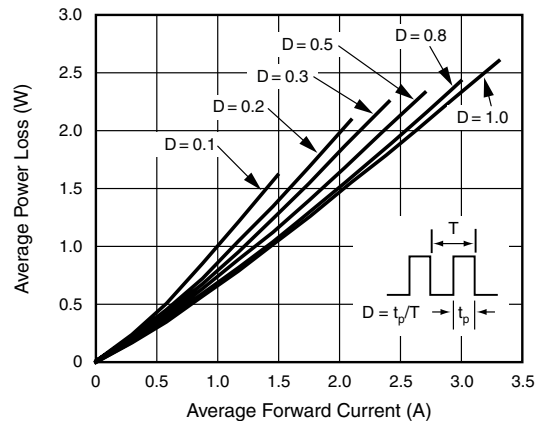

Figure 2. Forward Power Loss Characteristics

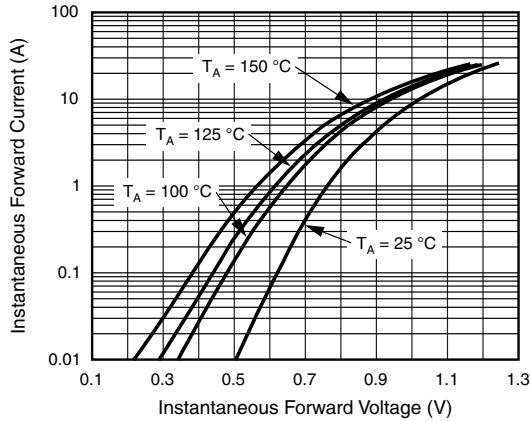

Figure 3. Typical Instantaneous Forward Characteristics

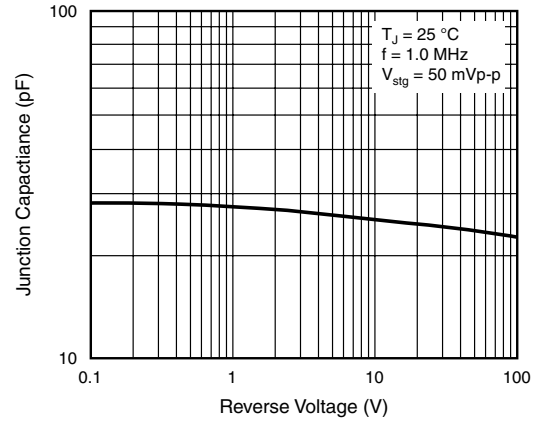

Figure 5. Typical Junction Capacitance

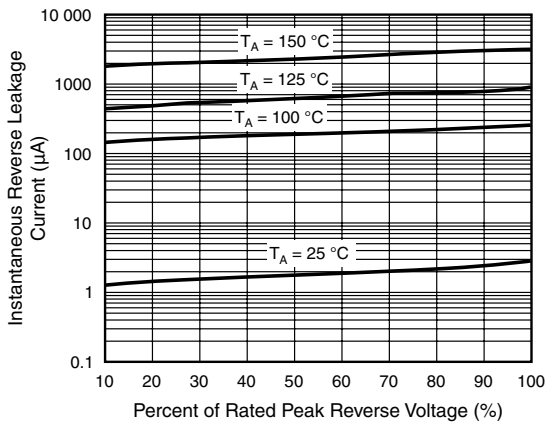

Figure 4. Typical Reverse Leakage Characteristics

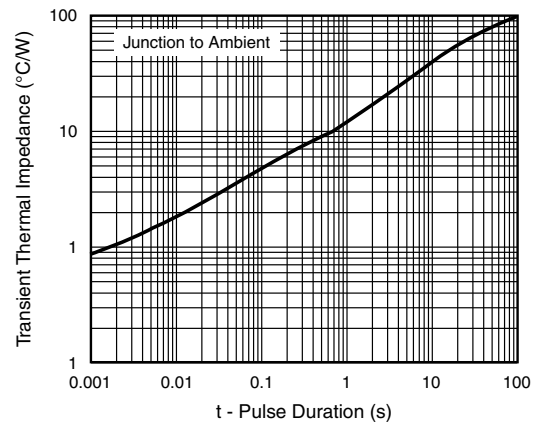
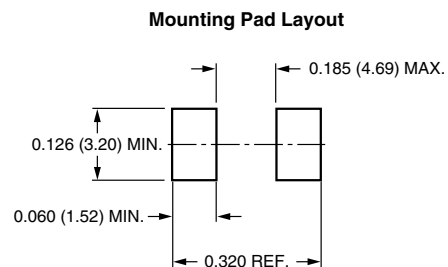
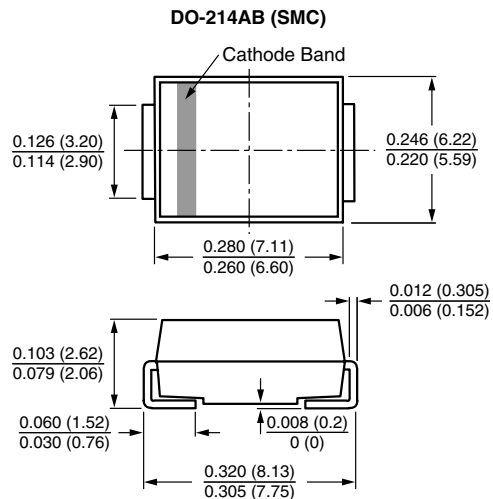

Figure 6. Typical Transient Thermal Impedance

PACKAGE OUTLINE DIMENSIONS in inches (millimeters)





Disclaimer

All product specifications and data are subject to change without notice.

Vishay Intertechnology, Inc., its affiliates, agents, and employees, and all persons acting on its or their behalf (collectively, "Vishay"), disclaim any and all liability for any errors, inaccuracies or incompleteness contained herein or in any other disclosure relating to any product.

Vishay disclaims any and all liability arising out of the use or application of any product described herein or of any information provided herein to the maximum extent permitted by law. The product specifications do not expand or otherwise modify Vishay's terms and conditions of purchase, including but not limited to the warranty expressed therein, which apply to these products.

No license, express or implied, by estoppel or otherwise, to any intellectual property rights is granted by this document or by any conduct of Vishay.

The products shown herein are not designed for use in medical, life-saving, or life-sustaining applications unless otherwise expressly indicated. Customers using or selling Vishay products not expressly indicated for use in such applications do so entirely at their own risk and agree to fully indemnify Vishay for any damages arising or resulting from such use or sale. Please contact authorized Vishay personnel to obtain written terms and conditions regarding products designed for such applications.

Product names and markings noted herein may be trademarks of their respective owners.