

General Description

KR Electronics part number 3328-SMA is a 865 MHz Bandpass filter. The filter has a typical 3 dB bandwidth of 250 MHz. Other center frequencies and bandwidths are available. Please consult the factory.

Features

- 865 MHz Bandpass Filter
- 3 dB Bandwidth 430 MHz
- 80 dB Bandwidth 542 MHz typical
- 50 Ω Source and Load
- SMA Connectors
- Surface Mount Available
- Other frequencies available

Typical Performance

Overall Response
(10 dB/div)

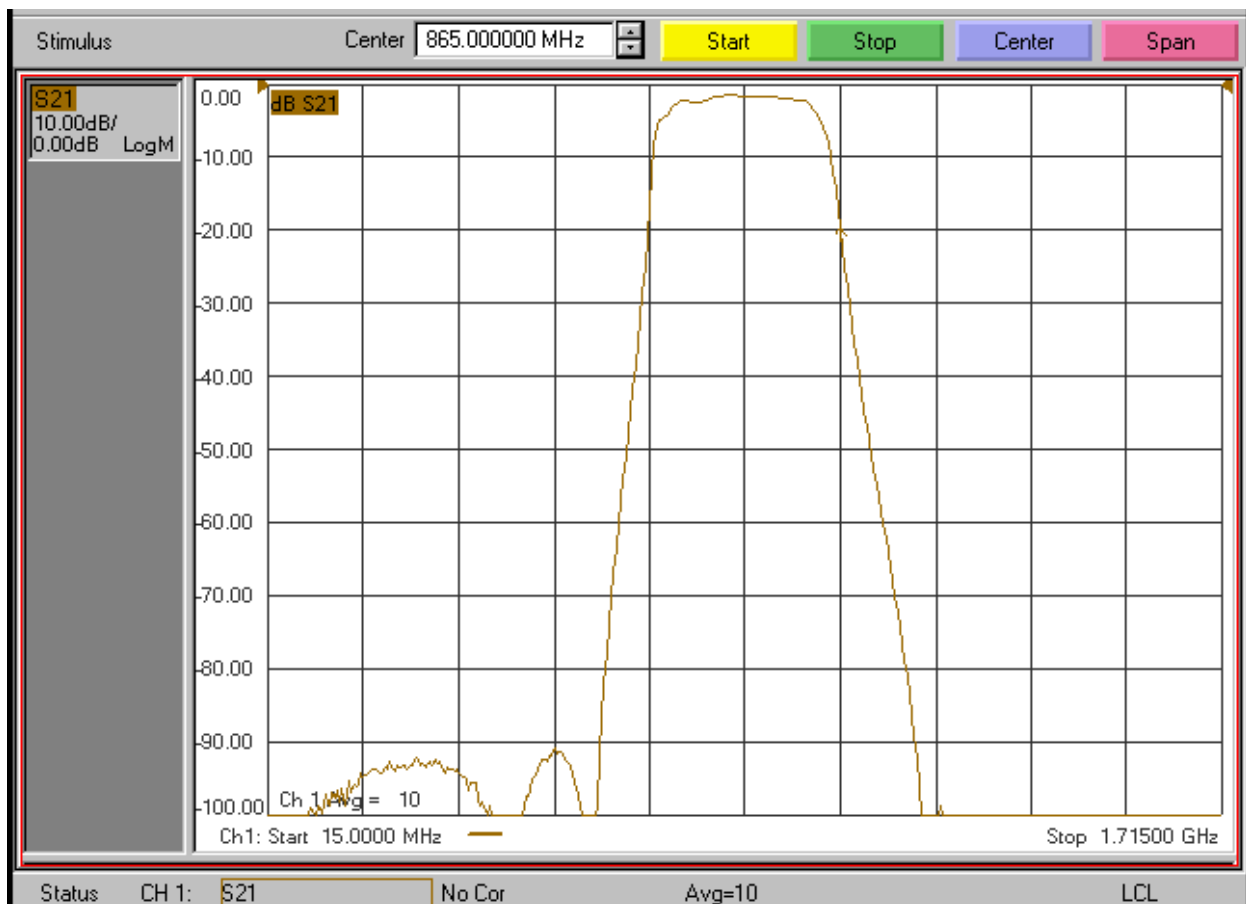

KR Electronics 3328-SMA

Passband Amplitude & Group Delay (1 dB/div & 10 nsec/div)

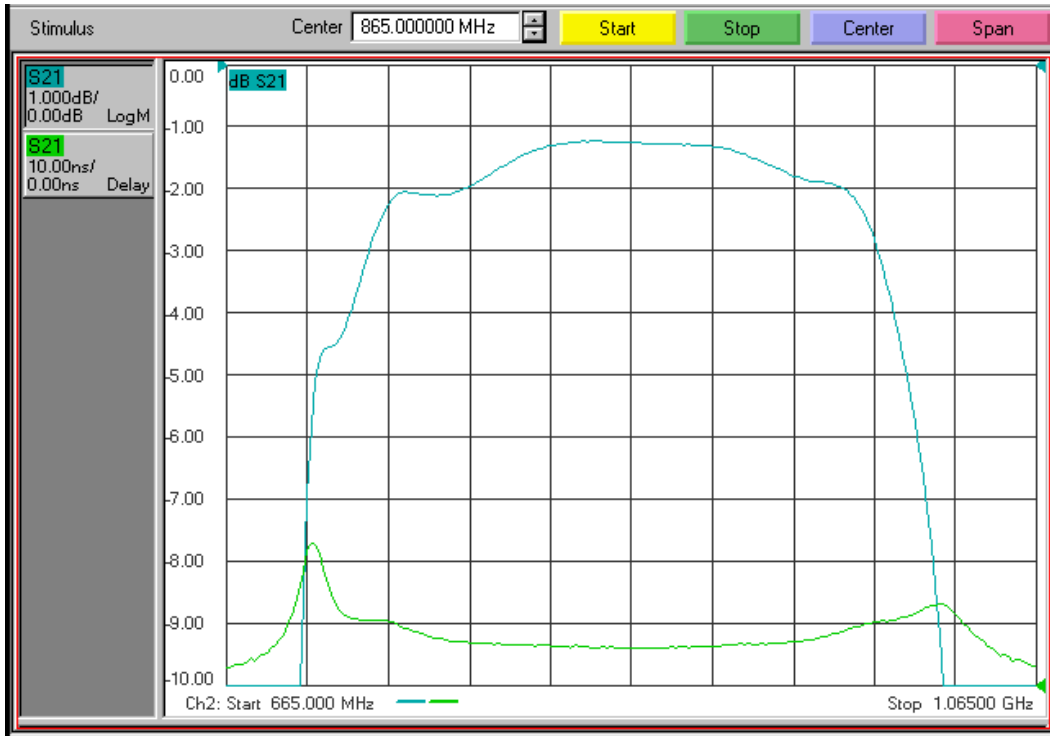

Overall Response
(12 dB/div)

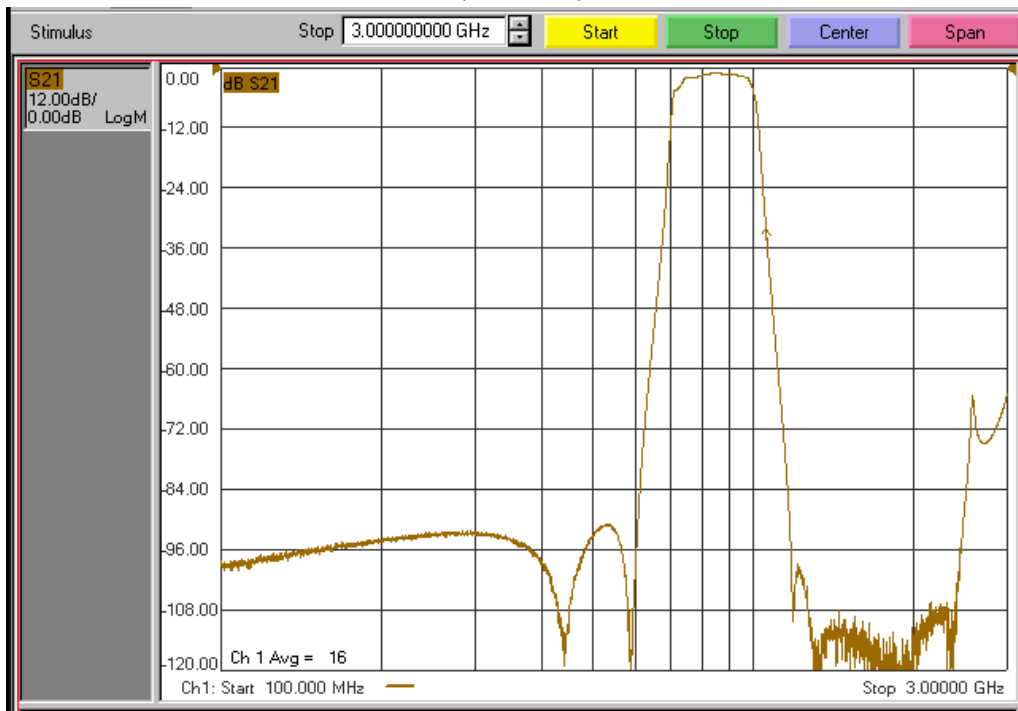

KR Electronics, Inc.
91 Avenel Street
Avenel, NJ 07001

Web www.krfilters.com
Email sales@krfilters.com
Phone (732) 636-1900
Fax (732) 636-1982

KR Electronics 3328-SMA

Specifications

Parameter	Specification	Notes
Filter type	Bandpass	
Center Frequency	865 MHz	
Insertion Loss at Fc	2.6 dBa max	1.25 dBa typical
3 dBc Bandwidth	250 MHz min	270 MHz typical
40 dBc Bandwidth	410 MHz typical	
60 dBc Bandwidth	480 MHz typical	
80 dBc Bandwidth	600 MHz max	540 MHz typical
Source and Load	50 Ω	

Physical Dimensions

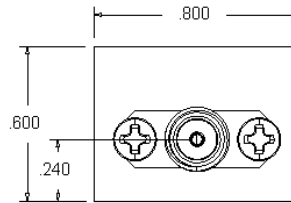
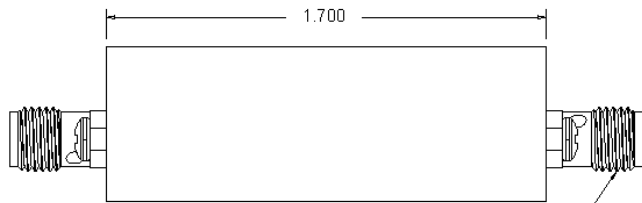
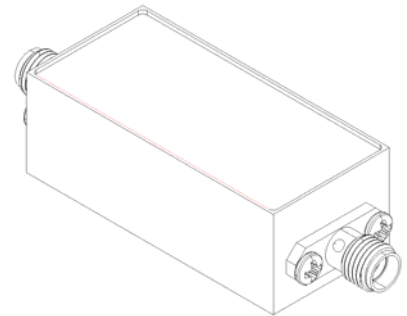
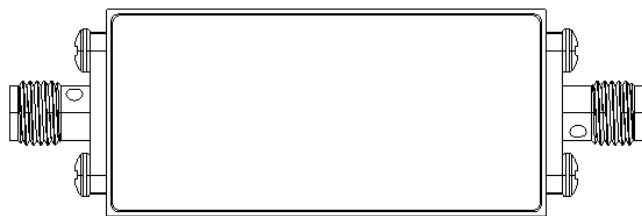

SMA(F) CONNECTOR 2x

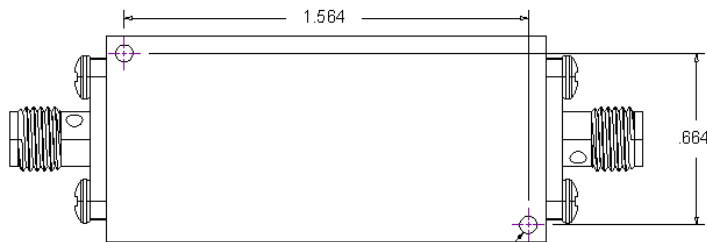

2-56 UNC-2B MOUNTING HOLES 2x
0.25 DEEP

Notes:

1. Dimensions in inches
2. Also available in surface mount package

KR Electronics, Inc.
91 Avenel Street
Avenel, NJ 07001

Web www.krfilters.com
Email sales@krfilters.com
Phone (732) 636-1900
Fax (732) 636-1982