

### UNIVERSAL ISM BAND FSK TRANSCEIVER MODULE

## RFM12B

(the purpose of this spec covers mainly for the physical characteristic of the module, for register configure and its related command info please refer to [RF12B data sheets](#))

### General Introduction

RFM12B is a low costing ISM band transceiver module implemented with unique PLL. It works signal ranges from 433/868/915MHZ bands, comply with FCC, ETSI regulation. The SPI interface is used to communicate with microcontroller for parameter setting.

### Features:

- Low costing, high performance and price ratio
- Tuning free during production
- PLL and zero IF technology
- Fast PLL lock time
- High resolution PLL with 2.5 KHz step
- High data rate (up to 115.2 kbps with internal demodulator, with external RC filter highest data rate is 256 kbps)
- Differential antenna input/output
- Automatic antenna tuning
- Programmable TX frequency deviation (from 15 to 240 KHz)
- Programmable receiver bandwidth (from 67 to 400 kHz)
- Analog and digital signal strength indicator (ARSSI/DRSSI)
- Automatic frequency control (AFC)
- Data quality detection (DQD)
- Internal data filtering and clock recovery
- RX synchron pattern recognition
- SPI compatible serial control interface
- Clock and reset signal output for external MCU use
- 16 bit RX Data FIFO
- Two 8 bit TX data registers
- Standard 10 MHz crystal reference
- Wakeup timer
- 2.2V – 3.8V power supply
- Low power consumption
- Standby current less than 0.3uA
- Supports very short packets (down to 3 bytes)

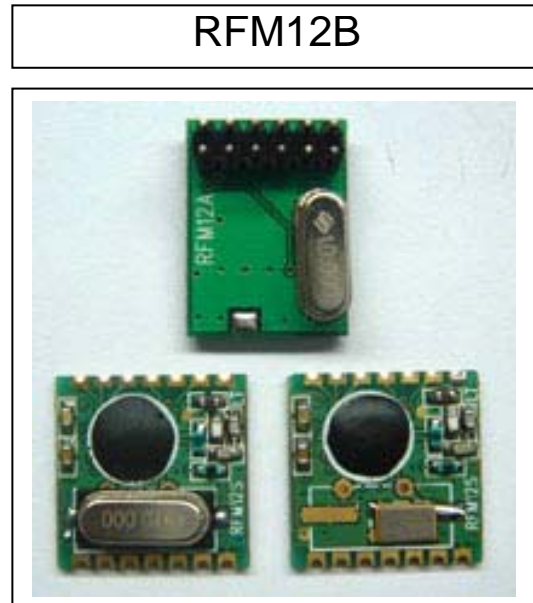

### Typical Application:

- Remote control
- Remote sensor
- Wireless data collection
- Home security system
- Toys
- Tire pressure monitoring system

### Pin Definition:

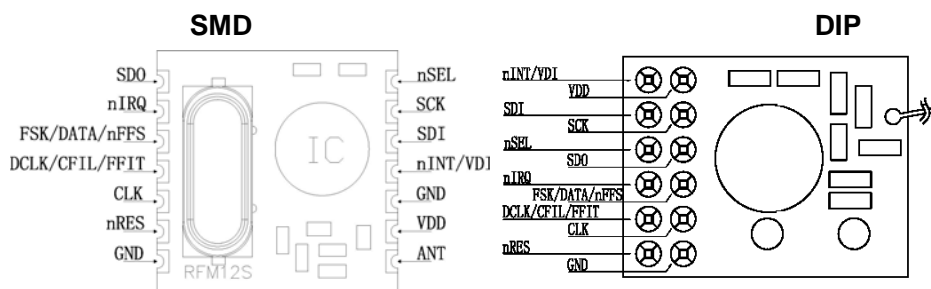

definition	Type	Function
nINT/VDI	DI/ DO	Interrupt input (active low)/Valid data indicator
VDD	S	Positive power supply
SDI	DI	SPI data input
SCK	DI	SPI clock input
nSEL	DI	Chip select (active low)
SDO	DO	Serial data output with bus hold
nIRQ	DO	Interrupts request output (active low)
FSK/DATA/nFFS	DI/DO/DI	Transmit FSK data input/ Received data output (FIFO not used)/ FIFO select
DCLK/CFIL/FFIT	DO/AIO/DO	Clock output (no FIFO )/ external filter capacitor(analog mode)/ FIFO interrupts(active high)when FIFO level set to 1, FIFO empty interruption can be achieved
CLK	DO	Clock output for external microcontroller
nRES	DIO	Reset output (active low)
GND	S	Power ground

### Electrical Parameter:

#### Maximum (not at working mode)

symbol	parameter	minimum	maximum	Unit
V <sub>dd</sub>	Positive power supply	-0.5	6.0	V
V <sub>in</sub>	All pin input level	-0.5	V <sub>dd</sub> +0.5	V

I <sub>in</sub>	Input current except power	-25	25	mA
ESD	Human body model		1000	V
T <sub>st</sub>	Storage temperature	-55	125	°C
T <sub>ld</sub>	Soldering temperature(10s)		260	°C

### Recommended working range

symbol	parameter	minimum	maximum	Unit
V <sub>dd</sub>	Positive power supply	2.2	3.8	V
T <sub>op</sub>	Working temperature	-40	85	°C

### DC characteristic

symbol	parameter	Remark	minimum	typical	maximum	Unit
I <sub>dd_TX_0</sub>	Supply current (TX mode, P <sub>out</sub> = 0dBm)	315,433MHz band 868MHz band 915MHz band		15 16 17	17 18 19	mA
I <sub>dd_TX_PMAX</sub>	Supply current (TX mode, P <sub>out</sub> = P <sub>max</sub> )	315,433MHz band 868MHz band 915MHz band		22 23 24	24 25 26	mA
I <sub>dd_RX</sub>	Supply current (RX mode)	315,433MHz band 868MHz band 915MHz band		11 12 13	13 14 15	mA
I <sub>x</sub>	Idle current	Crystal oscillator on		0.62	1.2	mA
I <sub>pd</sub>	Sleep mode current	All blocks off		0.3		uA
I <sub>lb</sub>	Low battery detection			0.5		uA
V <sub>lb</sub>	Low battery detect threshold	0.1V per step	2.2		3.7	V
V <sub>lba</sub>	Low battery detection accuracy		0		5	%
V <sub>il</sub>	Low level input				0.3*V <sub>dd</sub>	V
V <sub>ih</sub>	High level input		0.7*V <sub>dd</sub>			V
I <sub>ij</sub>	Leakage current	V <sub>ij</sub> =0V	-1		1	uA
I <sub>ih</sub>	Leakage current	V <sub>ih</sub> =V <sub>dd</sub> , V <sub>dd</sub> =5.4V	-1		1	uA
V <sub>ol</sub>	Low level output	I <sub>ol</sub> =2mA			0.4	V
V <sub>oh</sub>	High level output	I <sub>oh</sub> =-2mA	V <sub>dd</sub> -0.4			V

### AC characteristic

symbol	parameter	remark	min	typical	max	Unit
f <sub>ref</sub>	PLL frequency		9	10	11	MHz
f <sub>LO</sub>	frequency (10MHz crystal used)	433 MHz band,2.5KHz step 868 MHz band,5KHz step 915 MHz band,7.5KHz step	430.24 860.48 900.72		439.7 5 879.5 1 929.2 7	MHz

f <sub>LO</sub>	frequency (9MHz crystal used)	433 MHz band,2.5KHz step 868 MHz band,5KHz step 915 MHz band,7.5KHz step	387.22 774.43 810.65		395.7 6 791.5 6 836.3 4	MHz
f <sub>LO</sub>	frequency (11MHz crystal used)	433 MHz band,2.5KHz step 868 MHz band,5KHz step 915 MHz band,7.5KHz step	473.26 946.53 990.79		483.7 3 967.4 6 1022. 2	MHz
BW	Receiver bandwidth	mode 0 mode 1 mode 2 mode 3 mode 4 mode 5	60 120 180 240 300 360	67 134 200 270 350 400	75 150 225 300 375 450	KHz
t <sub>lock</sub>	PLL lock time	After 10MHz step hopping, frequency error <10 kHz		30		us
t <sub>st, P</sub>	PLL startup time	With a running crystal oscillator		200	300	us
BR	Data rate	With internal digital demodulator	0.6		115.2	kbps
BR <sub>A</sub>	Data rate	With external RC filter			256	kbps
P <sub>min</sub>	sensitivity	BER 10 <sup>-3</sup> , BW=134KHz,BR=1.2kbps, 433MHz band		-109	-100	dBm
		BER 10 <sup>-3</sup> , BW=134KHz,BR=1.2kbps, 868MHz band		-105	-100	
		BER 10 <sup>-3</sup> , BW=134KHz,BR=1.2kbps, 915MHz band		-105	-100	
AFC <sub>range</sub>	AFC working range	df <sub>FSK</sub> : FSK deviation in the received signal		0.8* df <sub>FSK</sub>		
RS <sub>A</sub>	RSSI accuracy			±5		dB
RS <sub>R</sub>	RSSI range			46		dB
C <sub>ARSSI</sub>	ARSSI filter			1		nF
RS <sub>STEP</sub>	RSSI programmable step			6		dB
RS <sub>RESP</sub>	DRSSI response time	RSSI output high after valid , CARRSI=5nF		500		us

### AC characteristic(Transmitter)

symbol	parameter	remark	min	typical	max	Unit
P <sub>max</sub>	Max. available output power	433MHz band	3	5		dBm
		868MHz band	2	4		
		915MHz band	2	4		
P <sub>out</sub>	Typical output power	Selectable in 3 dB steps	P <sub>max</sub> -21		P <sub>max</sub>	dbm
C <sub>o</sub>	Output capacitance (set by the automatic antenna tuning circuit)	In low bands	2	2.6	3.2	pf
		In high bands	2.1	2.7	3.3	
Q <sub>o</sub>	Quality factor of the output capacitance	In low bands	13	15	17	
		In high bands	8	10	12	
L <sub>out</sub>	Output phase noise	100 kHz from carrier 1 MHz from carrier			-80 -103	dbc/HZ
BR <sub>TX</sub>	FSK bit rate	Via internal TX data register			172	kbps
BRA <sub>TX</sub>	FSK bit rate	TX data connected to the FSK input			256	kbps
df <sub>fsk</sub>	FSK frequency deviation	Programmable in 15 kHz steps	15		240	kHZ

### AC characteristic(Turn-on/Turnaround timings)

symbol	parameter	remark	min	typical	max	Unit
T <sub>st</sub>	Crystal oscillator startup time	Crystal ESR < 100		1	5	ms
T <sub>tx_XTAL_ON</sub>	Transmitter turn-on time	Synthesizer off, crystal oscillator on with 10 MHz step		250		us
T <sub>rx_XTAL_ON</sub>	Receiver turn-on time	Synthesizer off, crystal oscillator on with 10 MHz step		250		us
T <sub>tx_rx_SYNT_ON</sub>	Transmitter – Receiver turnover time	Synthesizer and crystal oscillator on during TX/RX change with 10 MHz step		150		us
T <sub>rx_tx_SYNT_ON</sub>	Receiver – Transmitter turnover time	Synthesizer and crystal oscillator on during RX/TX change with 10 MHz step		150		us
C <sub>xl</sub>	Crystal load capacitance	Programmable in 0.5 pF steps, tolerance+/- 10%	8.5		16	pf
t <sub>POR</sub>	Internal POR timeout	After V <sub>dd</sub> has reached 90% of final value			100	ms
t <sub>PBt</sub>	Wake-up timer clock period	Calibrated every 30 seconds	0.96		1.05	ms
C <sub>in, D</sub>	Digital input apacitance				2	pf
t <sub>r, f</sub>	Digital output rise/fall time	15pF pure capacitive load			10	ns

## Field testing range

Band	Test condition	Distance
433MHz band	Receiver bandwidth =67KHz, data rate=1.2kbps, transmitter frequency deviation =45KHZ (matches with RFM12) In free open area	>200M
868MHz band	Receiver bandwidth=67KHz,data rate =1.2kbps,Transmitter frequency deviation =45KHZ (matches with RFM12) in free open area	>200M
915MHz band	Receiver bandwidth=67KHz,data rate =1.2kbps,Transmitter frequency deviation =45KHZ (matches with RFM12) in free open area	>200M

## SGS Reports

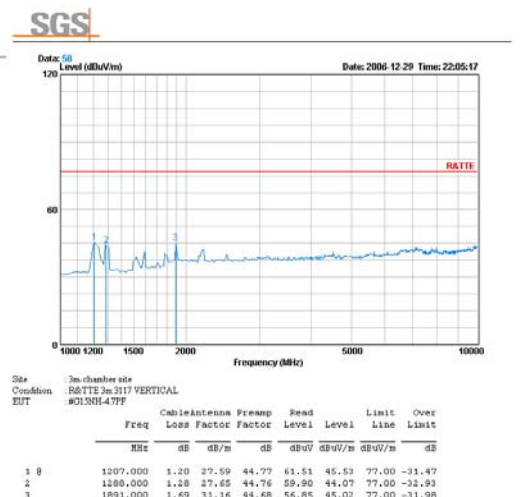
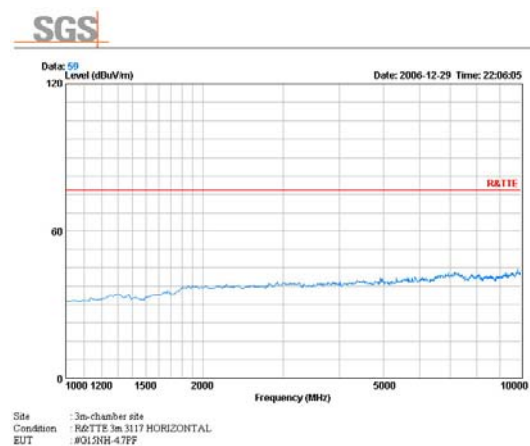
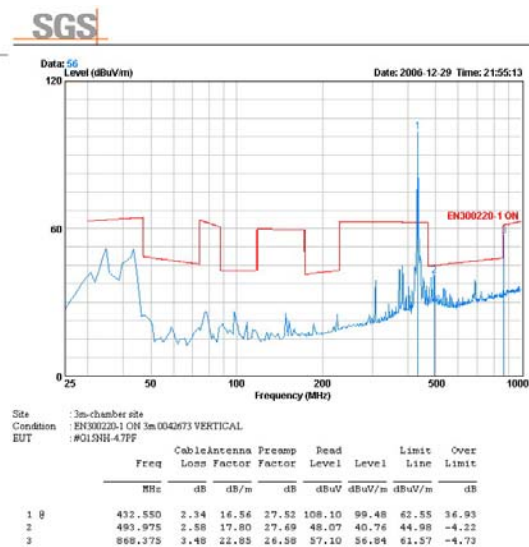
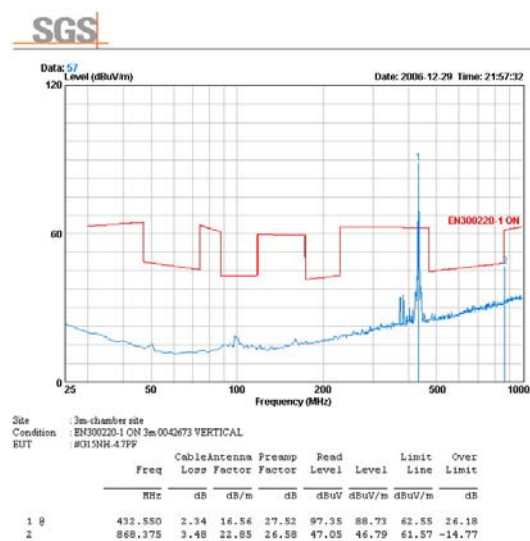

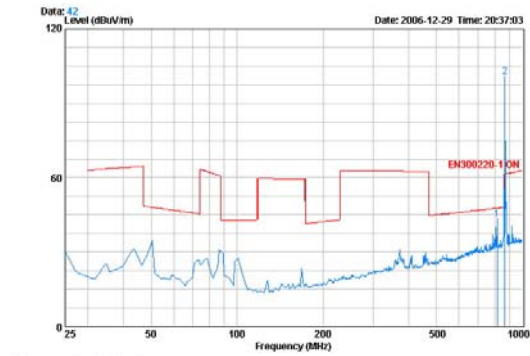

Site : 3m-chamber site  
Condition : EN300220-1 CN 3m 0040673 HORIZONTAL  
EUT : #D-63NF

	Freq	Cable	Antenna	Preamp	Read	Limit	Over
	MHz	Loss	Factor	Factor	Level	Line	Limit
		dB	dB/m	dB	dBuV	dBuV/m	dBuV/m
1	816.700	3.20	22.29	26.06	44.32	43.04	47.80 -4.76
2	968.375	3.40	22.05	26.59	101.04	100.70	61.57 39.21

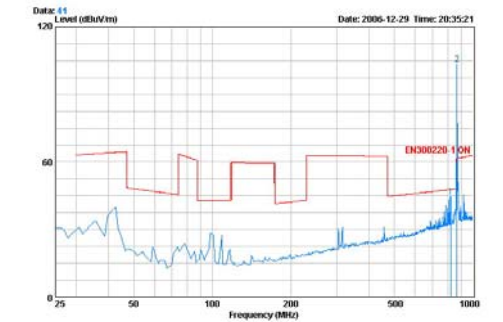

Site : 3m-chamber site  
Condition : EN300220-1 CN 3m 0040673 VERTICAL  
EUT : #D-63NF

	Freq	Cable	Antenna	Preamp	Read	Limit	Over
	MHz	Loss	Factor	Factor	Level	Line	Limit
		dB	dB/m	dB	dBuV	dBuV/m	dBuV/m
1	820.600	3.30	22.33	26.04	45.80	44.59	47.82 -3.24
2	868.375	3.48	22.85	26.58	103.62	103.36	61.57 41.79

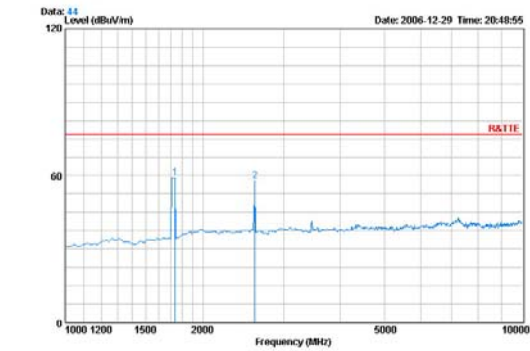

Site : 3m-chamber site  
Condition : R&TTE 3m 3117 HORIZONTAL  
EUT : #D-63NF

	Freq	Cable	Antenna	Preamp	Read	Limit	Over
	MHz	Loss	Factor	Factor	Level	Line	Limit
		dB	dB/m	dB	dBuV	dBuV/m	dBuV/m
1	1738.000	1.60	29.94	44.70	72.33	59.18	77.00 -17.83
2	2602.000	2.04	32.54	44.80	67.95	57.73	77.00 -19.27

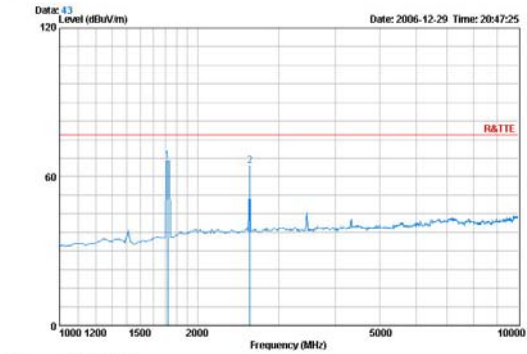

Site : 3m-chamber site  
Condition : R&TTE 3m 3117 VERTICAL  
EUT : #D-63NF

	Freq	Cable	Antenna	Preamp	Read	Limit	Over
	MHz	Loss	Factor	Factor	Level	Line	Limit
		dB	dB/m	dB	dBuV	dBuV/m	dBuV/m
1	1720.000	1.59	29.82	44.70	79.69	66.40	77.00 -10.60
2	2602.000	2.04	32.54	44.80	74.74	64.52	77.00 -12.48

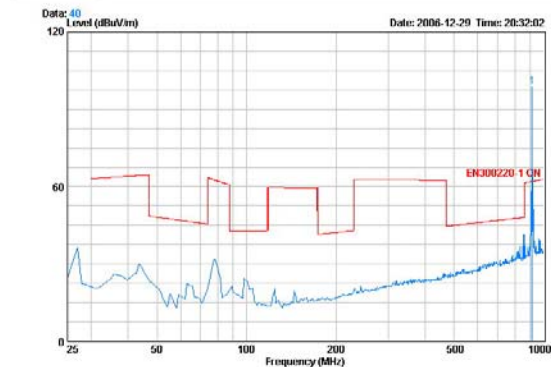

Site : 3m-chamber site  
Condition : EN300220-1 CN 3m 0040673 HORIZONTAL  
EUT : #F-63NF

	Freq	Cable	Antenna	Preamp	Read	Limit	Over
	MHz	Loss	Factor	Factor	Level	Line	Limit
		dB	dB/m	dB	dBuV	dBuV/m	dBuV/m
1	914.200	3.62	23.26	26.43	90.20	90.73	62.05 36.68

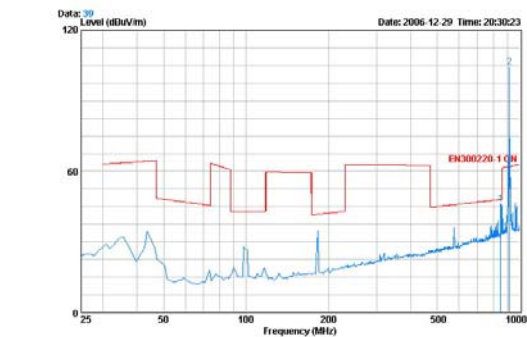

Site : 3m-chamber site  
Condition : EN300220-1 CN 3m 0040673 VERTICAL  
EUT : #F-63NF

	Freq	Cable	Antenna	Preamp	Read	Limit	Over
	MHz	Loss	Factor	Factor	Level	Line	Limit
		dB	dB/m	dB	dBuV	dBuV/m	dBuV/m
1	951.800	3.42	22.40	26.67	46.75	45.90	48.03 -2.06
2	914.200	3.62	23.26	26.43	103.62	104.27	62.05 42.22

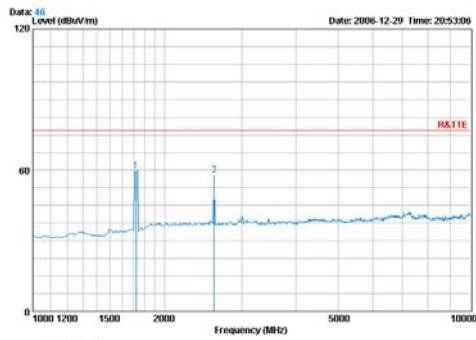

Line	Freq	Cable/Antenna		Preamp	Read	Level	Limit	Over
		Loss	Factor					
	MHz	dB	dB/m	dB	dBuV	dBuV/m	dBuV/m	dB
1	1720.000	1.59	29.82	44.70	72.93	59.63	77.00	-17.37
2	2602.000	2.04	32.54	44.60	67.94	57.72	77.00	-19.28

Site : 3m-chamber site  
Condition : R&TTE 3m 3117 HORIZONTAL  
EUT : #F-638P

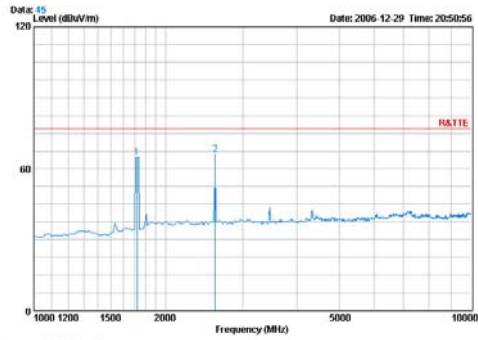

Line	Freq	Cable/Antenna		Preamp	Read	Level	Limit	Over
		Loss	Factor					
	MHz	dB	dB/m	dB	dBuV	dBuV/m	dBuV/m	dB
1	1720.000	1.59	29.82	44.70	76.10	64.80	77.00	-12.20
2	2602.000	2.04	32.54	44.60	76.30	66.00	77.00	-10.92

Site : 3m-chamber site  
Condition : R&TTE 3m 3117 VERTICAL  
EUT : #F-638P

## Mechanical Dimension

(units in mm)

### SMD PACKAGE (S1)

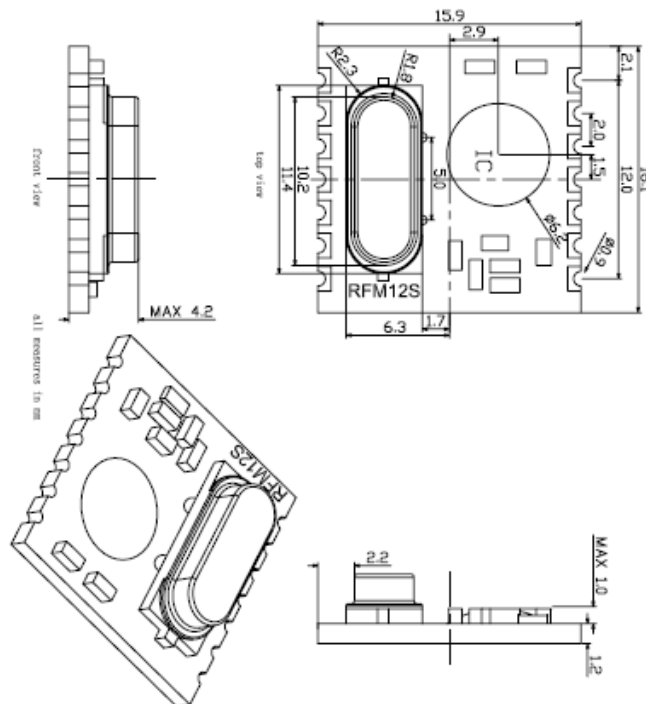

### SMD PACKAGE (S2)



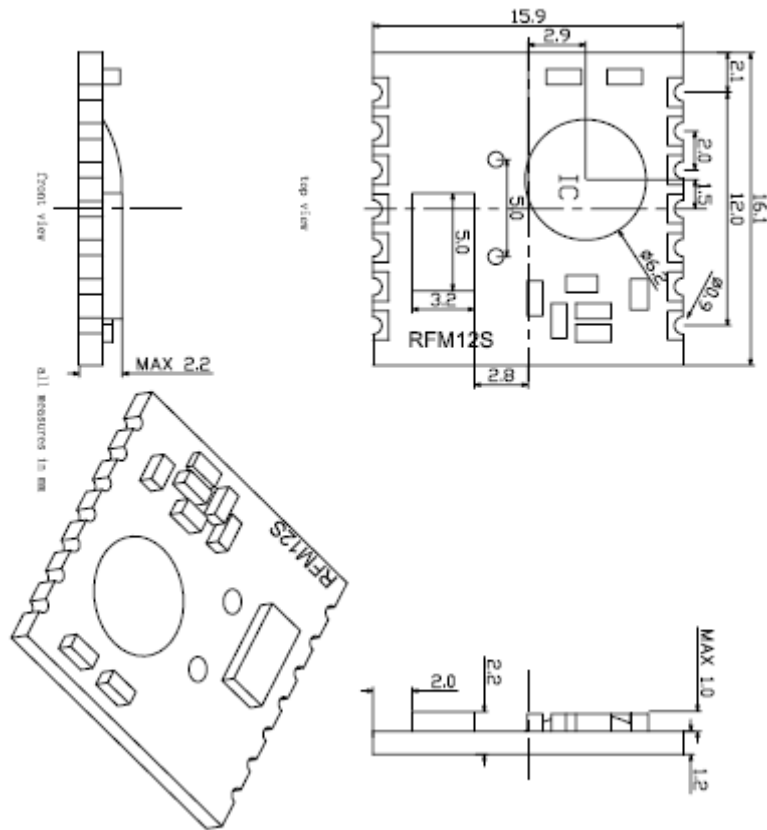

DIP PACKAGE (D)

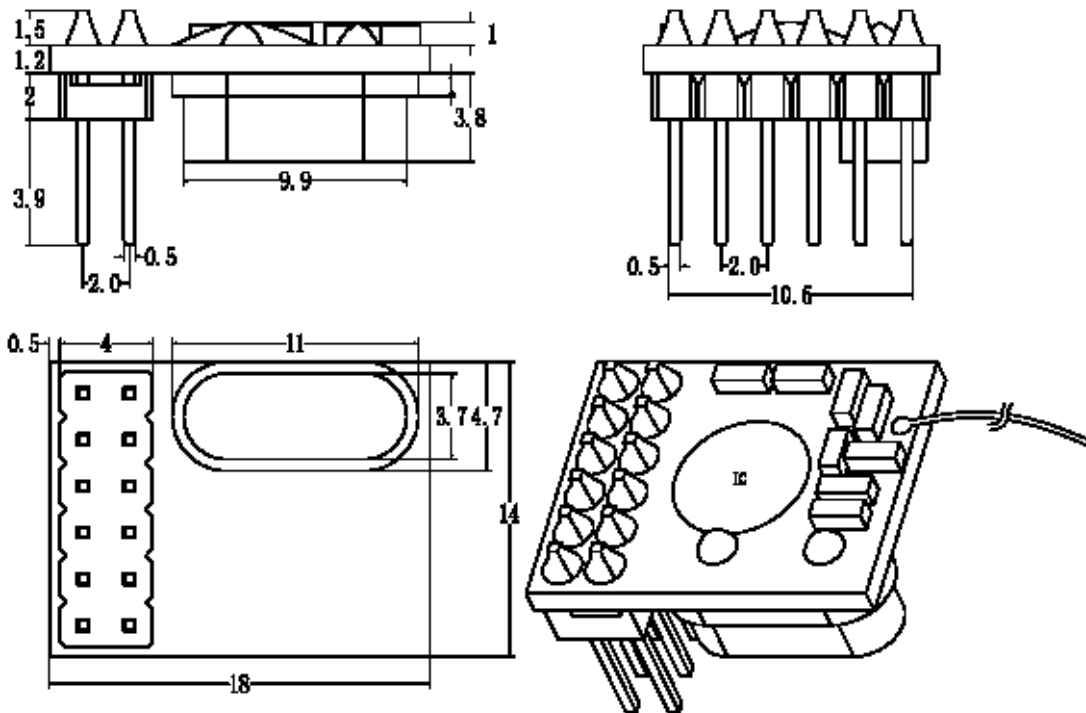

### Module Model Definition

model=module type+operation band+module package type+ core chip package type

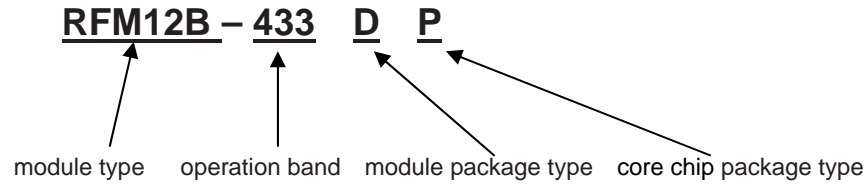

example:

- 1, RFM12B-433D : RFM12B module at 433MHz band, DIP module, die chip.
- 2, RFM12B-433DP : RFM12B module at 433MHz band, DIP module, package chip.
- 3, RFM12B-868S1 : RFM12B module at 868MHZ band, SMD module, thickness at 4.2mm,die chip.
- 4, RFM12B-868S1P: RFM12B module at 868MHZ band, SMD module, thickness at 4.2mm, package chip.
- 5, RFM12B-915S2 : RFM12B module at 915MHZ band, SMD module, thickness at 2.2mm,die chip.
- 6, RFM12B-915S2P: RFM12B module at 868MHZ band, SMD module, thickness at 4.2mm, package chip.

Module model	operation band	module package type	core chip package type
RFM12B-433D	433MHz	DIP	Die
RFM12B-433DP	433MHz	DIP	16pin TSSOP
RFM12B-433S1	433MHz	SMD, thickness at 4.2mm	Die
RFM12B-433S1P	433MHz	SMD, thickness at 4.2mm	16pin TSSOP
RFM12B-433S2	433MHz	SMD, thickness at 2.2mm	Die
RFM12B-433S2P	433MHz	SMD, thickness at 2.2mm	16pin TSSOP
RFM12B-868D	868MHz	DIP	Die
RFM12B-868DP	868MHz	DIP	16pin TSSOP
RFM12B-868S1	868MHz	SMD, thickness at 4.2mm	Die
RFM12B-868S1P	868MHz	SMD, thickness at 4.2mm	16pin TSSOP
RFM12B-868S1	868MHz	SMD, thickness at 2.2mm	Die
RFM12B-868S1P	868MHz	SMD, thickness at 2.2mm	16pin TSSOP
RFM12B-915D	915MHz	DIP	Die
RFM12B-915DP	915MHz	DIP	16pin TSSOP
RFM12B-915S1	915MHz	SMD, thickness at 4.2mm	Die
RFM12B-915S1P	915MHz	SMD, thickness at 4.2mm	16pin TSSOP
RFM12B-915S2	915MHz	SMD, thickness at 2.2mm	Die
RFM12B-915S2P	915MHz	SMD, thickness at 2.2mm	16pin TSSOP

All RFM12B module model and description

**HOPE MICROELECTRONICS CO.,LTD**

Add:4/F, Block B3, East Industrial Area,  
Huaqiaocheng, Shenzhen, Guangdong,  
China

Tel: 86-755-82973805

Fax: 86-755-82973550

Email: [sales@hoperf.com](mailto:sales@hoperf.com)  
[trade@hoperf.com](mailto:trade@hoperf.com)

Website: <http://www.hoperf.com>

<http://www.hoperf.cn>

<http://hoperf.en.alibaba.com>

This document may contain preliminary information and is subject to change by Hope Microelectronics without notice. Hope Microelectronics assumes no responsibility or liability for any use of the information contained herein. Nothing in this document shall operate as an express or implied license or indemnity under the intellectual property rights of Hope Microelectronics or third parties. The products described in this document are not intended for use in implantation or other direct life support applications where malfunction may result in the direct physical harm or injury to persons. NO WARRANTIES OF ANY KIND, INCLUDING, BUT NOT LIMITED TO, THE IMPLIED WARRANTIES OF MECHANICAL FITNESS OR FITNESS FOR A PARTICULAR PURPOSE, ARE OFFERED IN THIS DOCUMENT.

©2006, HOPE MICROELECTRONICS CO.,LTD. All rights reserved.