

HSMF-C116

Ultra Small Surface Mount Tricolor ChipLED

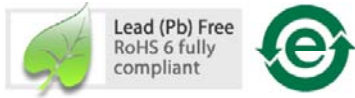

Data Sheet



Features

- LED with AlInGaP and InGaN die
- Surface mount device with ultra small 1.0 x 1.0mm footprint
- Suitable for application that requires small pitch size
- Compatible with reflow soldering
- Taped in 8mm carrier tape on a 7 inch diameter reel

Applications

- Display
- Backlighting
- Indicator

Package Dimensions

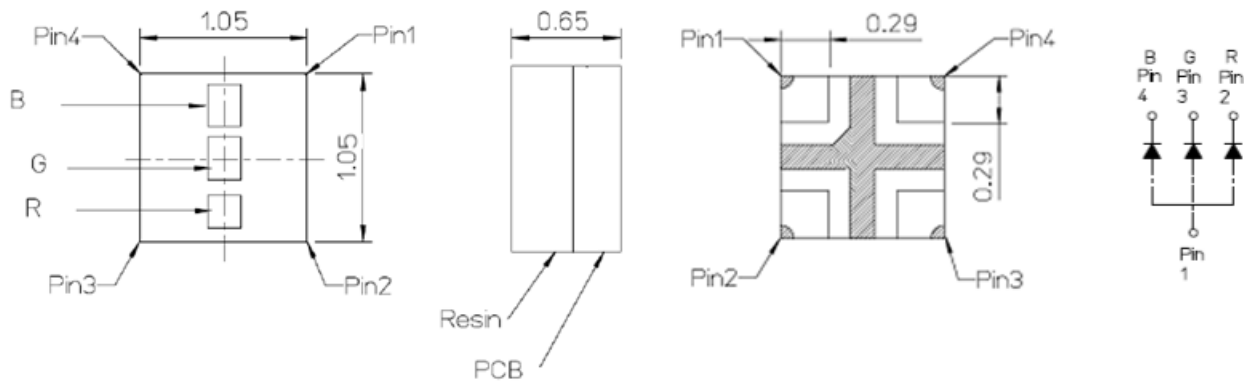

Notes:

1. All dimensions in millimeters.
2. Tolerance is ± 0.1 mm unless otherwise specified.

CAUTION: This LED is class 1A ESD sensitive per ANSI/ESDA/JEDEC JS-001. Please observe appropriate precautions during handling and processing. Refer to application note AN-1142 for additional details.

Absolute Maximum Ratings ($T_J = 25^\circ\text{C}$)

Parameter	AlInGaP Red	InGaN Green	InGaN Blue	Unit
DC Forward Current ^[1]	10	10	10	mA
Peak Forward Current ^[2]	60	60	60	mA
Power Dissipation	22	31	33	mW
LED Junction Temperature	95	95	95	$^\circ\text{C}$
Operating Temperature Range		-40 to 85		$^\circ\text{C}$
Storage Temperature Range		-40 to 85		$^\circ\text{C}$

Notes:

1. Derate linearly as shown in Figure 7.
2. 1/10 duty factor and 0.1ms pulse width.

Optical Characteristics ($T_J = 25^\circ\text{C}$, $R=10\text{mA}$, $G/B=5\text{mA}$)

Color	Luminous Intensity, $I_v(\text{mcd})$ ^[1]			Peak Wavelength, $\lambda_p(\text{nm})$	Dominant Wavelength, $\lambda_d(\text{nm})$ ^[2]	Viewing Angle, $2\theta_{1/2}(\text{°})$ ^[3]
	Min.	Typ.	Max.	Typ.	Typ.	Typ.
Red	63.0	80.0	140.0	631	622	137
Green	140.0	220.0	315.0	520	528	140
Blue	32.0	45.0	71.0	466	471	140

Notes:

1. The luminous intensity is measured at the mechanical axis of the LED package. The actual peak of the spatial radiation pattern may not be aligned with the axis.
2. The dominant wavelength is derived from the CIE chromaticity diagram and represents the perceived color of the device.
3. $\theta_{1/2}$ is the off axis angle where the luminous intensity is $\frac{1}{2}$ the peak intensity.

Electrical Characteristics ($T_J = 25^\circ\text{C}$, $R=10\text{mA}$, $G/B=5\text{mA}$)

Color	Forward Voltage, $V_F(\text{V})$ ^[1]		Reverse Voltage, $V_R(\text{V})$ ^[2] at $I_R=100\mu\text{A}$
	Min.	Max.	Min.
Red	1.8	2.2	5
Green	2.5	3.1	5
Blue	2.7	3.3	5

Notes:

1. Forward voltage tolerance $\pm 0.1\text{V}$.
2. Reverse voltage indicates product final test. Long term reverse bias is not recommended.

Bin Information

Intensity Bins (CAT) - Red

Bin ID	Luminous Intensity (mcd)	
	Min.	Max.
P2	63.0	100.0
Q	71.0	112.0
Q5	80.0	125.0
Q7	90.0	140.0

Tolerance: $\pm 15\%$

Color Bins (BIN) - Red

Bin ID	Dominant Wavelength (nm)	
	Min.	Max.
1	615.0	627.0

Tolerance: $\pm 1\text{nm}$

Intensity Bins (CAT) - Green

Bin ID	Luminous Intensity (mcd)	
	Min.	Max.
R7	140.0	224.0
R9	159.0	250.0
S	180.0	280.0
S5	201.0	315.0

Tolerance: $\pm 15\%$

Color Bins (BIN) - Green

Bin ID	Dominant Wavelength (nm)	
	Min.	Max.
2	523.0	529.0
3	525.0	531.0
4	528.0	534.0
5	530.0	536.0
6	533.0	539.0

Tolerance: $\pm 1\text{nm}$

Intensity Bins (CAT) - Blue

Bin ID	Luminous Intensity (mcd)	
	Min.	Max.
N5	32.0	50.0
N7	36.0	56.0
N9	40.0	63.0
P	45.0	71.0

Tolerance: $\pm 15\%$

Color Bins (BIN) - Blue

Bin ID	Dominant Wavelength (nm)	
	Min.	Max.
6	466.0	471.0
7	468.0	473.0
8	470.0	475.0

Tolerance: $\pm 1\text{nm}$

Caution:

1. The above optical performance specifications are valid in the case where single LED is lit up.
2. The above product specifications DO NOT provide any guarantee on color mixing, color consistency over time or uniformity in luminous intensity when more than 1 LED is lit up.

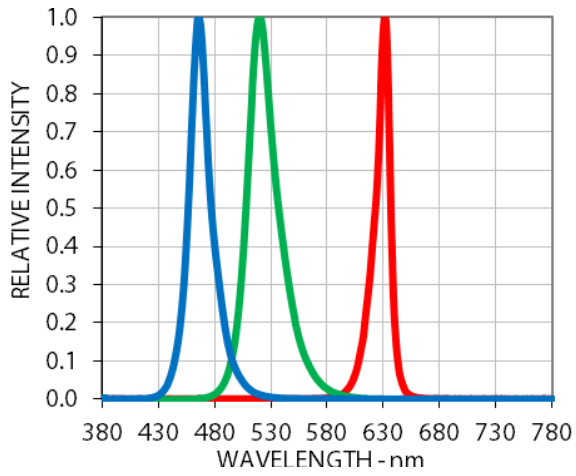

Figure 1. Spectral power dissipation

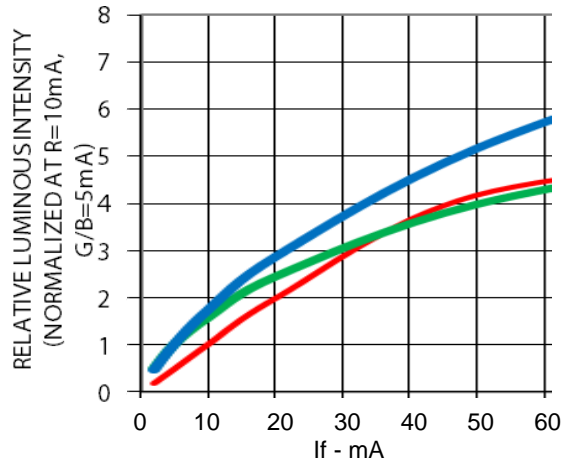

Figure 2. Relative intensity vs. forward current

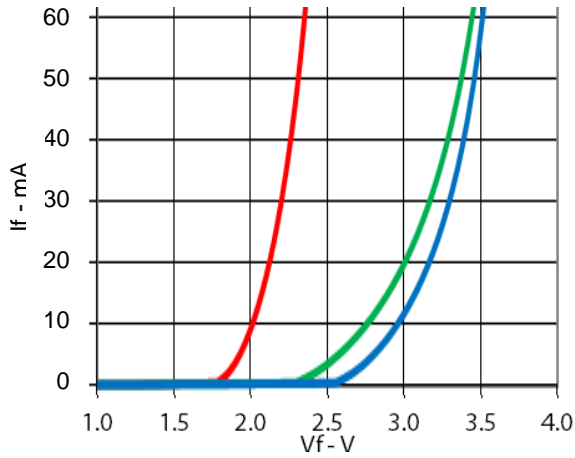

Figure 3. Forward current vs. forward voltage

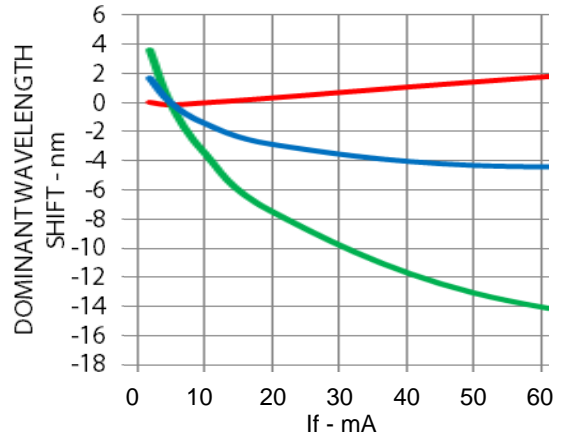

Figure 4. Dominant wavelength shift vs. forward current

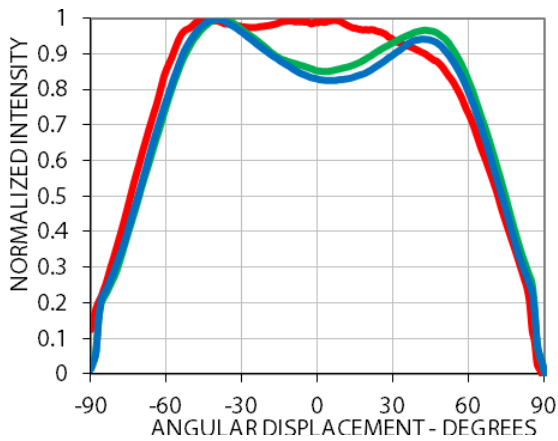

Figure 5. Radiation pattern

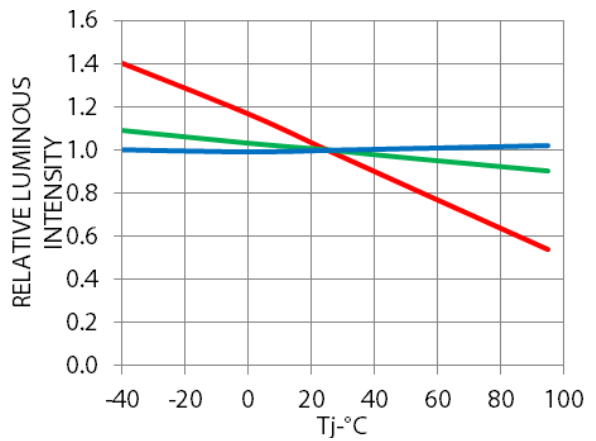

Figure 6. Relative intensity vs. temperature

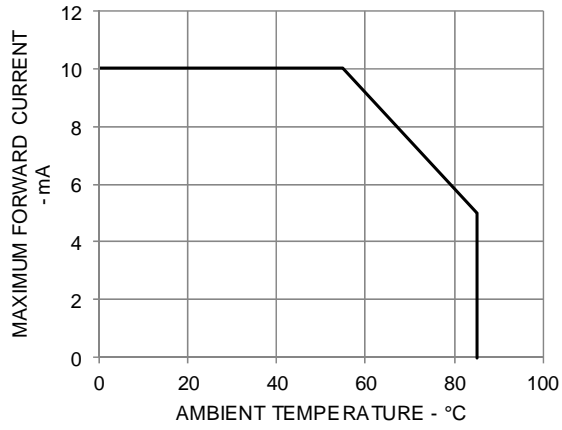

Figure 7. Derating curve

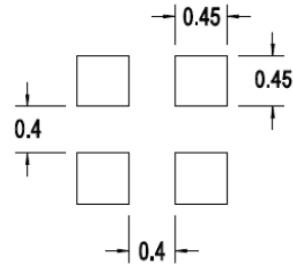
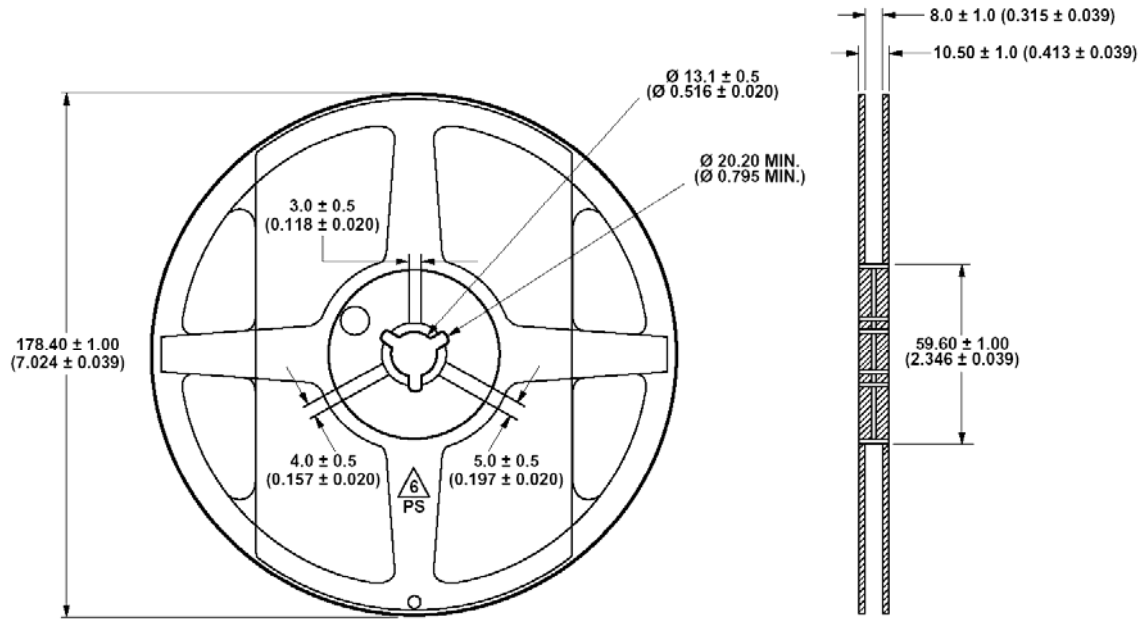

Figure 8. Recommended soldering land pattern



NOTE:
1. ALL DIMENSIONS IN MILLIMETERS (INCHES).

Figure 9. Reel dimensions

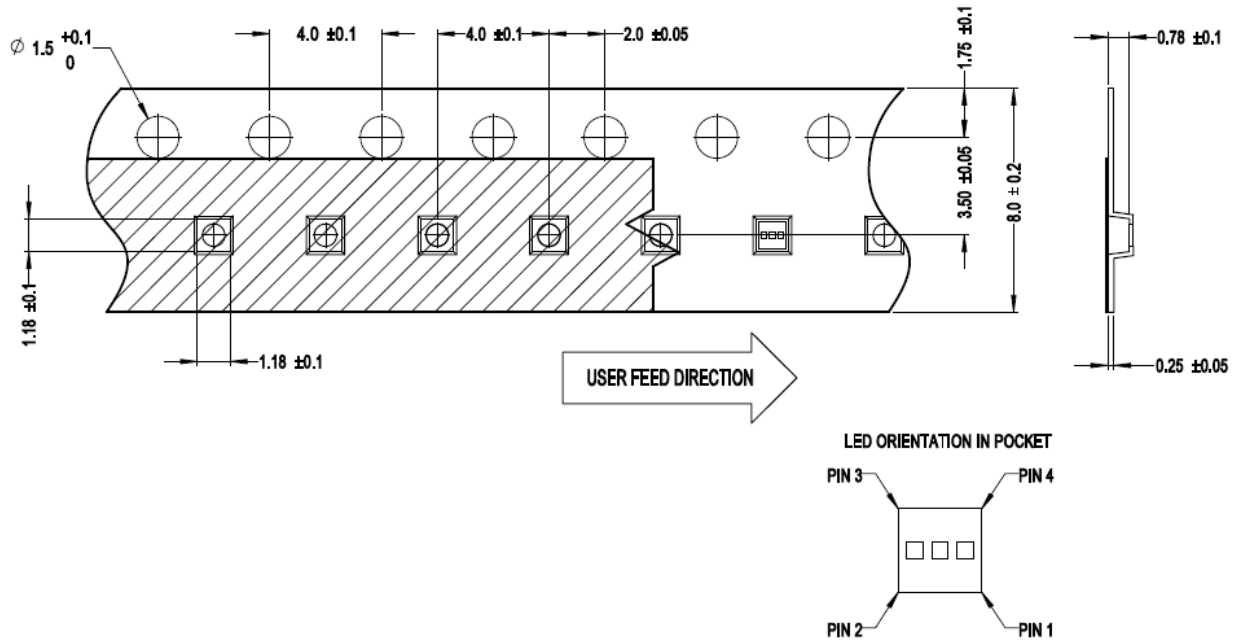
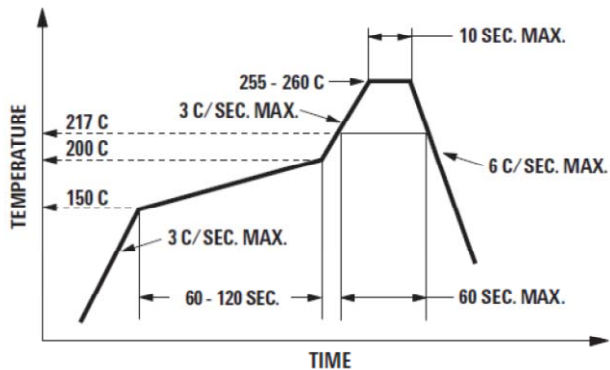

Figure 10. Carrier tape dimensions

Soldering

Recommended reflow soldering condition:



- Reflow soldering must not be done more than 2 times. Do observe necessary precautions of handling moisture sensitive device as stated in below section.
- Do not apply any pressure or force on the LED during reflow and after reflow when the LED is still hot.
- It is preferred to use reflow soldering to solder the LED. But if unavoidable (such as rework), manual hand soldering can be used but must be strictly controlled to condition below:
 - Soldering iron tip temperature = 310°C max
 - Soldering duration = 2sec max
 - Number of cycle = 1 only
 - Power of soldering iron = 50W max
- Do not touch the LED package body with the soldering iron except for the soldering terminals as it may cause damage to the LED.
- User is advised to confirm beforehand whether the functionality and performance of the LED is affected by hand soldering.

PRECAUTIONARY NOTES

1. Handling of moisture sensitive device

This product has a Moisture Sensitive Level 3 rating per JEDEC J-STD-020. Do refer to Avago Application Note AN5305, *Handling of Moisture Sensitive Surface Mount Devices*, for additional details and a review of proper handling procedures.

- (a) Before use
 - An unopened moisture barrier bag (MBB) can be stored at <40°C/90%RH for 12 months. If the actual shelf life has exceeded 12 months and the humidity Indicator Card (HIC) indicates that baking is not required, then it is safe to reflow the LEDs per the original MSL rating.
 - It is recommended that the MBB not be opened prior to assembly (e.g. for IQC).
- (b) Control after opening the MBB
 - The humidity indicator card (HIC) shall be read immediately upon opening of MBB.
 - The LEDs must be kept at <30°C / 60%RH at all times and all high temperature related processes including soldering, curing or rework need to be completed within 168 hours.
- (c) Control for unfinished reel
 - Unused LEDs must be stored in a sealed MBB with desiccant or desiccator at <5%RH.
- (d) Control of assembled boards
 - If the PCB soldered with the LEDs is to be subjected to other high temperature processes, the PCB need to be stored in sealed MBB with desiccant or desiccator at <5%RH to ensure that all LEDs have not exceeded their floor life of 168 hours.
- (e) Baking is required if:
 - The HIC indicator is not blue at 10% and is pink at 5%.
 - The LEDs are exposed to condition of >30°C / 60% RH at any time.
 - The LED floor life exceeded 168hrs.The recommended baking condition is: 60±5°C for 20hrs
Baking should only be done once.

Disclaimer

Avago's products are not specifically designed, manufactured or authorized for sale as parts, components or assemblies for the planning, construction, maintenance or direct operation of a nuclear facility or for use in medical devices or applications. Customer is solely responsible, and waives all rights to make claims against Avago or its suppliers, for all loss, damage, expense or liability in connection with such use.

For product information and a complete list of distributors, please go to our web site: www.avagotech.com

Avago, Avago Technologies, and the A logo are trademarks of Avago Technologies in the United States and other countries. Data subject to change. Copyright © 2005-2015 Avago Technologies. All rights reserved.
February 4, 2015

AVAGO
TECHNOLOGIES