

THIS DRAWING IS UNPUBLISHED. RELEASED FOR PUBLICATION DEC. 2004.  
 © COPYRIGHT 2004 BY TYCO ELECTRONICS CORPORATION. ALL RIGHTS RESERVED.

| LOC | DIST | REVISIONS<br>変更 |           |     |      |
|-----|------|-----------------|-----------|-----|------|
| P   | LTR  | DESCRIPTION     | DATE      | DWN | APVD |
|     | A    | REVISED         | 23JUN2010 | Y.W | S.K  |
|     | B    | ECR-13-012512   | 09AUG2013 | IT  | WKH  |

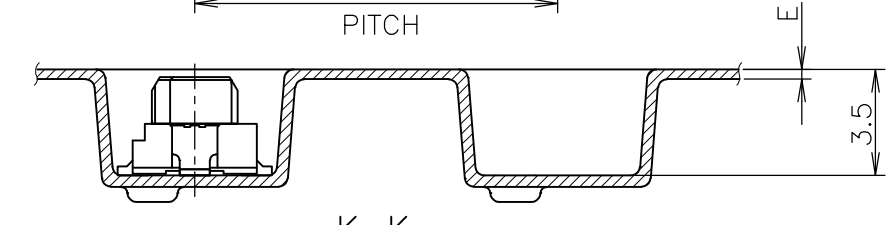

引出し方向  
TOP OF REEL →

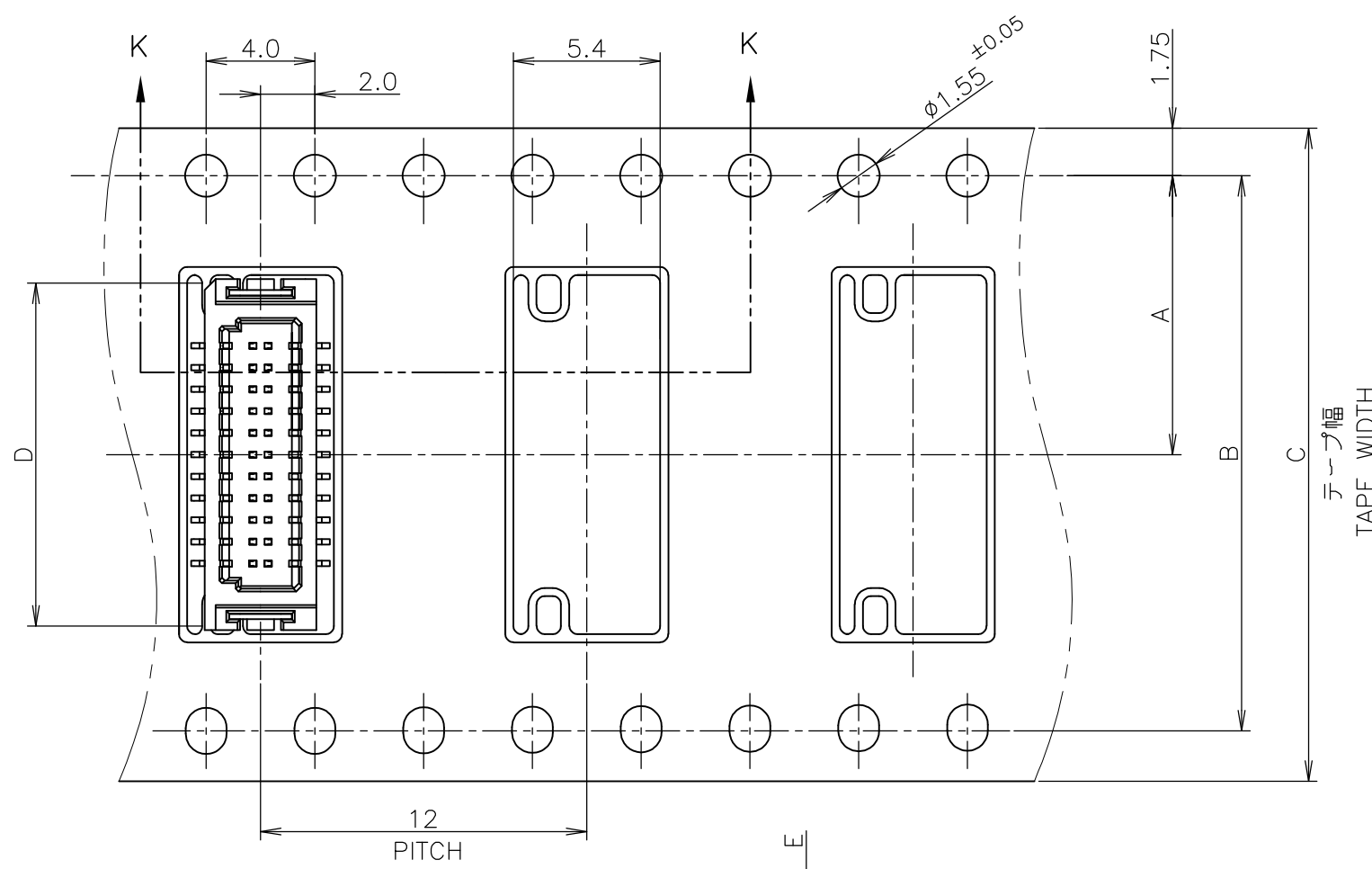
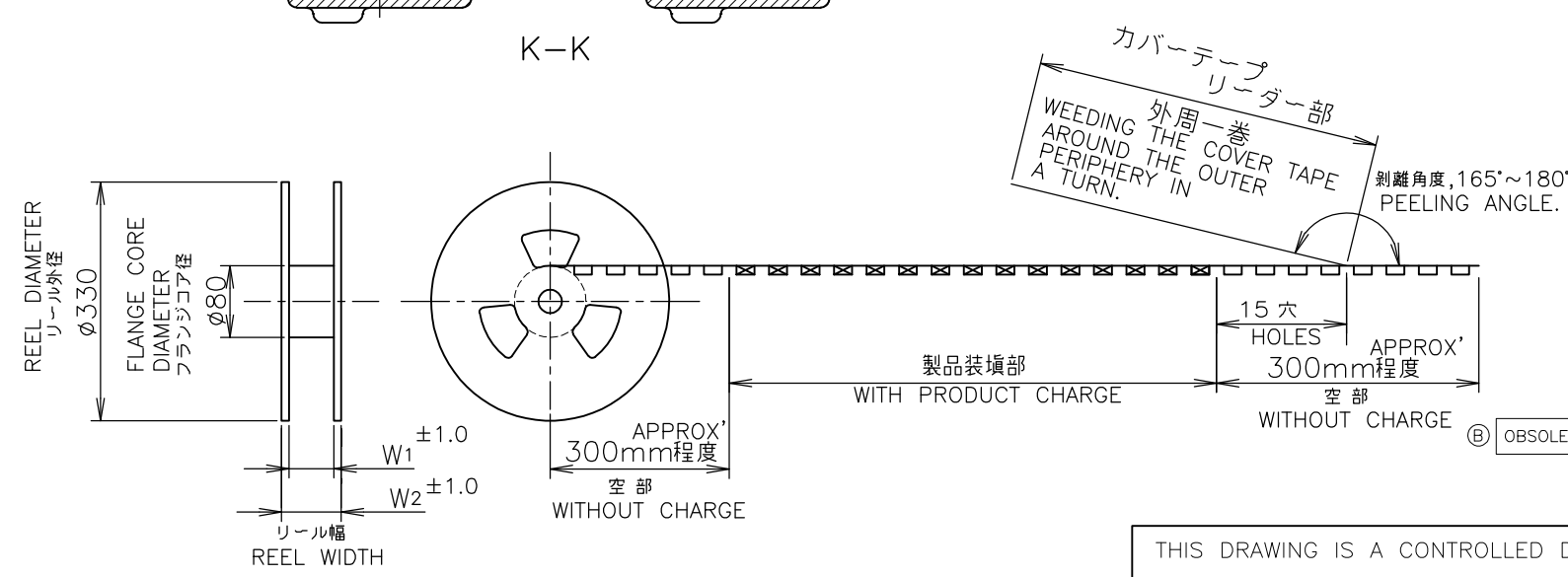

カバーテープ  
リーダー部  
外周一巻  
WEEDING AROUND THE COVER TAPE PERIPHERY IN A TURN.  
剥離角度, 165°~180°  
PEELING ANGLE.

| COLOR   | W2   | W1   | E    | D    | C  | B    | A    | 数量 (ヶ)<br>QTY/REEL | 極数<br>POS | リール巻<br>コネクタ型番<br>TAPING P/N |
|---------|------|------|------|------|----|------|------|--------------------|-----------|------------------------------|
| NATURAL | 48.7 | 45.5 | 0.4  | 28.4 | 44 | 40.4 | 20.2 | 1000               | 60        | 6-5917408-0                  |
| NATURAL | 29.5 | 25.5 | 0.38 | 13.2 | 24 | 11.5 | 11.5 | 1000               | 22        | 2-5917408-2                  |
| BLACK   | 22   | 18   | 0.5  | 8.4  | 16 | 7.5  | 7.5  | 1000               | 10        | 1-5917408-0                  |

THIS DRAWING IS A CONTROLLED DOCUMENT.

DWN: M.IWASAKI 27DEC04  
 CHK: Y.NAKAZAWA 27DEC04  
 APVD: T.KUSUHARA 27DEC04

Tyco Electronics  
 Tyco Electronics AMP K.K.  
 Kawasaki, Japan

ON TAPING EMBOSS  
 0.8mm PITCH B-TO-B CONN  
 RECEPTACLE ASSEMBLY WITH KEY & BOSS

SIZE: A3 CAGE CODE: 00779 DRAWING NO: G-5917408 RESTRICTED TO: -

CUSTOMER DRAWING SCALE: 4:1 SHEET: 1 OF 2 REV: B

GENERAL TOLERANCE  
一般公差

10 ≥ : ±0.2  
 30 ≥ > 10: ±0.25  
 100 ≥ > 30: ±0.3  
 ANGLES: ±3°

| DIMENSIONS:<br>単位: 耗<br>mm | TOLERANCES UNLESS<br>OTHERWISE SPECIFIED:<br>一般公差 |
|----------------------------|---|
| 0 PLC                      | ±   |
| 1 PLC                      | ±   |
| 2 PLC                      | ±   |
| 3 PLC                      | ±   |
| 4 PLC                      | ±   |
| ANGLES                     | ±   |
| FINISH<br>仕上               |   |

THIS DRAWING IS UNPUBLISHED. RELEASED FOR PUBLICATION DEC. 2004.  
 © COPYRIGHT 2004 BY TYCO ELECTRONICS CORPORATION. ALL RIGHTS RESERVED.

| LOC | DIST | REVISIONS   |      |     |
|-----|------|-------------|------|-----|
| J   |      | 変更          | DATE | DWN |
| P   | LTR  | DESCRIPTION | APVD |     |
|     |      | SEE SHEET 1 | -    | -   |

本図：コネクタ図  
 AS SHOWN: CONNECTOR DWG

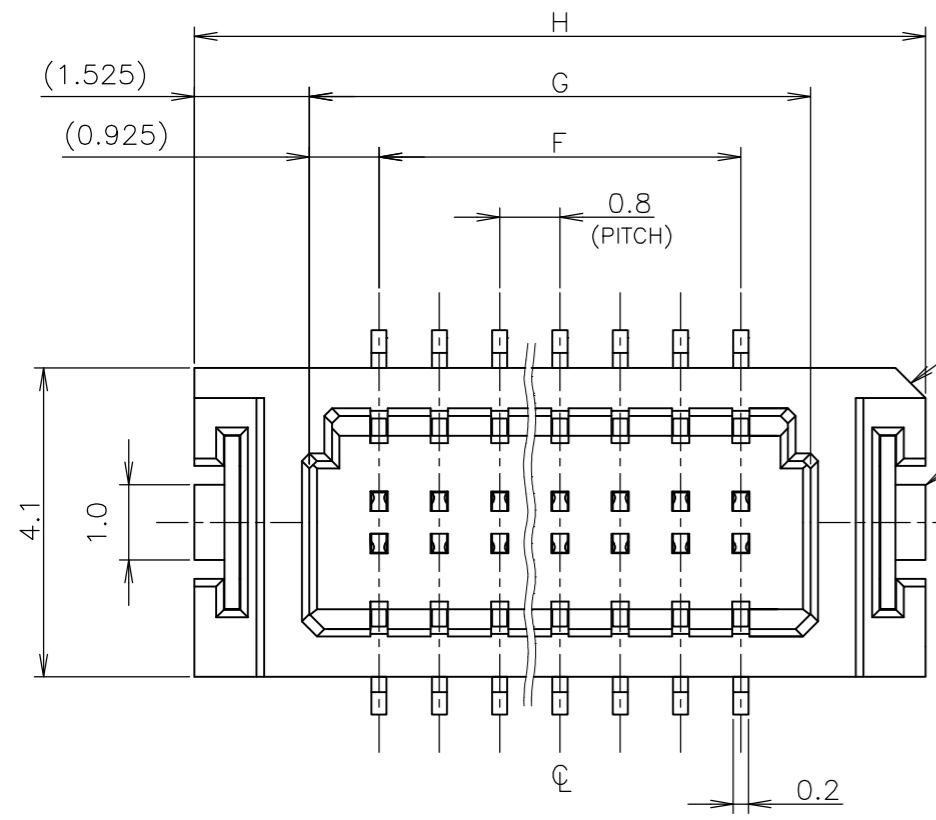

リセプタクルハウジング  
 RECEPTACLE HOUSING

回路番号1側  
 CIRCUIT NO.1 SIDE

テールプレート  
 TAIL PLATE

リセプタクルコンタクト  
 RECEPTACLE CONTACT

2.1

L-L

コネクタ位置  
 CONN. POSITION

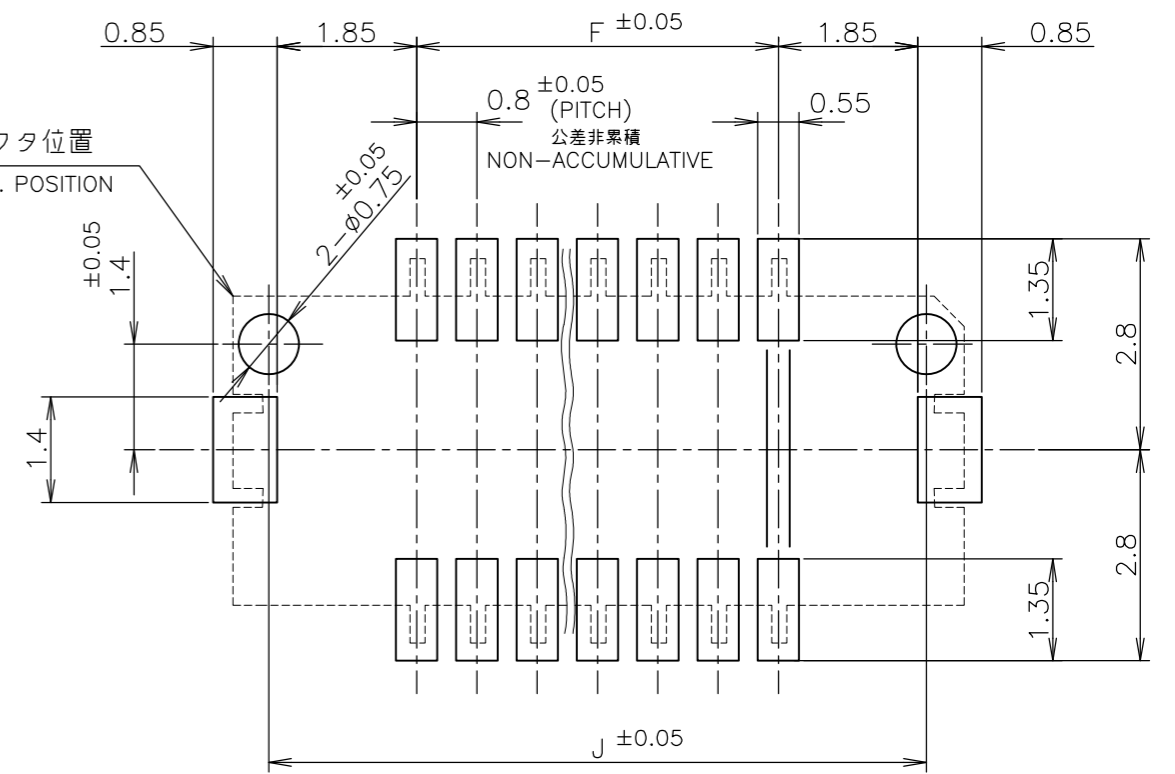

参考基板加工寸法  
 REFERENCE P.C. BOARD LAYOUT

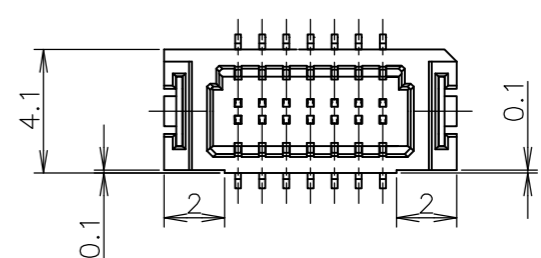

SCALE 4:1  
 AS SHOWN: 1-5917408-0 ONLY

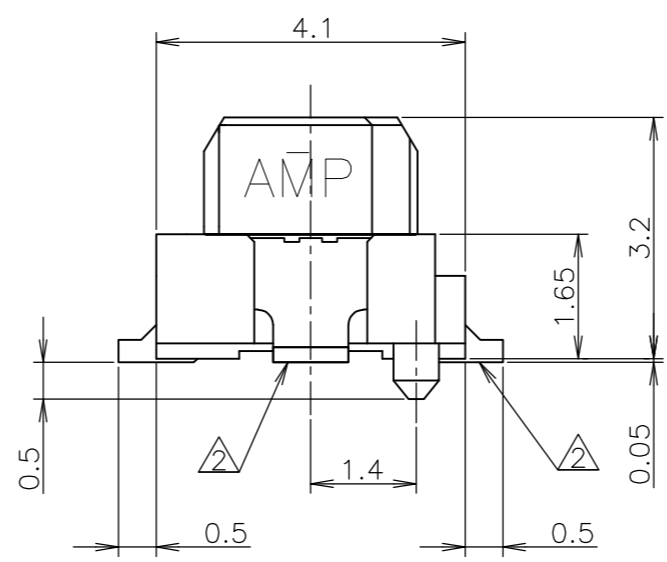
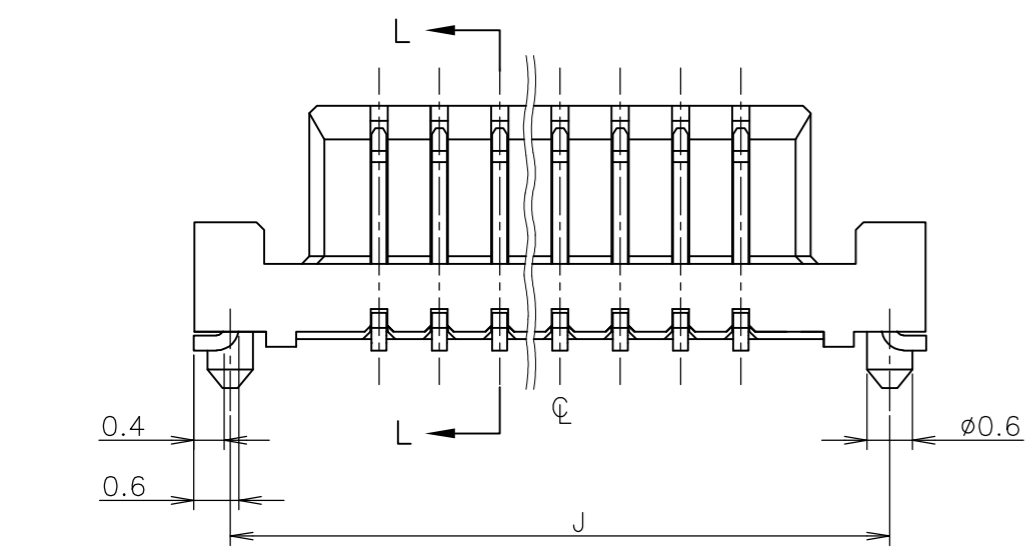

1 材料：リセプタクルハウジング：46ナイロン  
 (耐熱性樹脂)  
 リセプタクルコンタクト：銅合金 (t=0.2mm)  
 金めっき  
 テールプレート：銅合金 (t=0.2mm)  
 錫めっき

△ 全てのタイン部及びテールプレートのバラツキは 0.1mm MAX.

1 MATERIAL  
 REC HOUSING: 46 NYLON (HIGH HEAT-RESISTED RESIN)  
 REC CONTACT: COPPER-ALLOY (t=0.2mm)  
 Au PLATING  
 TAIL PLATE: COPPER-ALLOY (t=0.2mm)  
 TIN PLATING

△ MISALIGNMENT BETWEEN TAINS AND TAIL PLATE: 0.1mm MAX.

| GENERAL TOLERANCE<br>一般公差 |       |
|---------------------------|-------|
| 10 ≥                      | ±0.2  |
| 30 ≥ > 10                 | ±0.25 |
| 100 ≥ > 30                | ±0.3  |
| ANGLES                    | ±3°   |

|  |   |
|--|---|
| THIS DRAWING IS A CONTROLLED DOCUMENT. |   |
| DIMENSIONS:<br>単位：mm                   | TOLERANCES UNLESS<br>OTHERWISE SPECIFIED:<br>一般公差 |
|  | 0 PLC ±   |
|  | 1 PLC ±   |
|  | 2 PLC ±   |
|  | 3 PLC ±   |
| 4 PLC ±                                | ANGLES ±  |
| MATERIAL<br>材料                         | FINISH<br>仕上                                      |

|                            |          |
|----------------------------|----------|
| INSTRUCTION SHEET<br>取扱説明書 | 411-5808 |
| DWN                        |          |
| CHK                        |          |
| APVD                       |          |
| PRODUCT SPEC<br>製品規格       | 108-5512 |
| APPLICATION SPEC<br>取付適用規格 |          |
| WEIGHT                     |          |
| CUSTOMER DRAWING           |          |

|       |      |       |      |           |             |
|-------|------|-------|------|-----------|-------------|
| 27.15 | 28.1 | 25.05 | 23.2 | 60        | 6-5917408-0 |
| 11.95 | 12.9 | 9.85  | 8.0  | 22        | 2-5917408-2 |
| 7.15  | 8.1  | 5.05  | 3.2  | 10        | 1-5917408-0 |
| J     | H    | G     | F    | 極数<br>POS | 型番 PART NO  |

**Tyco Electronics** Tyco Electronics AMP K.K.  
 Kawasaki, Japan

ON TAPING EMBOSS  
 0.8mm PITCH B-TO-B CONN  
 RECEPTACLE ASSEMBLY WITH KEY & BOSS

|      |           |                  |               |
|------|-----------|------------------|---------------|
| SIZE | CAGE CODE | DRAWING NO<br>番号 | RESTRICTED TO |
| A3   | 00779     | 5917408          | -             |

SCALE 10:1 SHEET 2 OF 2 REV B