

# BRIGHT LED ELECTRONICS CORP.

●Device Number : BPT-BP2931

Page: 2

●Absolute Maximum Rating(Ta=25°C)

Version:1.2

Item	Symbol	Rating	Unit
Power Dissipation	Pd	100	mW
Collector-Emitter Voltage	V <sub>CEO</sub>	30	V
Emitter-Collector Voltage	V <sub>ECO</sub>	5	V
Operating Temperature	Topr	-45~+85	°C
Storage Temperature	Tstg	-45~+100	°C
Soldering Temperature(*1)	Tsol	250	°C

(\*1)、For 5 Sec

●Electrical And Optical Characteristics(Ta=25°C)

Parameter	Symbol	Test Condition	Min.	Typ.	Max.	Unit
Collector-Emitter Saturation Voltage	V <sub>CE(sat)</sub>	I <sub>c</sub> =0.5mA, E <sub>e</sub> =0.5mW/cm <sup>2</sup>	—	—	0.5	V
Collector-Emitter Breakdown Voltage	V <sub>(BR)CEO</sub>	I <sub>c</sub> =1mA, E <sub>e</sub> =0mW/cm <sup>2</sup>	30	—	—	V
Emitter-collector Breakdown Voltage	V <sub>(BR)ECO</sub>	I <sub>e</sub> =100μA, E <sub>e</sub> =0mW/cm <sup>2</sup>	5	—	—	V
Light Current	I <sub>c(on)</sub>	V <sub>ce</sub> =5V, E <sub>e</sub> =0.5mW/cm <sup>2</sup>	0.3	0.65	—	mA
Dark Current	I <sub>d</sub>	V <sub>ce</sub> =10V, E <sub>e</sub> =0mW/cm <sup>2</sup>	—	—	100	nA
Rise Time	Tr	F=100Hz, V <sub>ce</sub> =5V, R <sub>i</sub> =1kΩ	—	10	—	μs
Fall Time	Tf		—	15	—	μs
Viewing Angle	2θ1/2	V <sub>ce</sub> =5V, E <sub>e</sub> =0.5mW/cm <sup>2</sup>	—	30	—	deg

# BRIGHT LED ELECTRONICS CORP.

●Device Number:BPT-BP2931

Page: 3

●Dimensions

Version:1.1

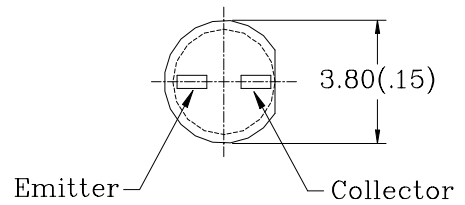
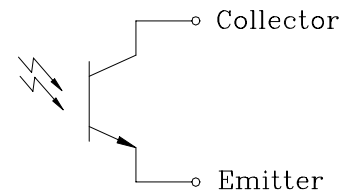
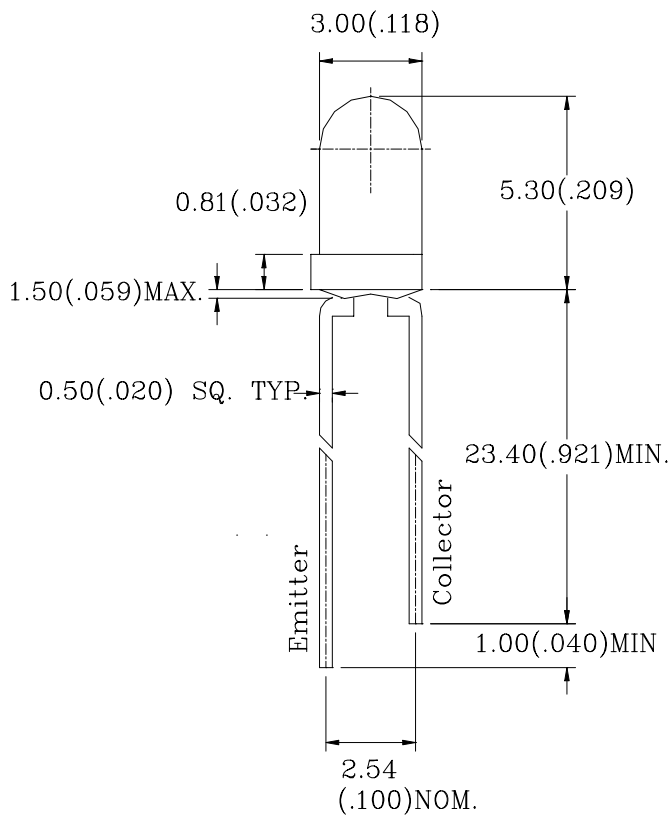

## Notes:

- 1、All dimensions are in millimeters(inches).
- 2、Tolerance is  $\pm 0.25\text{mm}(0.01'' )$  unless otherwise specified.
- 3、Lead spacing is measured where the leads emerge from the package.
- 4、Specifications are subject to change without notice.
- 5、Lens appearance: black.

# BRIGHT LED ELECTRONICS CORP.

●Device Number: BPT-BP2931

Page: 4

●Electrical And Optical Curves (Ta=25°C)

Version: 1.1

FIG.1 Dark Current Vs. Ambient Temperature

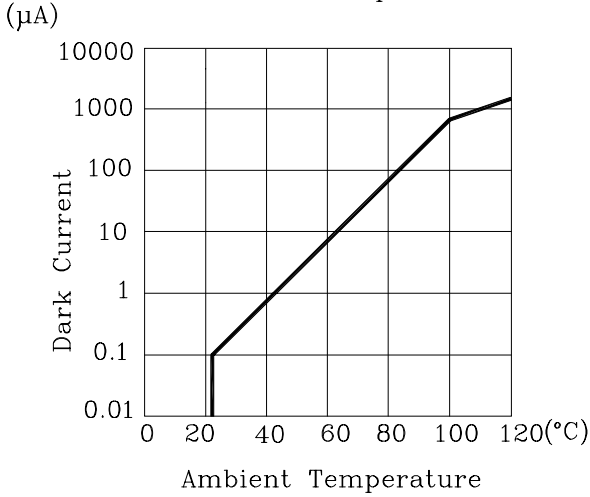

FIG.2 Power Dissipation Vs. Ambient Temperature

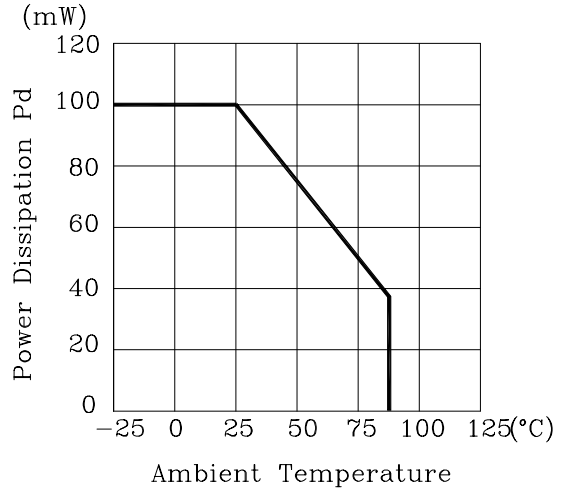

FIG.3 Rise And Fall Time Vs. Load Resistance

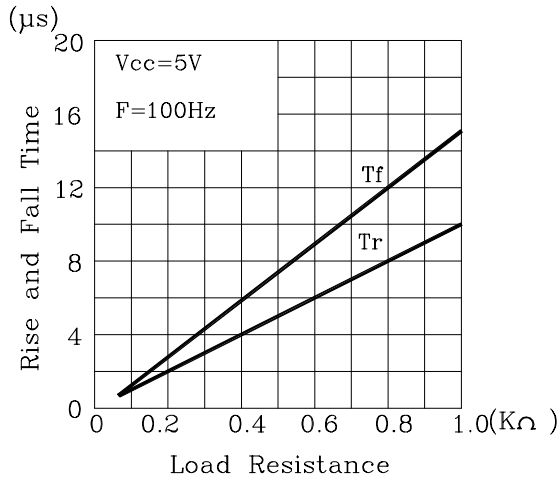

FIG.4 Relative Collector Current Vs. Irradiance

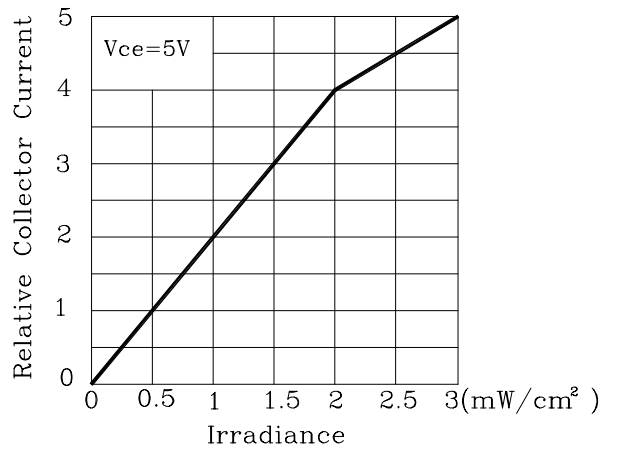

FIG.5 Radiant Diagram

