

Power Relay RM C/D

- 1 pole 30/32 A, 1 form X, double make, NO or 1 form Z, double make + double break, NO + NC
- Switching capacity up to 12800VA
- DC or AC coil
- Push-to-test button
- Chassis mount

Typical applications
Battery chargers, heating control.



Approvals

UL E214025, VDE Cert. No. 40003144 for AgNi-versions
Technical data of approved types on request.

Contact Data

	RMC	RMD
Contact arrangement	1 form Z, 1 NO + 1 NC	1 form X, 1 NO
Rated voltage	400VAC	
Max. switching voltage	440VAC	
Rated current	30A/32A (VDE)	
Limiting making current, max. 20ms	60A	
Switching power	7500VA	
Contact material	AgCdO, AgNi 90/10	
Contact style	single bridging contact	
Min. recommended contact load	24VDC/100mA	
Frequency of operation, with/without load, DC coil	960/6000h ⁻¹	
Operate/release time max., DC coil	20/20ms	
Bounce time max., form A/form B, DC coil	4/6ms	

Contact ratings

Type	Contact	Load	Cycles
EN 61810			
RMC/D	X of Z (NO), AgNi	32A, 400VAC res. 40°C	20x10 ³
RMC	Y of Z (NC), AgNi	32A, 400VAC res. 40°C	10x10 ³
RMC/D	X of Z (NO) AgNi DC coil	30A, 400VAC res. 50°C	10x10 ³
RMC/D	X of Z (NO) AgNi AC coil	30A, 400VAC res. 40°C	10x10 ³
UL 508			
RMC/D	X/Y (NO/NC), AgCdO,	30 A, 277 VAC, general purpose 50°C	10x10 ³
RMC/D	X/Y (NO/NC)	30 A, 415 VAC, resistive 50°C	10x10 ³
RMC/D	X (of Z / NO), AgNi	120 VAC, 0,75 HP 50°C	10x10 ³
RMC/D	X/Y (NO/NC)	240 VAC, 2 HP 50°C	6x10 ³
Mechanical endurance			
DC coil			10x10 ⁶ operations
AC coil			10x10 ⁶ operations

Coil Data

Coil voltage range	6 to 220 VDC 6 to 400 VAC
Operative range, IEC 61810	2
Coil insulation system according UL	class 130 (B)

Coil versions, DC coil

STD	LED bipolar	Coil code	LED+ PD ³⁾	Rated voltage VDC	Coil resistance Ω±10% ¹⁾²⁾	Rated coil power W
006	L06	0A6	LA6	6	32	1.1
012	L12	0B2	LB2	12	110	1.3
024	L24	0C4	LC4	24	475	1.2
048	L48	0E8	LE8	48	2000	1.2
060	L60	0G0	LG0	60	2850	1.3
110	M10	1B0	MB0	110	10000 ¹⁾	1.2
221	N21	2C1	NC1	220	40000 ²⁾	1.2

Operate voltage, DC coil 75% of rated coil voltage
Release voltage, DC coil 10% of rated coil voltage

1) Coil resistance ±12%, 2) Coil resistance ±15%.
3) Protection diode PD; standard polarity: +A1 / -A2.

All figures are given for coil without pre-energization, at ambient temperature +23°C.

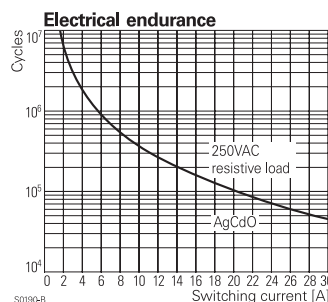
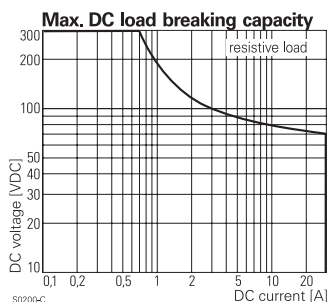
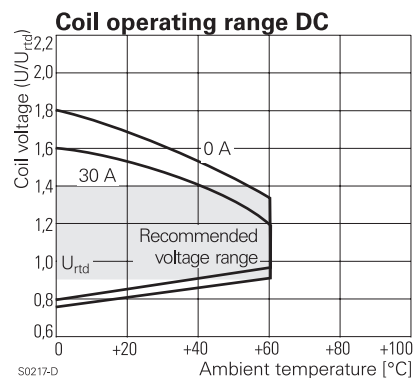

Power Relay RM C/D (Continued)

Coil Data (continued)

Coil versions, AC coil

Coil code	Rated voltage	Operate voltage	Release voltage	Coil resistance	Rated coil power
STD	LED	50/60Hz	50/60Hz	$\Omega \pm 10\%^{1)2)}$	50/60Hz
	VAC	VAC	VAC		VA

Coil versions, AC-coil, RMC, RMD

524	R24	24	19.2/20.4	7.2	80	2.62/2.00
548	R48	48	38.4/40.8	14.4	320	2.60/2.17
560	R60	60	48.0/51.0	18.0	500	2.62/2.20
615	S15	115	92.0/97.8	34.5	1850	2.65/2.22
730	T30	230	184.0/195.5	69.0	7500	2.69/ 2.26
900	V00	400	320.0/340.0	120.0	23500 ²⁾	2.61/2.20

2) Coil resistance $\pm 15\%$.

All figures are given for coil without pre-energization, at ambient temperature +23°C.

Insulation Data

	RMC	RMD
Initial dielectric strength		
between open contacts	1500Vrms	2000Vrms
between contact and coil	2500Vrms	2500Vrms
Initial surge withstand voltage		
between contact and coil	6000V (1.2/50 μ s)	
Clearance/creepage		
between contact and coil	$\geq 4.0/14.9$ mm	
Material group of insulation parts	IIIa	

Other Data

Material compliance: EU RoHS/ELV, China RoHS, REACH, Halogen content refer to the Product Compliance Support Center at www.te.com/customer-support/rohssupportcenter

Ambient temperature for mounting/handling in operation	-20 to +40°C
DC coil	-40 to +60°C
AC coil	-40 to +40°C
Cold storage, IEC 60068-2-1	Test Aa (-40°C/16h)
Dry heat, IEC 60068-2-2	Test B (+85°C/16h)
Damp heat cyclic, IEC 60068-2-30, Db, Variant 1	12/12h +25/55°C 2 cycles
Category of environmental protection IEC 61810	RT1 - dust protected
Vibration resistance (functional) form A (NO)/form B (NC)	10/5 g, 30 to 150Hz
Terminal type	quick connect (QC)
Cover retention	
pull force	100N
push force	100N
Weight	81g
Packaging unit	10 pcs.

Terminal assignment

Bottom view on pins

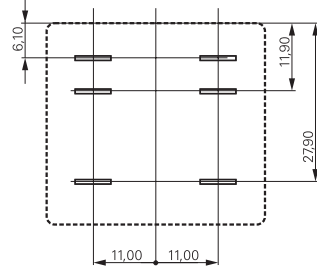

1 form Z contact (1 NO + 1 NC), RMC

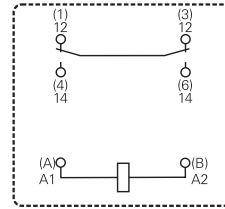

1 form X contact (1 NO), RMD

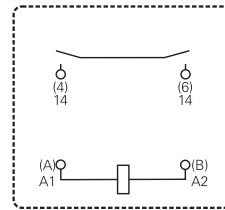

Dimensions

Dimensions in mm

Cover with mounting brackets, 6.3mm quick connect terminals

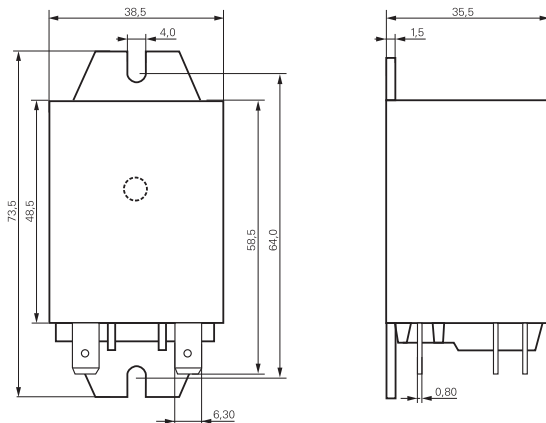

Power Relay RM C/D (Continued)

Product code structure

Typical product code **RM D 0 5 730**

Type	RM Power Relay RMC/D				
Contact arrangement	C 1 form Z (1 NO + 1 NC), 30A D 1 form X (1 NO), 30A				
Version	0 AgCdO, without test button 3 AgCdO, with test button 2 AgNi90/10, without test button 7 AgNi90/10, with test button				
Enclosure	5 Cover with mounting brackets, 6.3mm quick connect terminals				
Coil	Coil code: please refer to coil versions table				

Product key	Contacts	Version	Enclosure	Coil	Coil	Part number
RMC05024	1 form Z,	Without	Mounting brackets quick c. 6.3 mm	DC coil	24VDC	4-1393844-5
RMC05524	1 NO + 1 NC	test button		AC coil	24VAC	1393146-5
RMC05615	contact				115VAC	8-1393147-7
RMC05730	30A				230VAC	1393146-6
RMC35024		With test button		DC coil	24VDC	1393146-7
RMD05024	1 form X,	Without			24VDC	1393146-9
RMD05524	1 NO contact	test button		AC coil	24VAC	1-1393146-1
RMD05615	30A				115VAC	1415009-1
RMD05730					230VAC	4-1393844-7
RMD35024		With		DC coil	24VDC	2-1419136-2
RMD35730		test button		AC coil	230VAC	1393097-5