

Technical Data Sheet

Photo coupler-RoHS Compliant

EL816 Series

Features:

- Current transfer ratio
(CTR:MIN.50% at $I_F = 5\text{mA}$, $V_{CE} = 5\text{V}$)
- High isolation voltage between input and output ($V_{iso} = 5000\text{Vrms}$)
- Compact dual-in-line package
EL816:1-channel type
- Pb free
- UL approved (No. E214129)
- VDE approved (No. 132249)
- SEMKO approved (No. 608400)
- NEMKO approved (No. PO6206474/A1)
- DEMKO approved (No. 313924-01)
- FIMKO approved (No. FI 22807A1)
- CSA approved (No. 1143601)
- BSI approved (No. 8592 / 8593)
- Options available:
 - Leads with 0.4"(10.16mm) spacing (M Type)
 - Leads bends for surface mounting (S、S1 Type)
 - Tape and Reel of Type I for SMD(Add"-TA" Suffix)
 - Tape and Reel of Type II for SMD(Add"-TB" Suffix)
 - The tape is 16mm and is wound on a 33cm reel

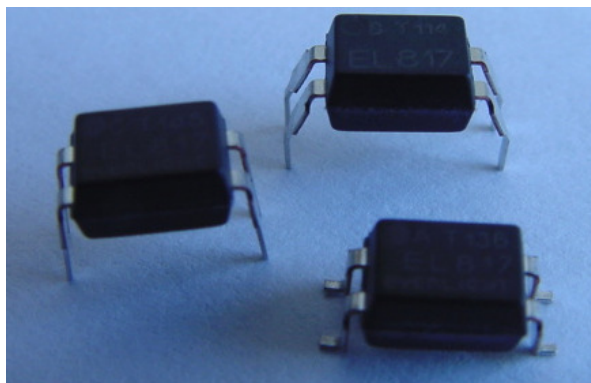

Description

The EL816 series contains an infrared emitting diode optically coupled to a phototransistor. It is packaged in a 4-pin DIP package and available in wide-lead spacing and SMD option.

Applications

- Computer terminals
- System appliances, measuring instruments
- Registers, copiers, automatic vending machines
- Cassette type recorder
- Electric home appliances, such as fan heaters, etc.
- Signal transmission between circuits of different potentials and impedances

Technical Data Sheet
Photo coupler-RoHS Compliant
EL816 Series
Device Selection Guide

Part No.	Chip Material	
	IR	PT
EL816	GaAs	Silicon

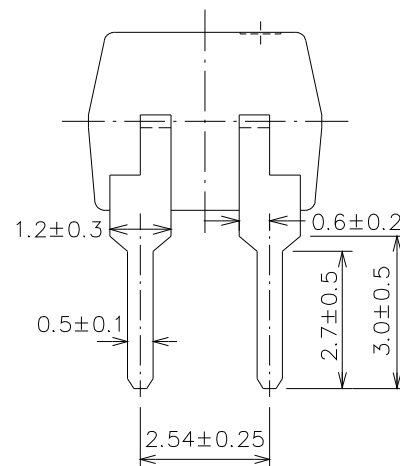
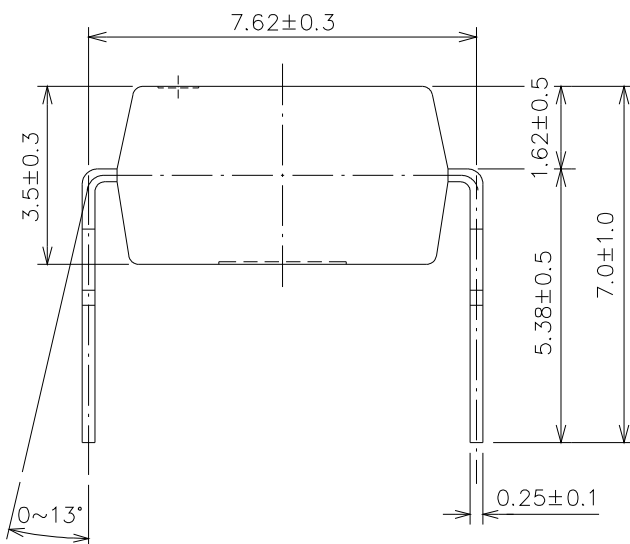
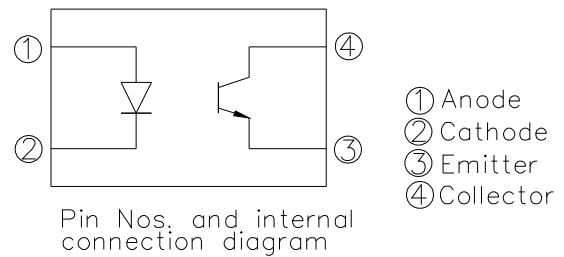
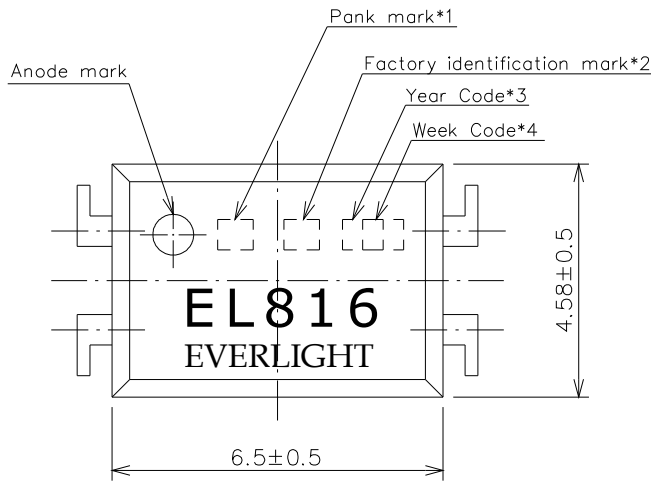
Package Dimensions

Technical Data Sheet
Photo coupler-RoHS Compliant

EL816 Series

Package Dimensions

M Type

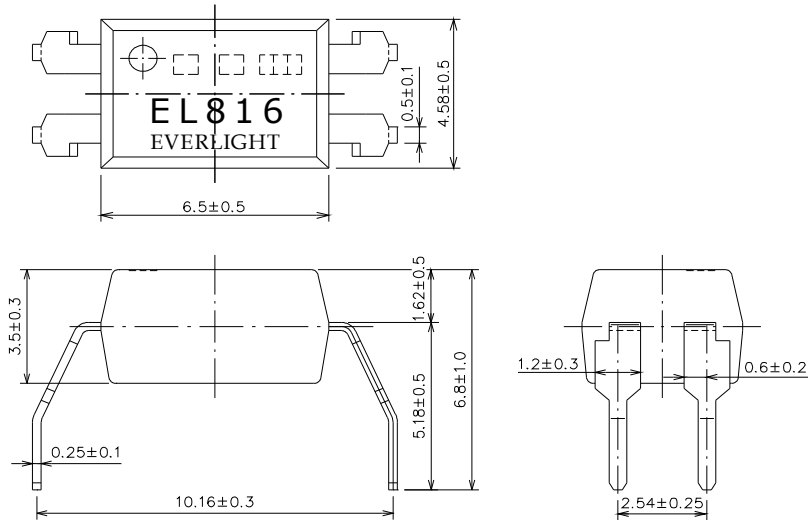

S Type

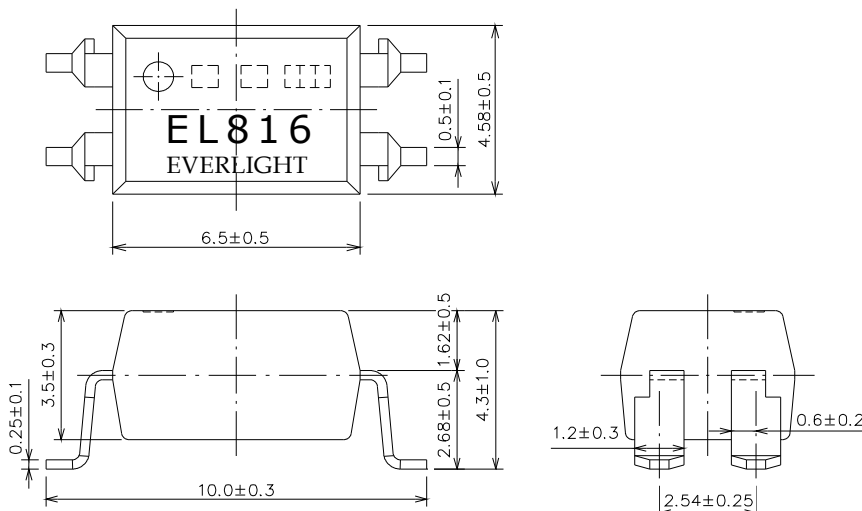

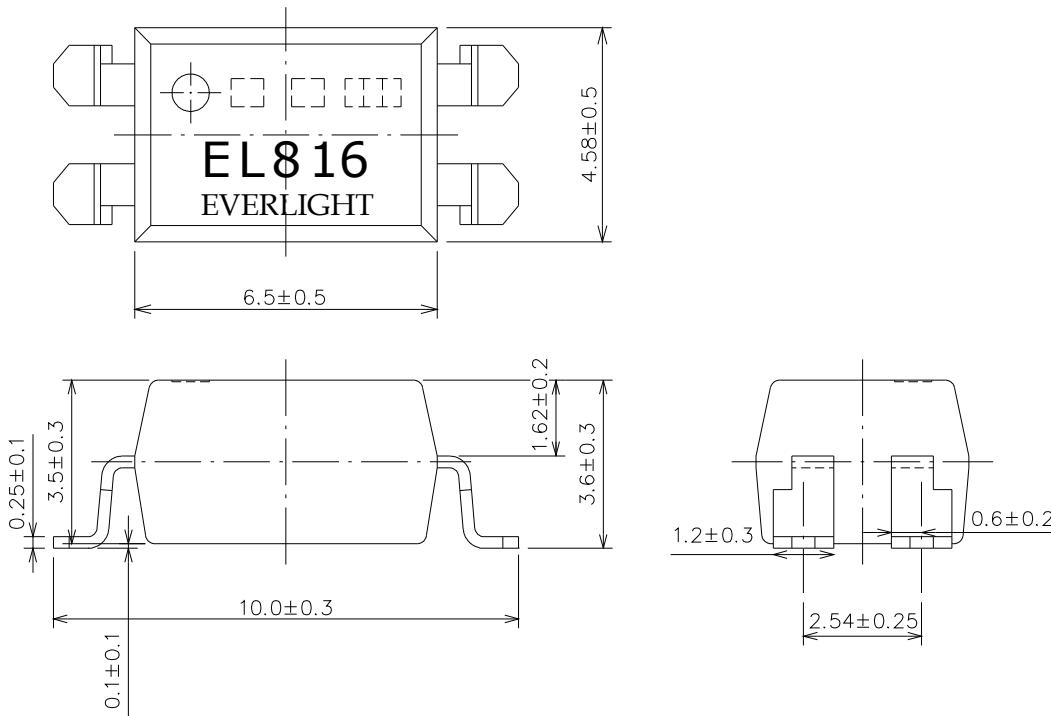
Technical Data Sheet
Photo coupler-RoHS Compliant
EL816 Series
S1 Type

Notes:

1. Rank shall be or shall not be marked
2. Factory code shall be marked
(T: Taiwan / C: China)
3. Year date code
4. 2-digit work week
5. All dimensions are in millimeters
6. Specifications are subject to change
7. without notice
8. External creepage ≥ 7.6 mm
External clearance ≥ 7.6 mm
9. Internal clearance ≥ 0.4 mm

Technical Data Sheet
Photo coupler-RoHS Compliant
EL816 Series
Absolute Maximum Ratings
(Ta=25°C)

Parameter		Symbol	Rating	Unit
Input	Forward Current	I_F	50	mA
	Reverse Voltage	V_R	6	V
	Power Dissipation	P	70	mW
Output	Collector Power Dissipation	P_C	150	mW
	Collector Current	I_C	50	mA
	Collector-Emitter Voltage	V_{CEO}	80	V
	Emitter-Collector Voltage	V_{ECO}	6	V
Total Power Dissipation		P_{tot}	200	mW
* ¹ Isolation Voltage		V_{iso}	5000	V_{rms}
Operating Temperature		T_{opr}	-50~+110	°C
Storage Temperature		T_{stg}	-55~+125	°C
* ² Soldering Temperature		T_{sol}	260	°C

*¹ AC for 1 minute, R.H.= 40 ~ 60% R.H.

-Isolation voltage shall be measured using the following method.

- (1) Short between anode and cathode on the primary side and between collector, emitter and base on the secondary side.
- (2) The isolation voltage tester with zero-cross circuit shall be used.
- (3) The waveform of applied voltage shall be a sine wave

*² For 10 seconds or 10 seconds

Technical Data Sheet
Photo coupler-RoHS Compliant
EL816 Series
Electro-Optical Characteristics
(Ta=25°C)

Parameter		Symbol	Min.	Typ.	Max.	Unit	Condition
Input	Forward Voltage	V_F	-	1.2	1.4	V	$I_F=20mA$
	Reverse Current	I_R	-	-	10	uA	$V_R=4V$
	Terminal Capacitance	C_t	-	30	250	pF	$V=0, f=1kHz$
Output	Collector Dark current	I_{CEO}	-	-	100	nA	$V_{CE}=20V$
	Collector-Emitter Breakdown Voltage	BV_{CEO}	80	-	-	V	$I_C=0.1mA$
Transfer Characteristics	Current Transfer Ratio	CTR	50	-	600	%	$I_F=5mA, V_{CE}=5V$
	Collector-Emitter Saturation Voltage	$V_{CE(sat)}$	-	0.1	0.2	V	$I_F=20mA, I_C=1mA$
	Isolation Resistance	R_{ISO}	5×10^{10}	10^{11}	-	Ω	DC500V, 40~60% R.H.
	Floating Capacitance	C_f	-	0.6	1.0	pF	$V=0, f=1MHz$
	Cut-off Frequency	f_c	-	80	-	kHz	$V_{CE}=5V, I_C=2mA$ $R_L=100\Omega, -3dB$
	Rise time	t_r	-	4	18	μs	$V_{CE}=2V$ $I_C=2mA, R_L=100\Omega$
	Fall time	t_f	-	3	18	μs	

Technical Data Sheet
Photo coupler-RoHS Compliant
EL816 Series
Supplement
Rank Table of Current Transfer Ratio CTR

Model No.	Rank mark	CTR (%)	Condition
EL816	---	50 to 600	$I_F = 5 \text{ mA}$ $V_{CE} = 5 \text{ V}$ $T_a = 25^\circ\text{C}$
EL816(A)	A	50 to 160	
EL816(B)	B	130 to 260	
EL816(C)	C	200 to 400	
EL816(D)	D	300 to 600	
EL816(X)	X	100 to 200	
EL816(Y)	Y	150 to 300	

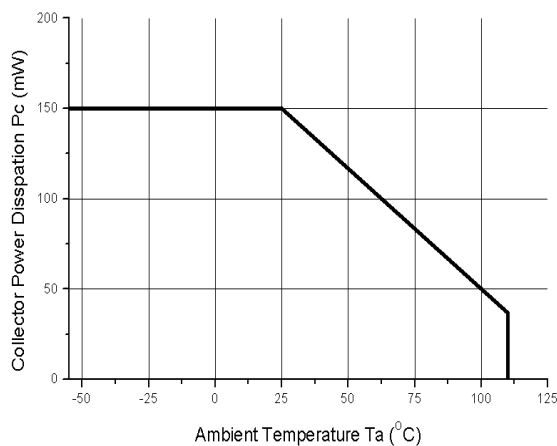
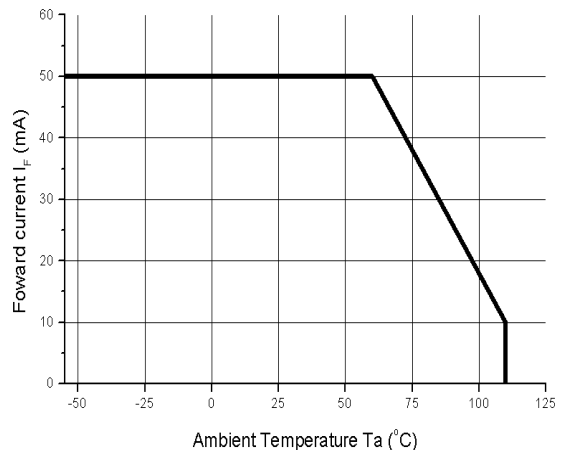
FIG.1 Forward current vs.Ambient Temperature

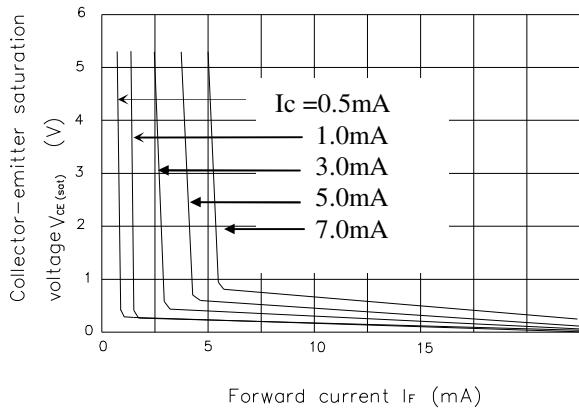
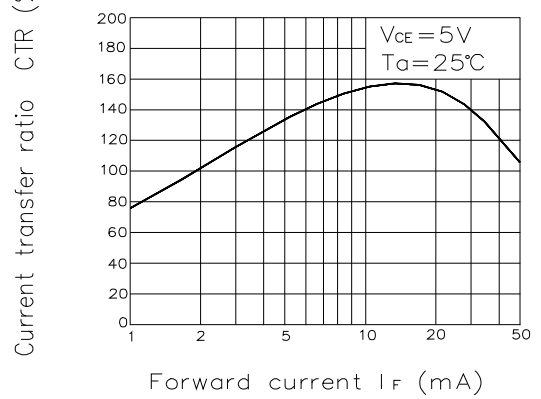
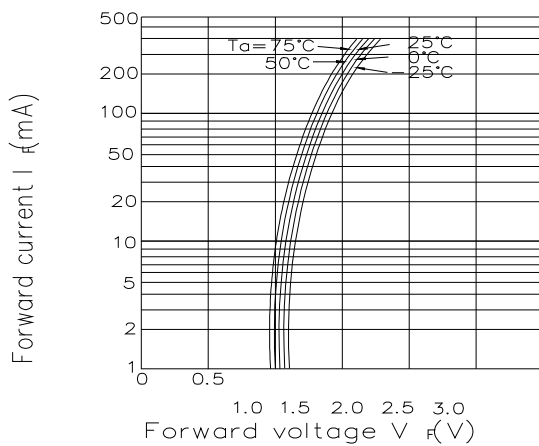
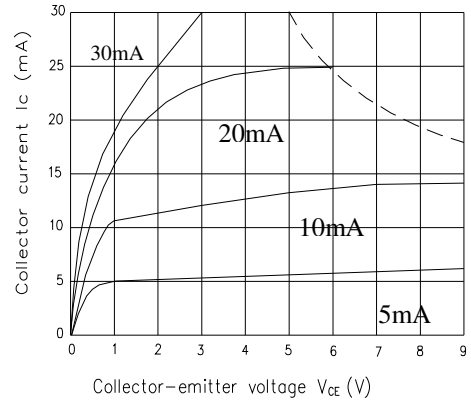
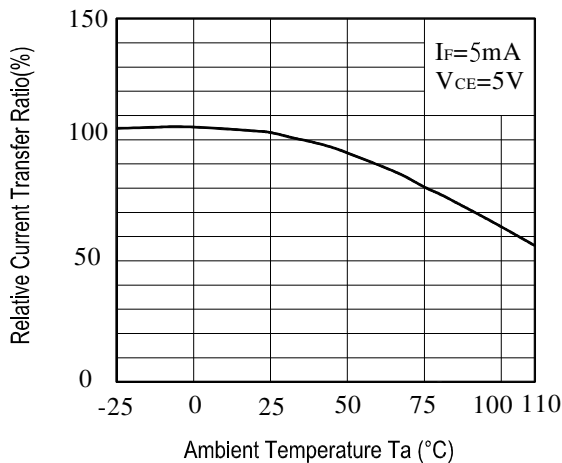
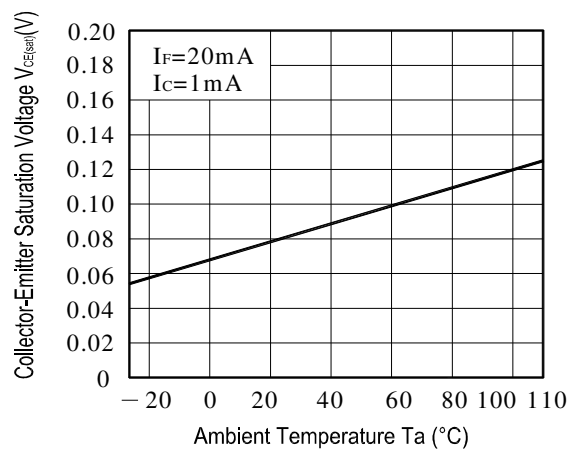
Fig.2 Collector Power Dissipation vs. Ambient Temperature

Technical Data Sheet
Photo coupler-RoHS Compliant
EL816 Series
Fig. 3 Collector-emitter Saturation Voltage vs. Forward Current ($T_a=25^\circ\text{C}$)

Fig.4 Current transfer Ratio vs. Forward Current

Fig.5 Forward Current vs. Forward Voltage

Fig.6 Collector Current vs. Collector-emitter Voltage ($T_a=25^\circ\text{C}$)

Fig.7 Relative Current Transfer Ratio vs. Ambient Temperature

Fig.8 Collector-Emitter Saturation Voltage vs. Ambient Temperature

Technical Data Sheet
Photo coupler-RoHS Compliant

EL816 Series

Fig.9 Collector Dark Current vs. Ambient Temperature

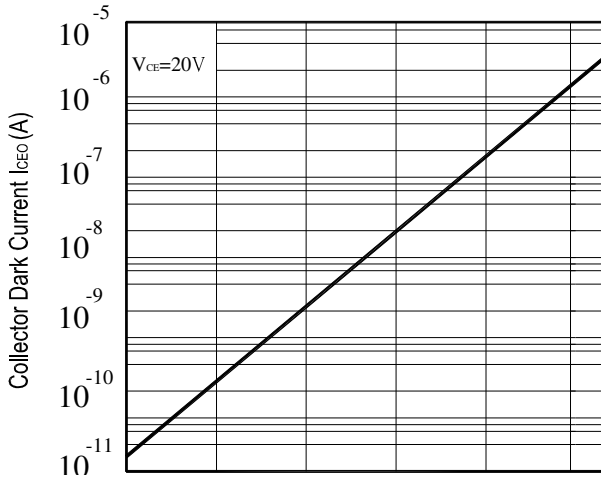

Fig.10 Response Time vs. Load Resistance

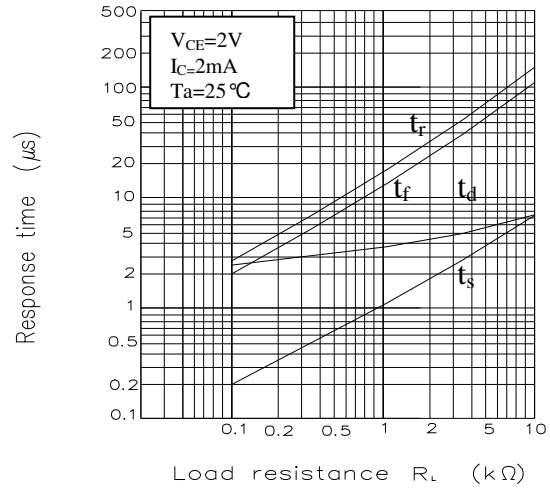
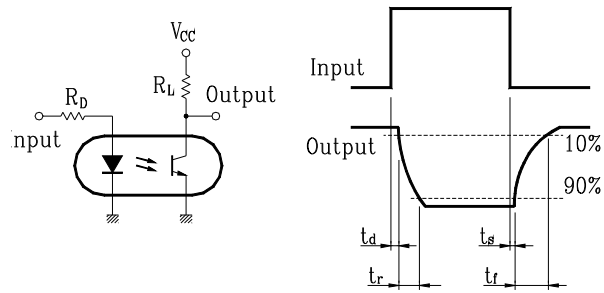
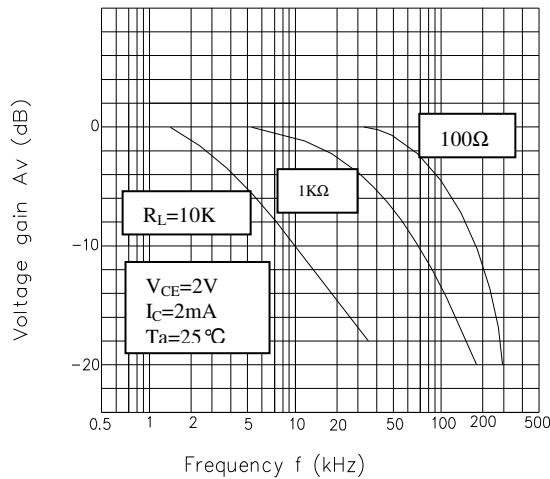

Fig.11 Frequency Response





Technical Data Sheet

Photo coupler-RoHS Compliant

EL816 Series**RELIABILITY PLAN**

- The reliability of products shall be satisfied with items listed below.
- Confidence level : 90 % , LTPD : 10 %

Classification	Test Item	Description & Condition	(Acc.) Sample	Failure Criteria	Reference Standard
Endurance test	Operation Life *	Ta = 25 ± 3°C IR: If = 50 mA Pt: Pc = 130 mW (Vf=1.4v) , 1000 hrs	0 / 22	CTR shift > 1.2 Vf > U* 1.0 Ir > U * 1.0 Vce(sat) > U*1.0 Bvceo < L*1.0 Bveco < L*1.0 L :Low Spec.Limit U : Up Spec.	MIL-S-750 : 1026 MIL-S-883 : 1005 JIS C 7021 : B-1
	High Temperature / High Humidity Reverse Bias (H3TRB)	Ta = 85 ± 3°C , Humi. = 85 % rh Pt: 80% * Vce (max rating) , 1000 hrs	0 / 22		JIS C 7021 : B-11
	High Temperature Reverse Bias (HTRB)	Ta = 105 ± 3°C Pt: 100% * Vce (Max rating) , 1000 hrs	0 / 22		JIS C 7021 : B-8
	Low Temperature Storage	Ta = -50 ± 3°C , 1000 hrs	0 / 22		JIS C 7021 : B-12
	High Temperature Storage	Ta = 125 ± 3°C , 1000 hrs	0 / 22		JIS C 7021 : B-10 MIL-S-883 : 1008
	Autoclave	P = 15 PSIG , Ta = 121 °C , Humi. = 100 % rh , 48 hrs	0 / 22		JESD 22-A102-B
Environmental Test	Temperature Cycling (Air to Air)	125°C ~ -55 °C 30 ~ 30 min , 100 cycles	0 / 22	Limit	MIL-S-883 :1010 JIS C 7021 : A-4
	Thermal Shock (Liquid to Liquid)	125 ~ -55°C t (dwell) = 5 min t (trans.) = 10 sec , 100 cycles	0 / 22		MIL-S-202 : 107D MIL-S-750 : 1051 MIL-S-883 :1011
	Solder Resistance	Ta = 260 ± 3°C t (dwell) = 10 ± 1 sec	0 / 22		MIL-S-750 : 2031 JIS C 7021 : A-1
	Solder Ability	Ta = 230 ± 3 °C t (dwell) = 5 ± 1 sec	0 / 22		MIL-S-883 : 2003 JIS C 7021 : A-2

Technical Data Sheet
Photo coupler-RoHS Compliant

EL816 Series

1. Tube Packing Specifications (For Dip & M,S Type)

1. Tube

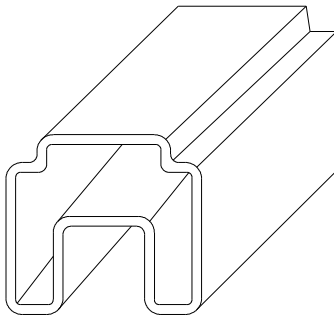

2.Inner Carton

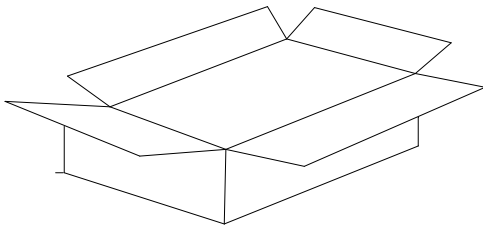

3.Outside Carton

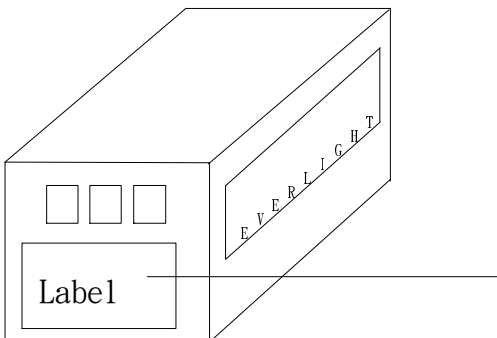

EVERLIGHT

CPN:

P/N:



EL816

QTY:



CAT:

HUE:

REF:

LOT NO:



MADE IN TAIWAN

CPN: Customer's Production Number

P/N : Production Number

QTY: Packing Quantity

CAT: Ranks

HUE: Peak Wavelength

REF: Reference

LOT No: Lot Number

MADE IN TAIWAN: Production Place

● Packing Quantity

- 1. 100 Pcs/ Per Tube
- 2. 25 Tubes / Inner Carton
- 3. 12 Inner Cartons / Outside Carton

Technical Data Sheet
Photo coupler-RoHS Compliant

EL816 Series

2. Tape & Reel Packing Specifications

1. Tape & Reel (For S Type)

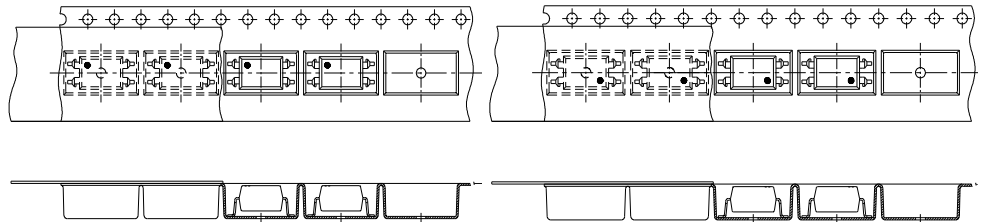
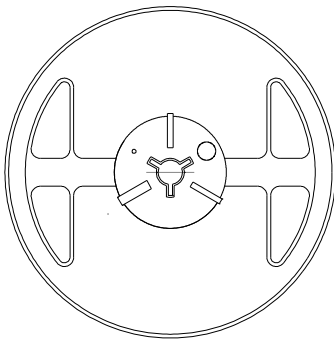

TA

TB



2. Inner Carton

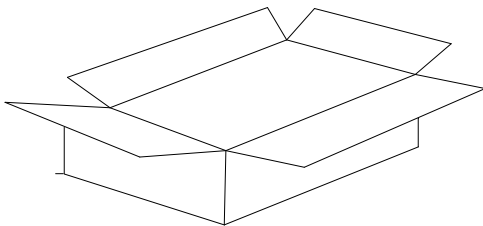

CPN:

P/N:



EL816

QTY:



CAT:

HUE:

REF:

LOT NO:

3. Outside Carton

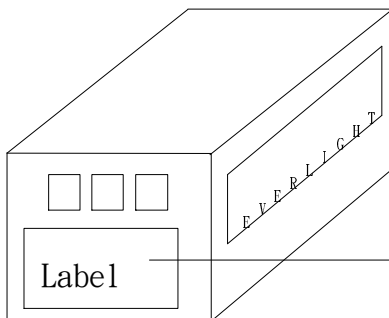

MADE IN TAIWAN

CPN: Customer's Production Number

P/N : Production Number

QTY: Packing Quantity

CAT: Ranks

HUE: Peak Wavelength

REF: Reference

LOT No: Lot Number

MADE IN TAIWAN: Production Place



Technical Data Sheet
Photo coupler-RoHS Compliant

EL816 Series

Packing Quantity

1. 1,000 Pcs/ Per Reel
2. 3 Reels / Inner Carton
3. 10 Inner Cartons / Outside Carton

Notes

1. Above specification may be changed without notice. EVERLIGHT will reserve authority on material change for above specification.
2. When using this product, please observe the absolute maximum ratings and the instructions for using outlined in these specification sheets. EVERLIGHT assumes no responsibility for any damage resulting from use of the product which does not comply with the absolute maximum ratings and the instructions included in these specification sheets.
3. These specification sheets include materials protected under copyright of EVERLIGHT Corporation. Please don't reproduce or cause anyone to reproduce them without EVERLIGHT's consent.

EVERLIGHT ELECTRONICS CO., LTD.

*Office: No 25, Lane 76, Sec 3, Chung Yang Rd,
Tucheng, Taipei 236, Taiwan, R.O.C*

Tel: 886-2-2267-2000, 2267-9936

Fax: 886-2267-6244, 2267-6189, 2267-6306

http://www.everlight.com