

## Dimensions SOD-323

### 200 mW SOD-323 Surface Mount

- We declare that the material of product compliance with RoHS requirements.

#### ORDERING INFORMATION

Device*	Package	Shipping
LM3ZxxxT1G	SOD-323	3000/Tape&Reel
LM3ZxxxT3G	SOD-323	10000/Tape&Reel

This series of Zener diodes is packaged in a SOD-323 surface mount package that has a power dissipation of 200 mW. They are designed to provide voltage regulation protection and are especially attractive in situations where space is at a premium. They are well suited for applications such as cellular phones, hand held portables, and high density PC boards.

#### Specification Features:

- Standard Zener Breakdown Voltage Range – 2.4 V to 75 V
- Steady State Power Rating of 200 mW
- Small Body Outline Dimensions: 0.067" x 0.049" (1.7 mm x 1.25 mm)
- Low Body Height: 0.035" (0.9 mm)
- Package Weight: 4.507 mg/unit
- ESD Rating of Class 3 (>16 kV) per Human Body Model
- Pb-Free package is available.

#### Mechanical Characteristics:

**CASE:** Void-free, transfer-molded plastic

**FINISH:** All external surfaces are corrosion resistant

#### MAXIMUM CASE TEMPERATURE FOR SOLDERING PURPOSES:

260°C for 10 Seconds

**POLARITY:** Cathode indicated by polarity band

**FLAMMABILITY RATING:** UL94 V-0

**MOUNTING POSITION:** Any

#### MAXIMUM RATINGS

Rating	Symbol	Max	Unit
Total Device Dissipation FR-5 Board, (Note 1.) @ TA = 25°C Derate above 25°C	$P_D$	200	mW
Thermal Resistance from Junction to Ambient	$R_{\theta JA}$	635	°C/W
Junction and Storage Temperature Range	$T_J, T_{stg}$	-65 to+150	°C

1. FR-4 Minimum Pad



### Pin Configuration

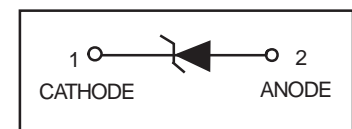

## ELECTRICAL CHARACTERISTICS

( $T_A = 25^\circ\text{C}$  unless otherwise noted,  
 $V_F = 0.9\text{ V Max. @ } I_F = 10\text{ mA}$  for all types)

Symbol	Parameter
$V_Z$	Reverse Zener Voltage @ $I_{ZT}$
$I_{ZT}$	Reverse Current
$Z_{ZT}$	Maximum Zener Impedance @ $I_{ZT}$
$I_{ZK}$	Reverse Current
$Z_{ZK}$	Maximum Zener Impedance @ $I_{ZK}$
$I_R$	Reverse Leakage Current @ $V_R$
$V_R$	Reverse Voltage
$I_F$	Forward Current
$V_F$	Forward Voltage @ $I_F$
$\Theta V_Z$	Maximum Temperature Coefficient of $V_Z$
C	Max. Capacitance @ $V_R = 0$ and $f = 1\text{ MHz}$

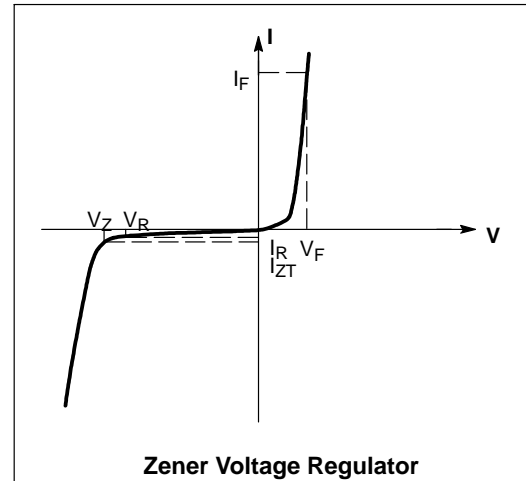

**ELECTRICAL CHARACTERISTICS** ( $T_A = 25^\circ\text{C}$  unless otherwise noted,  $V_F = 0.9\text{ V Max.}$  @  $I_F = 10\text{ mA}$  for all types)

Device	Device Marking	Zener Voltage (Note 2.)			Zener Impedance			Leakage Current		$\theta_{VZ}$ (mV/k) @ $I_{ZT}$		C @ $V_R = 0$ f = 1 MHz pF	
		$V_Z$ (Volts)			$Z_{ZT}$ @ $I_{ZT}$	$Z_{ZK}$ @ $I_{ZK}$		$I_R$ @ $V_R$		Min	Max		
		Min	Nom	Max	mA	$\Omega$	$\Omega$	mA	$\mu\text{A}$	Volts	Min		Max
LM3Z2V4T1G	00	2.2	2.4	2.6	5	100	1000	0.5	50	1.0	-3.5	0	450
LM3Z2V7T1G	01	2.5	2.7	2.9	5	100	1000	0.5	20	1.0	-3.5	0	450
LM3Z3V0T1G	02	2.8	3.0	3.2	5	100	1000	0.5	10	1.0	-3.5	0	450
LM3Z3V3T1G	05	3.1	3.3	3.5	5	95	1000	0.5	5	1.0	-3.5	0	450
LM3Z3V6T1G	06	3.4	3.6	3.8	5	90	1000	0.5	5	1.0	-3.5	0	450
LM3Z3V9T1G	07	3.7	3.9	4.1	5	90	1000	0.5	3	1.0	-3.5	-2.5	450
LM3Z4V3T1G	08	4.0	4.3	4.6	5	90	1000	0.5	3	1.0	-3.5	0	450
LM3Z4V7T1G	09	4.4	4.7	5.0	5	80	800	0.5	3	2.0	-3.5	0.2	260
LM3Z5V1T1G	0A	4.8	5.1	5.4	5	60	800	0.5	2	2.0	-2.7	1.2	225
LM3Z5V6T1G	0C	5.2	5.6	6.0	5	40	700	0.5	1	2.0	-2.0	2.5	200
LM3Z6V2T1G	0E	5.8	6.2	6.6	5	10	100	0.5	3	4.0	0.4	3.7	185
LM3Z6V8T1G	0F	6.4	6.8	7.2	5	15	160	0.5	2	4.0	1.2	4.5	155
LM3Z7V5T1G	0G	7.0	7.5	7.9	5	15	160	0.5	1	5.0	2.5	5.3	140
LM3Z8V2T1G	0H	7.7	8.2	8.7	5	15	160	0.5	0.7	5.0	3.2	6.2	135
LM3Z9V1T1G	0K	8.5	9.1	9.6	5	15	160	0.5	0.2	7.0	3.8	7.0	130
LM3Z10VT1G	0L	9.4	10	10.6	5	20	160	0.5	0.1	8.0	4.5	8.0	130
LM3Z11VT1G	0M	10.4	11	11.6	5	20	160	0.5	0.1	8.0	5.4	9.0	130
LM3Z12VT1G	0N	11.4	12	12.7	5	25	80	0.5	0.1	8.0	6.0	10	130
LM3Z13VT1G	0P	12.4	13.25	14.1	5	30	80	0.5	0.1	8.0	7.0	11	120
LM3Z15VT1G	0T	14.3	15	15.8	5	30	400	0.5	0.05	10.5	9.2	13	110
LM3Z16VT1G	0U	15.3	16.2	17.1	5	40	400	0.5	0.05	11.2	10.4	14	105
LM3Z18VT1G	0W	16.8	18	19.1	5	45	400	0.5	0.05	12.6	12.4	16	100
LM3Z20VT1G	0Z	18.8	20	21.2	5	55	500	0.5	0.05	14.0	14.4	18	85
LM3Z22VT1G	10	20.8	22	23.3	5	55	500	0.5	0.05	15.4	16.4	20	85
LM3Z24VT1G	11	22.8	24.2	25.6	5	70	120	0.5	0.05	16.8	18.4	22	80
LM3Z27VT1G	12	25.1	27	28.9	2	80	300	0.5	0.05	18.9	21.4	25.3	70
LM3Z30VT1G	14	28	30	32	2	80	300	0.5	0.05	21.0	24.4	29.4	70
LM3Z33VT1G	18	31	33	35	2	80	300	0.5	0.05	23.2	27.4	33.4	70
LM3Z36VT1G	19	34	36	38	2	90	500	0.5	0.05	25.2	30.4	37.4	70
LM3Z39VT1G	20	37	39	41	2	130	500	0.5	0.05	27.3	33.4	41.2	45
LM3Z43VT1G	21	40	43	46	2	150	500	0.5	0.05	30.1	37.6	46.6	40
LM3Z47VT1G	1A	44	47	50	2	170	500	0.5	0.05	32.9	42.0	51.8	40
LM3Z51VT1G	1C	48	51	54	2	180	500	0.5	0.05	35.7	46.6	57.2	40
LM3Z56VT1G	1D	52	56	60	2	200	500	0.5	0.05	39.2	52.2	63.8	40
LM3Z62VT1G	1E	58	62	66	2	215	500	0.5	0.05	43.4	58.8	71.6	35
LM3Z68VT1G	1F	64	68	72	2	240	500	0.5	0.05	47.6	65.6	79.8	35
LM3Z75VT1G	1G	70	75	79	2	255	500	0.5	0.05	52.5	73.4	88.6	35

2. Zener voltage is measured with a pulse test current  $I_Z$  at an ambient temperature of  $25^\circ\text{C}$ .

## Typical Characteristics

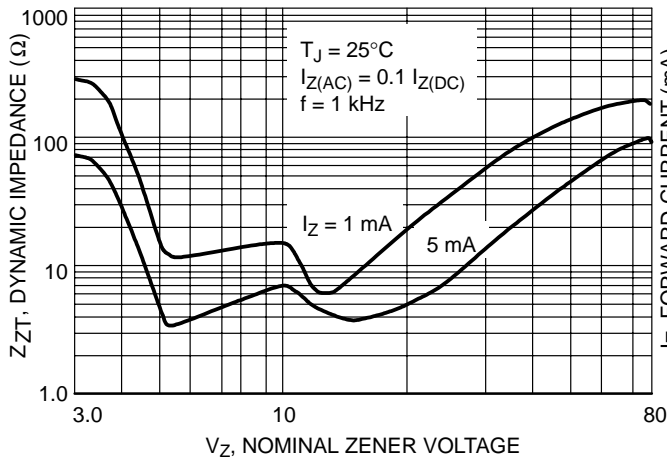

**Figure 1. Effect of Zener Voltage on Zener Impedance**

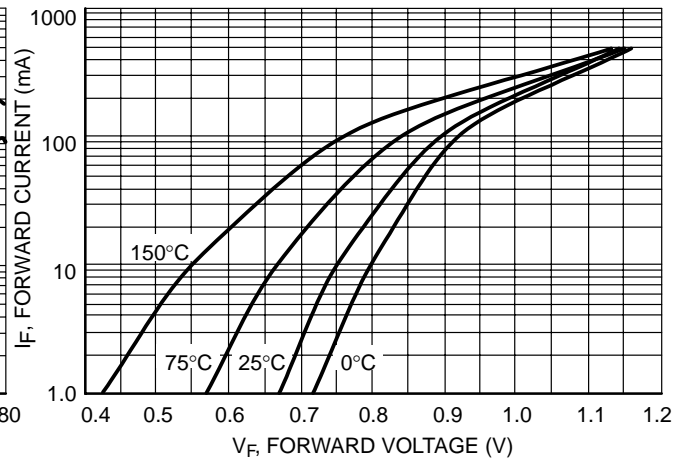

**Figure 2. Typical Forward Voltage**

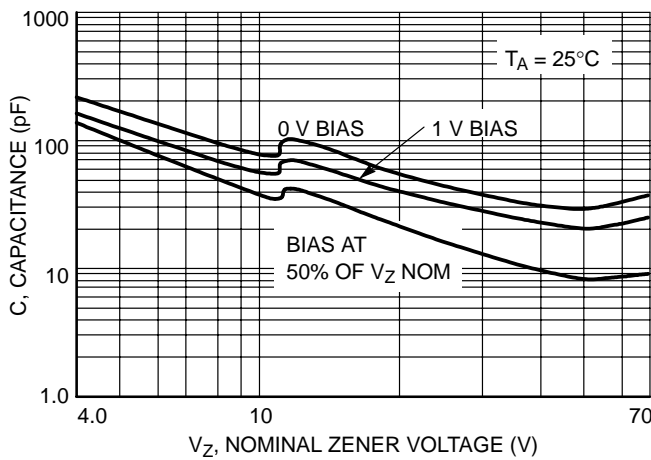

**Figure 3. Typical Capacitance**

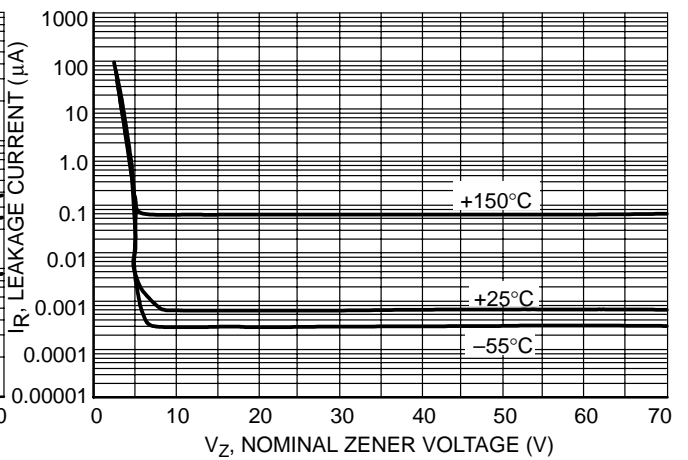

**Figure 4. Typical Leakage Current**

## Typical Characteristics

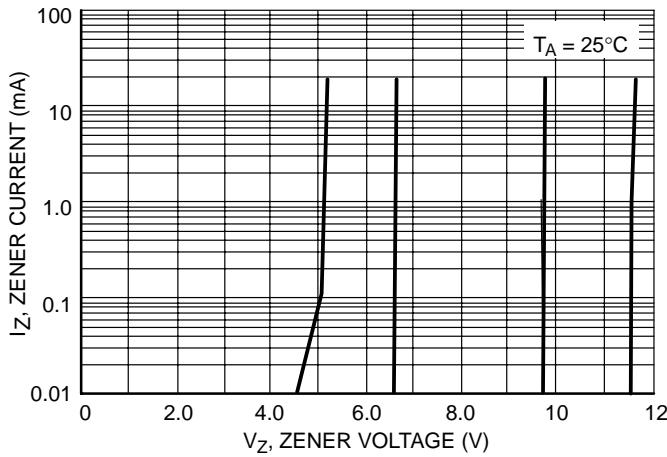

Figure 5. Zener Voltage versus Zener Current  
( $V_Z$  Up to 12 V)

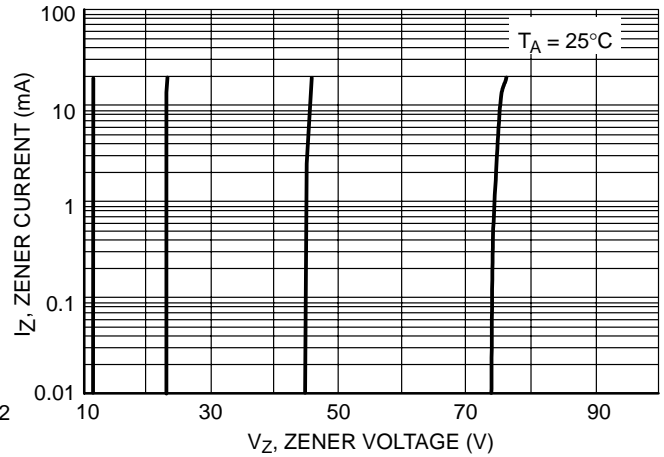

Figure 6. Zener Voltage versus Zener Current  
(12 V to 75 V)

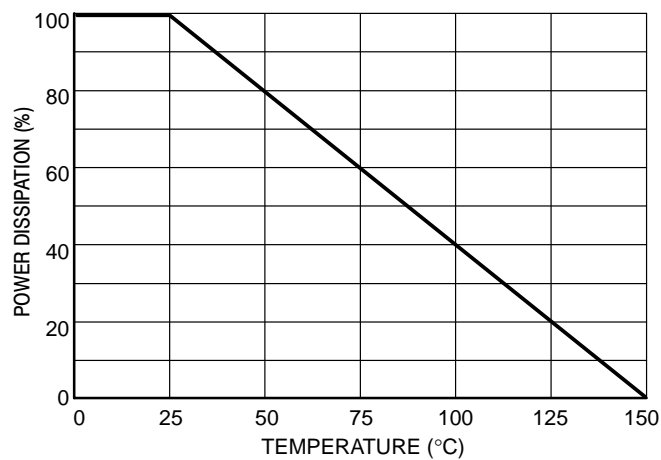
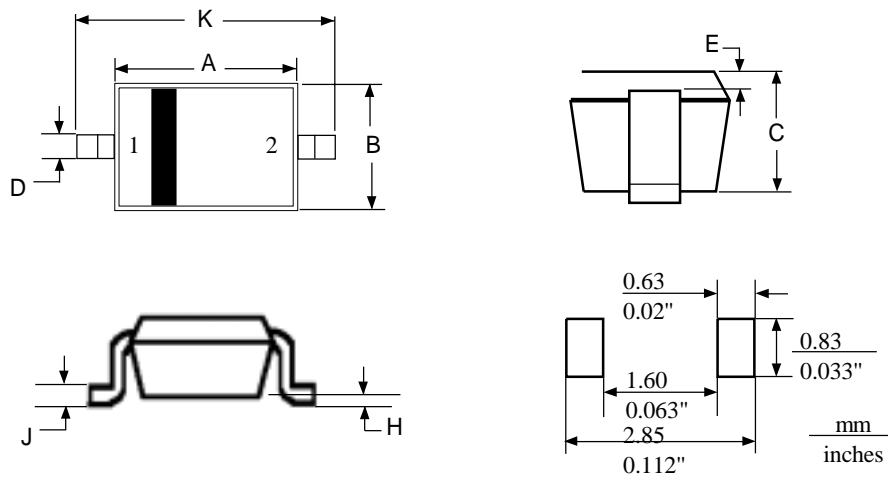

Figure 7. Steady State Power Derating

## PACKAGE DIMENSIONS SOD-323



- NOTES:
1. CONTROLLING DIMENSION: MILLIMETERS
  2. LEAD THICKNESS SPECIFIED PER L/F DRAWING WITH SOLDER PLATING.

DIN	MILLIMETERS		INCHES	
	MIN	MAX	MIN	MAX
A	1.60	1.80	0.063	0.071
B	1.15	1.35	0.045	0.053
C	0.80	1.00	0.031	0.039
D	0.25	0.40	0.010	0.016
E	0.15 REF		0.006 REF	
H	0.00	0.10	0.0000	0.004
J	0.089	0.177	0.0035	0.0070
K	2.30	2.70	0.091	0.106

STYLE 1:  
PIN 1: CATHODE  
2: ANODE

Shanghai Leiditech Electronic Co.,Ltd  
Email: sale1@leiditech.com  
Tel : +86- 021 50828806  
Fax : +86- 021 50477059