



Spec. No.	PS-ND-0712
Rev.	A

PRODUCT SPECIFICATION

Model No : CSS-2310S/CSS-2311S

Descriptions:

- 2.3 Inch Single Digit Alphanumeric Display
- Emitting Color: Super-Bright Red



CUSTOMER APPROVED	APPROVED BY	CHECKED BY	PREPARED BY
SIGNATURES			

CHINA SEMICONDUCTOR CORPORATION

Address:2FL. NO.909,Chung-Cheng Road,
Chung-Ho City Taipei Hsien,Taiwan.

Tel:886-2-2223-9696
Fax:886-2-2223-9377

OPTO PLUS TECHNOLOGIES CO.,LTD

Address:696 Shun jiang Rd.,Ji Shan St.Shaoxing,
ZheJiang,China

Tel:86-0575-8623888
Fax:86-0575-8623112



Spec. No.	PS-ND-0712
Rev.	A

Model No : CSS-2310S/2311S

Features -

1. 2.24 inch (56.8 mm) digit height.
2. Case mold type.
3. RoHs compliant.
4. Low power consumption.
5. Easy mounting on P.C. board or socket.

Device Selection Guide -

Part No.	Chip		Description
	Material	Emitted Color	
CSS-2310S	AlGaAs	Super-Bright Red	Common Anode
CSS-2311S			Common Cathode

Package Dimensions -

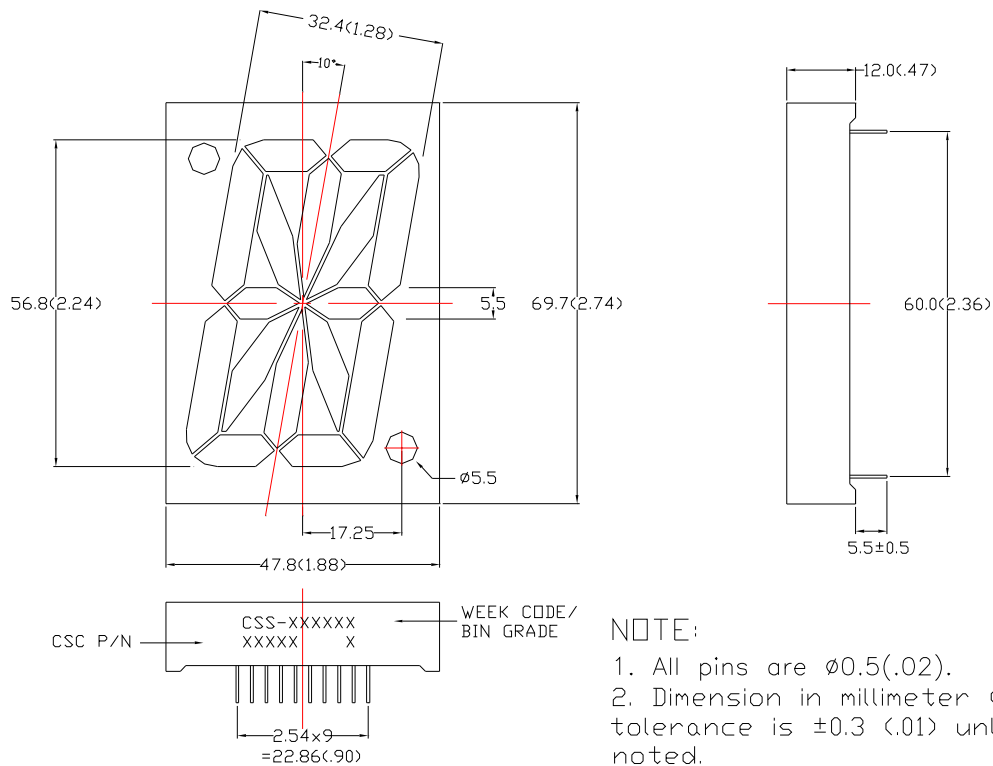

NOTE:

1. All pins are $\phi 0.5$ (.02).
2. Dimension in millimeter (inch), and tolerance is ± 0.3 (.01) unless otherwise noted.



Model No : CSS-2310S/2311S

Internal Circuit Diagrams -

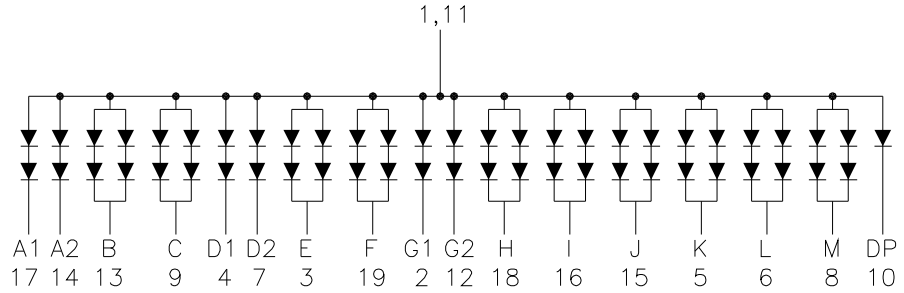
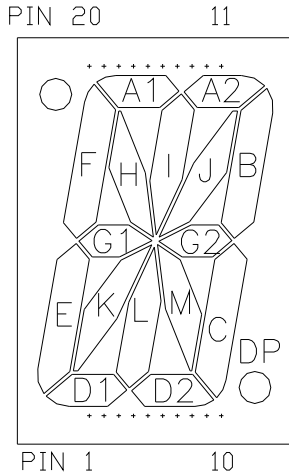

NO. 20 No Connection.
CSS-2310 Common Anode.
(CSS-2311 is Common Cathode.)

Absolute Maximum Rating -

(Ta=25°C)

Parameter	Symbol	Rating	Unit
Power Dissipation Per Dice	Pd	75	mW
Continuous Forward Current Per Dice	IAF	30	mA
Peak Current Per Dice (Duty Cycle 1/10, 1kHz)	IPF	125	mA
Derating Linear From 25°C Per Dice	-	0.42	mA/°C
Reverse Voltage Per Dice	VR	5	V
Operating Temperature	Topr	-25 ~ +85	°C
Storage Temperature	Tstg	-25 ~ +85	°C
Solder temperature 1/16 inch below seating plane for 3 seconds at 260°C			



Model No : CSS-2310S/2311S

■ Electro-optical Characteristics -

(Ta=25°C)

Parameter	Symbol	Min.	Typ.	Max.	Unit	Condition
Forward Voltage Per Segment (DP)	V _F	-	3.6(1.8)	5.0(2.5)	V	I _F =20mA
Luminous Intensity Per Segment	I _v	-	16	-	mcd	I _F =10mA
Peak Emission Wavelength	λ _p	-	660	-	nm	I _F =20mA
Spectrum Radiation Bandwidth	Δλ	-	20	-	nm	I _F =20mA
Reverse Current	I _R	-	-	100	μA	V _R =10V
Luminous Intensity Matching Ratio	I _V -m	-	-	2 : 1	-	I _F =20mA



Spec. No.	PS-ND-0712
Rev.	A

Model No : CSS-2310S/2311S

Typical Electrical / Optical Characteristics Curves -

(Ta = 25°C Unless Otherwise Noted)

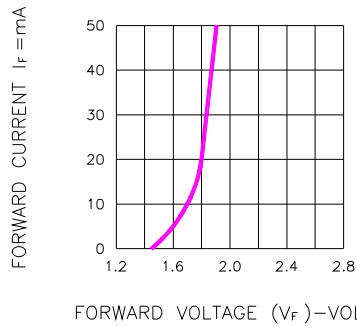

Fig.1 FORWARD CURRENT VS. FORWARD VOLTAGE

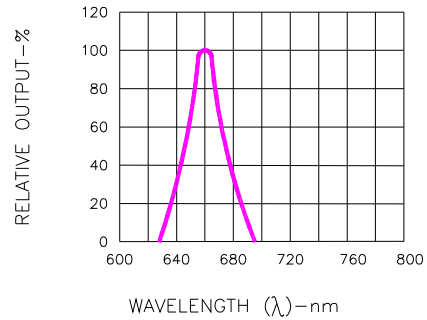

Fig.2 SPECTRAL RESPONSE

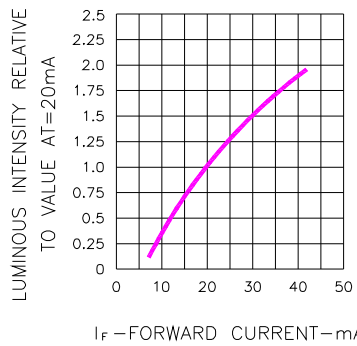

Fig.3 RELATIVE LUMINOUS INTENSITY VS. FORWARD CURRENT

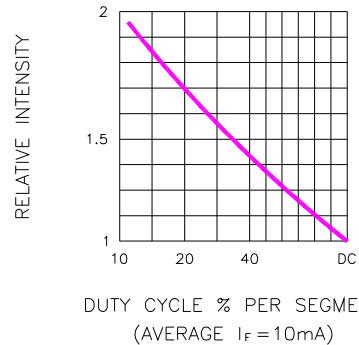

Fig.5 LUMINOUS INTENSITY VS. DUTY CYCLE

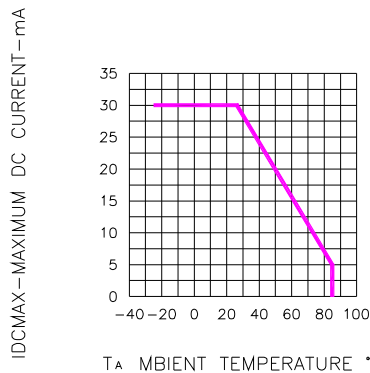

Fig.4 MAXIMUM ALLOWABLE DC CURRENT PER SEGMENT VS. A FUNCTION OF AMBIENT TEMPERATURE

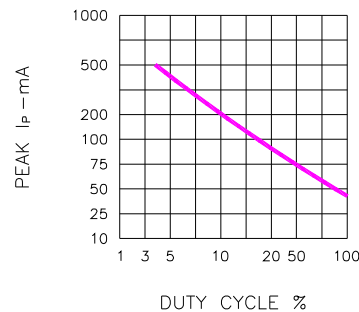

Fig.6 MAX PEAK CURRENT VS. DUTY CYCLE % (REFRESH RATE f=1 KHz)



Spec. No.	PS-ND-0712
Rev.	A

Model No : CSS-2310S/2311S

■ Package Dimensions

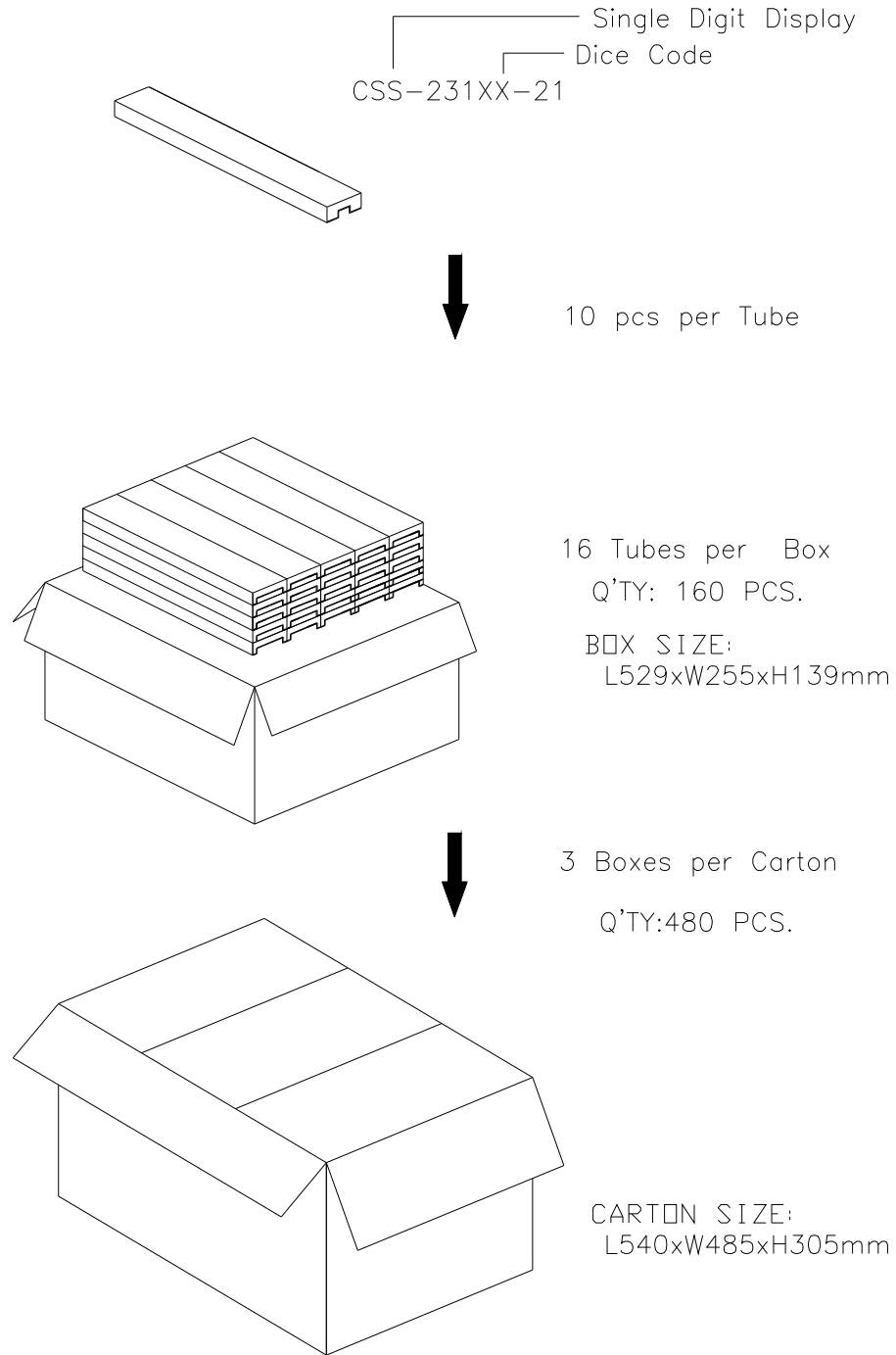

Note: The specifications may be changed without prior notice. Please contact us for the latest specifications.