



# Photocoupler

## Product Data Sheet

### LTV-100X-G series datasheet

Spec No.: DS70-2013-0012

Effective Date: 11/03/2016

Revision: G

**LITE-ON DCC**

**RELEASE**

BNS-OD-FC001/A4

## Photocoupler LTV-10XX-G series

### 1. DESCRIPTION

#### 1.1 Features

- Current transfer ratio ( CTR : MIN. 50% at  $I_F = 5\text{mA}$ ,  $V_{CE} = 5\text{V}$ ,  $T_a = 25^\circ\text{C}$  )
- High input-output isolation voltage (  $V_{iso} = 5,000\text{Vrms}$  )
- High collector-emitter voltage (  $V_{CEO} = 70\text{V}$  )
- Temperature range  $-55^\circ\text{C}$  to  $110^\circ\text{C}$
- Creepage distance > 8mm
- Employs double transfer mold technology
- Long Mini-flat package : 2.3mm profile : LTV-10XX series
- Halogen Free
- 8P-Free
- Safety approval
  - UL 1577
  - Cul CA5A
  - VDE DIN EN60747-5-5 (VDE 0884-5)
  - CQC GB4943.1-2011/ GB8898-2011 (meet Altitude up to 5000m)
  - Nordic Safety ( FIMKO/NEMKO/SEMKO/DEMKO)
- RoHS Compliance
  - All materials be used in device are followed EU RoHS directive (No.2002/95/EC).

#### 1.2 Applications

- Hybrid substrates that require high density mounting.
- Programmable controllers

## Photocoupler LTV-10XX-G series

### 2. PACKAGE DIMENSIONS

#### 2.1 LTV-10XX-G series

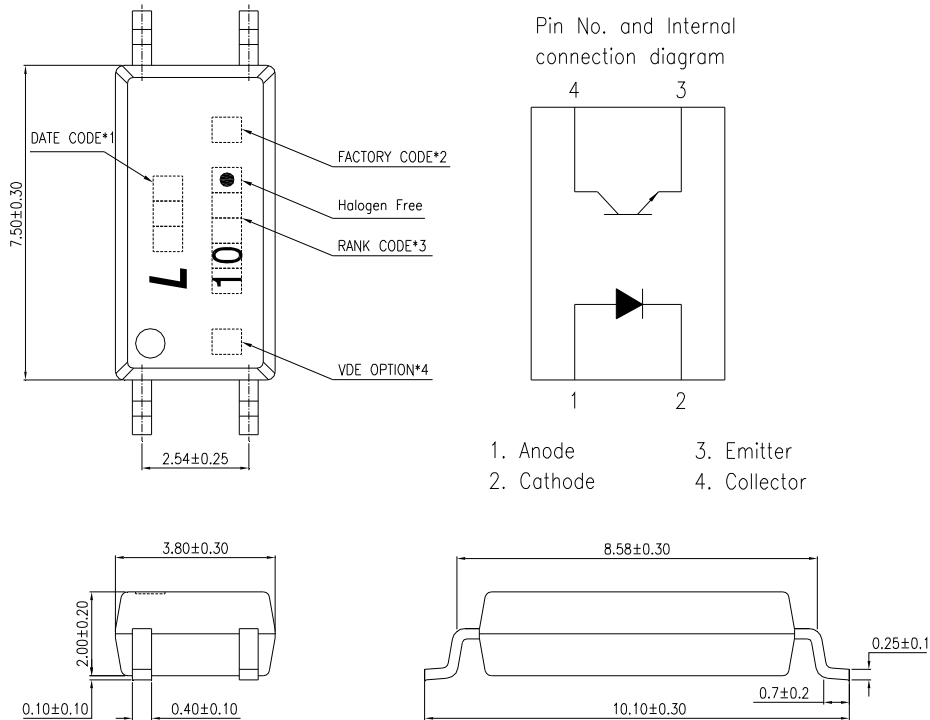

#### Notes :

1. 1-digit year code, Example : 2010 = A  
2-digit work week ranging from '01' to '53'
2. Factory identification mark shall be marked. (W : China-CZ, X: China -TJ)
3. CTR rank.
4. "4" or "V" for VDE option.

\*All dimensions in millimeters.

## Photocoupler LTV-10XX-G series

### 3. TAPING DIMENSIONS

#### 3.1 LTV-10XX-TP

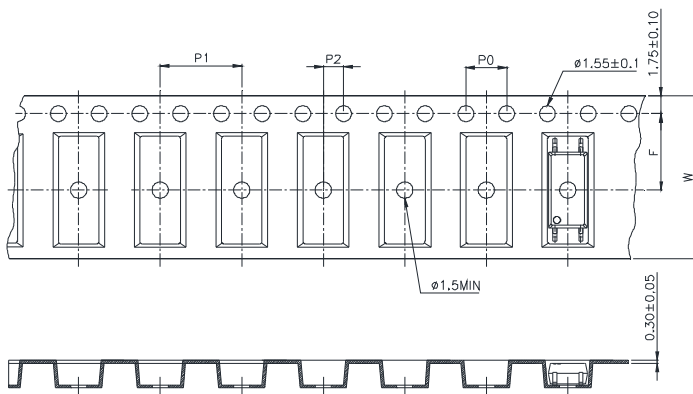

#### 3.2 LTV-10XX-TP1

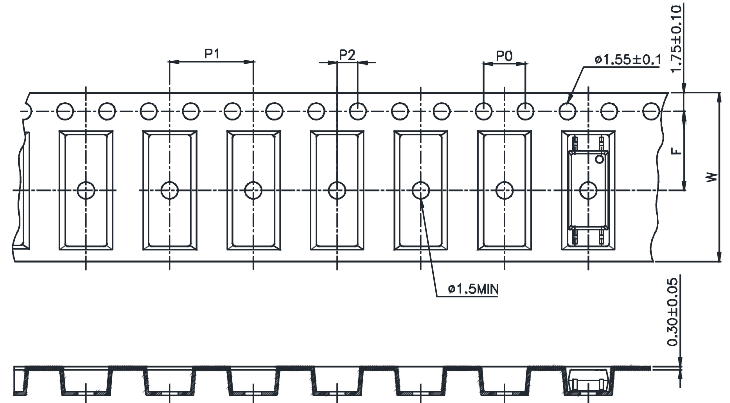

Description	Symbol	Dimension in mm (inch)
Tape wide	W	16±0.3 (.63)
Pitch of sprocket holes	P <sub>0</sub>	4±0.1 (.15)
Distance of compartment	F	7.5±0.1 (.295)
	P <sub>2</sub>	2±0.1 (.079)
Distance of compartment to compartment	P <sub>1</sub>	8±0.1 (.315)

#### 3.3 Quantities Per Reel

Package Type	LTV-10XX series
Quantities (pcs)	3000

## Photocoupler LTV-10XX-G series

### 4. RATING AND CHARACTERISTICS

#### 4.1 Absolute Maximum Ratings at Ta=25°C

	Parameter	Symbol	Rating	Unit
Input	Forward Current	$I_F$	60	mA
	Reverse Voltage	$V_R$	6	V
	Power Dissipation	$P$	100	mW
	Junction Temperature	$T_J$	125	°C
	Thermal Resistance Junction to Ambient	$R_{thJ-A}$	250	°C/W
	Thermal Resistance Junction to Case	$R_{thJ-C}$	180	°C/W
Output	Collector - Emitter Voltage	$V_{CEO}$	70	V
	Emitter - Collector Voltage	$V_{ECO}$	7	V
	Collector Current	$I_C$	50	mA
	Collector Power Dissipation	$P_C$	150	mW
	Junction Temperature	$T_J$	125	°C
	Total Power Dissipation	$P_{tot}$	250	mW
1.	Isolation Voltage	$V_{iso}$	5000	$V_{rms}$
	Operating Temperature	$T_{opr}$	-55 ~ +110	°C
	Storage Temperature	$T_{stg}$	-55 ~ +150	°C
2.	Soldering Temperature	$T_{sol}$	260	°C

1. AC For 1 Minute, R.H. = 40 ~ 60%

Isolation voltage shall be measured using the following method.

- (1) Short between anode and cathode on the primary side and between collector and emitter on the secondary side.
- (2) The isolation voltage tester with zero-cross circuit shall be used.
- (3) The waveform of applied voltage shall be a sine wave.

2. For 10 Seconds

## Photocoupler LTV-10XX-G series

### 4.2 ELECTRICAL OPTICAL CHARACTERISTICS at Ta=25°C

Parameter		Symbol	Min.	Typ.	Max.	Unit	Test Condition
Input	Forward Voltage	$V_F$	—	1.25	1.6	V	$I_F=50\text{mA}$
	Reverse Current	$I_R$	—	—	10	$\mu\text{A}$	$V_R=4\text{V}$
	Terminal Capacitance	$C_t$	—	50	—	pF	$V=0, f=1\text{MHz}$
Output	Collector Dark Current	$I_{CEO}$	—	10	100	nA	$V_{CE}=20\text{V}, I_F=0$
	Collector- Emitter Breakdown Voltage	$BV_{CEO}$	70	—	—	V	$I_C=1\text{mA}, I_F=0$
	Emitter-Collector Breakdown Voltage	$BV_{ECO}$	7	—	—	V	$I_E=100\mu\text{A}, I_F=0$
TRANSFER CHARACTERISTICS	Collector Current	$I_C$	2.5	—	30	mA	$I_F=5\text{mA}$
	1. Current Transfer Ratio	CTR	50	—	600	%	$V_{CE}=5\text{V}$
	Collector-Emitter Saturation Voltage	$V_{CE(sat)}$	—	—	0.3	V	$I_F=10\text{mA}$ $I_C=1\text{mA}$
	Isolation Resistance	$R_{iso}$	$10^{12}$	—	—	$\Omega$	DC500V, 40 ~ 60% R.H.
	Floating Capacitance	$C_f$	—	0.3	—	pF	$V=0, f=1\text{MHz}$
	Response Time (Rise)	$t_r$	—	3	18	$\mu\text{s}$	$V_{CC}=5\text{V},$ $I_C=2\text{mA}$
	Response Time (Fall)	$t_f$	—	4.7	18	$\mu\text{s}$	$R_L=100\Omega,$

$$1. \text{ CTR} = \frac{I_C}{I_F} \times 100\%$$

**Photocoupler  
LTV-10XX-G series**

**5. RANK TABLE OF CURRENT TRANSFER RATIO CTR**

CTR Rank	Min.	Typ.	Max.	Unit	Condition
LTV-1000	50	—	600	%	$I_F=5mA, V_{CE}=5V, T_a=25^{\circ}C$
LTV-1001	100	—	160		
LTV-1004	100	—	200		
LTV-1005	50	—	150		
LTV-1006	100	—	300		
LTV-1007	80	—	160		
LTV-1008	130	—	260		
LTV-1009	200	—	400		
LTV-1010	150	—	300		
LTV-1019	250	—	500		
LTV-1020	300	—	450		
LTV-1002	22	—	—	%	$I_F=1mA, V_{CE}=5V, T_a=25^{\circ}C$
LTV-1003	34	—	—		
LTV-1014	56	—	—		
LTV-1015	63	—	125		
LTV-1018	100	—	200	%	$I_F=10mA, V_{CE}=5V, T_a=25^{\circ}C$
LTV-1002	63	—	125		
LTV-1003	100	—	200		
LTV-1014	160	—	320		

# Photocoupler LTV-10XX-G series

## 6. CHARACTERISTICS CURVES (TYPICAL PERFORMANCE)

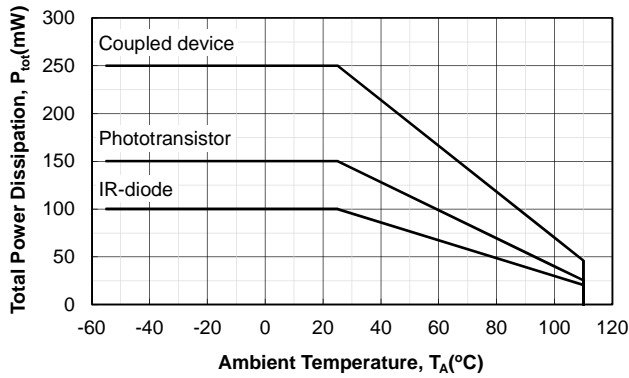

Figure 1.  $P_{tot}$  vs.  $T_A$

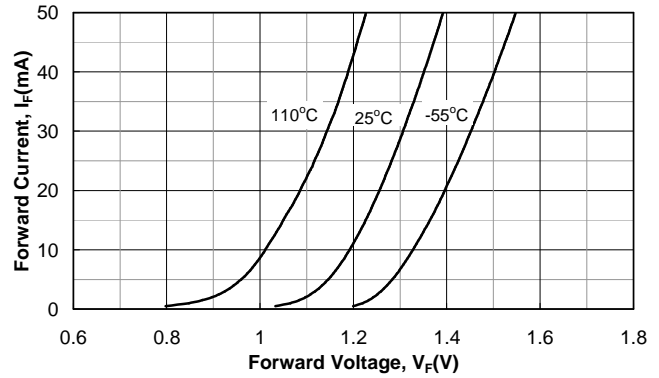

Figure 4.  $I_F$  vs.  $V_F$

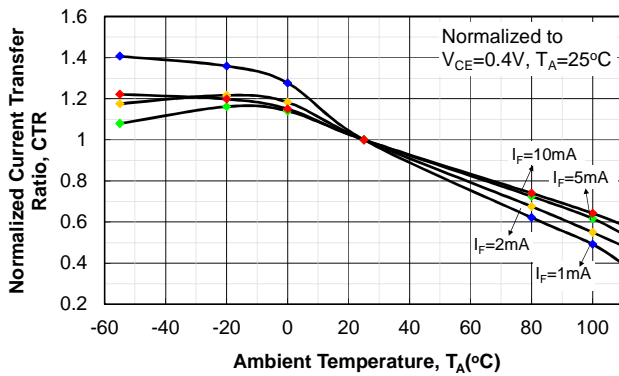

Figure 2. Saturated Normalized CTR vs.  $T_A$

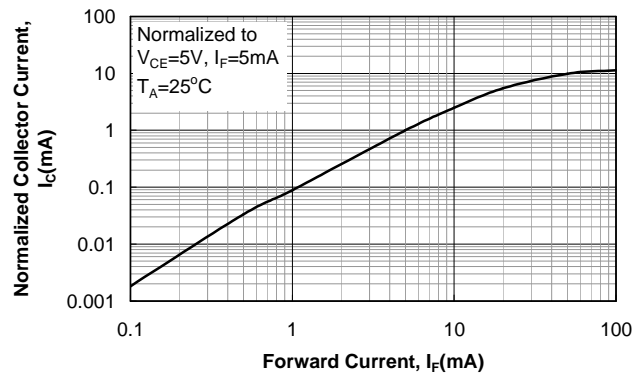

Figure 5. Normalized  $I_C$  vs.  $I_F$

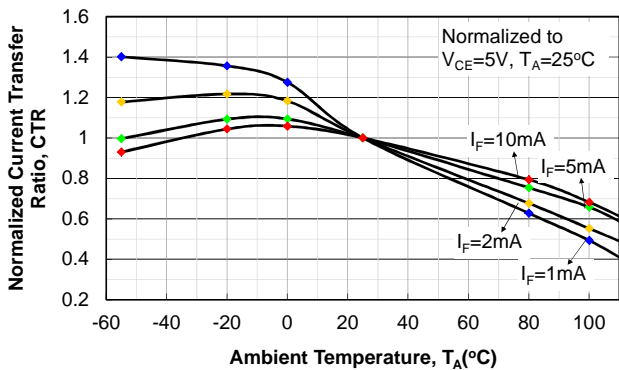

Figure 3. Non-saturated Normalized CTR vs.  $T_A$

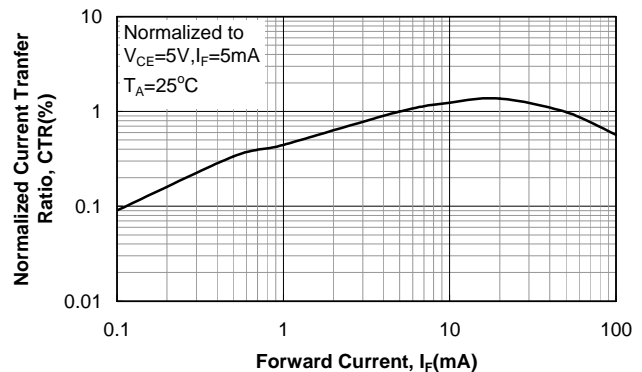

Figure 6. Normalized CTR vs.  $I_F$



## Photocoupler LTV-10XX-G series

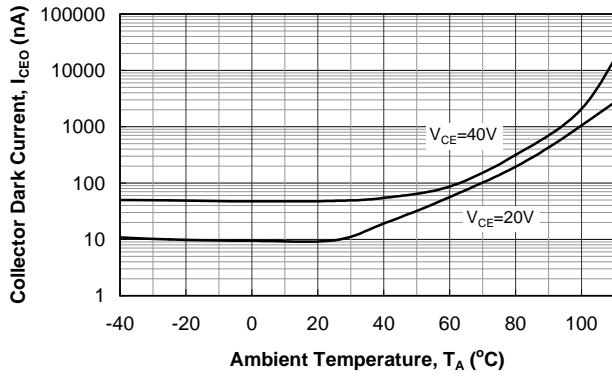

Figure 7.  $I_{CEO}$  vs.  $T_A$

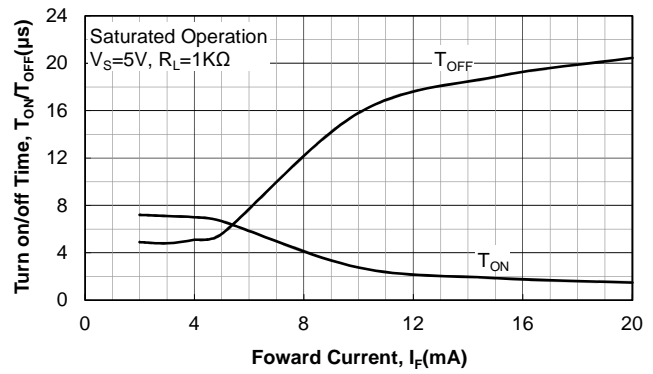

Figure 10.  $T_{ON} / T_{OFF}$  vs.  $I_F$

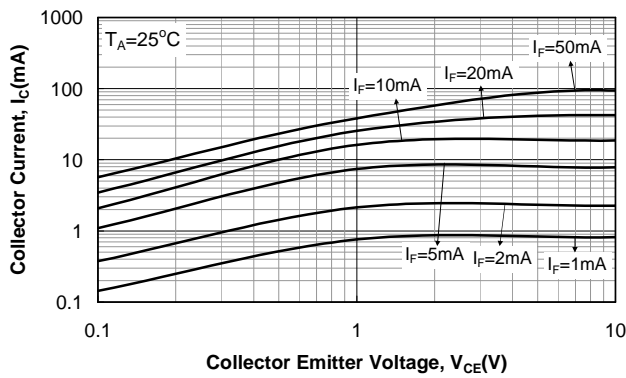

Figure 8.  $I_C$  vs.  $V_{CE}$

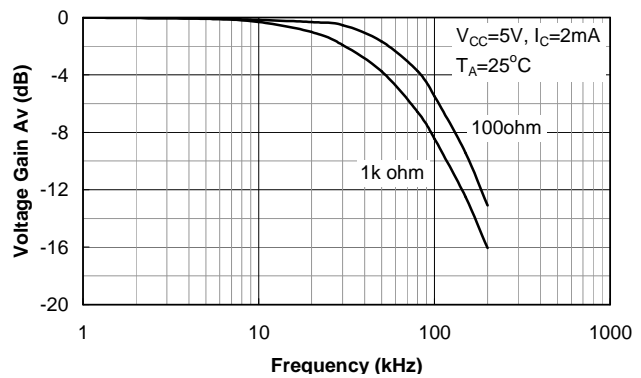

Figure 11. Frequency Response

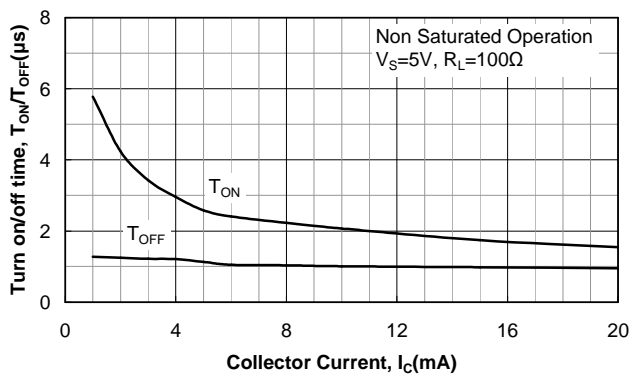

Figure 9.  $T_{ON} / T_{OFF}$  vs.  $I_C$

# Photocoupler LTV-10XX-G series

## 7. TEMPERATURE PROFILE OF SOLDERING

### 7.1 IR Reflow soldering (JEDEC-STD-020C compliant)

One time soldering reflow is recommended within the condition of temperature and time profile shown below. Do not solder more than three times.

Profile item	Conditions
Preheat	
- Temperature Min ( $T_{Smin}$ )	150°C
- Temperature Max ( $T_{Smax}$ )	200°C
- Time (min to max) (ts)	90±30 sec
Soldering zone	
- Temperature ( $T_L$ )	217°C
- Time ( $t_L$ )	60 sec
Peak Temperature ( $T_P$ )	260°C
Ramp-up rate	3°C / sec max.
Ramp-down rate	3~6°C / sec

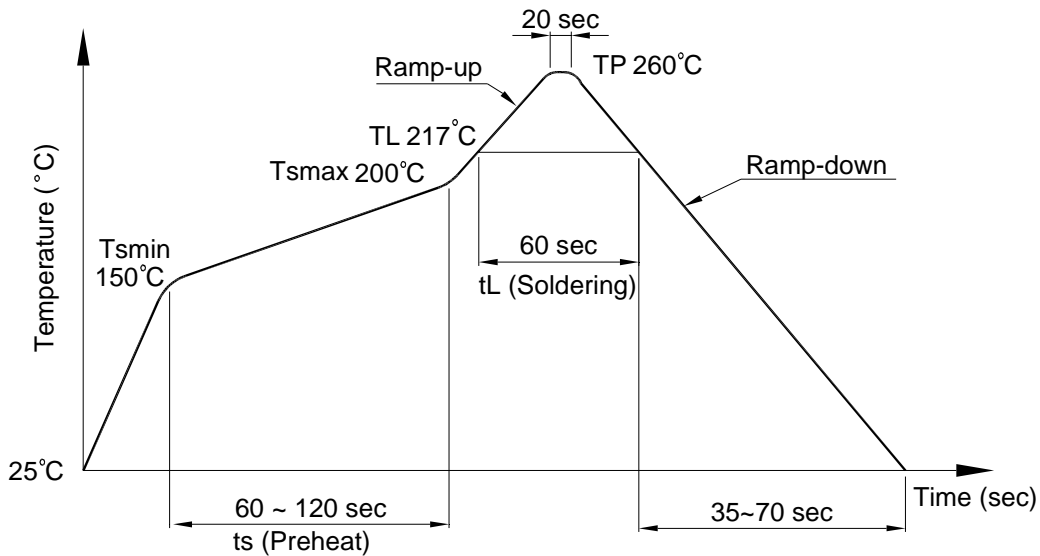

**Photocoupler  
LTV-10XX-G series**

**7.2 Wave soldering (JEDEC22A111 compliant)**

One time soldering is recommended within the condition of temperature.

Temperature:  $260+0/-5^{\circ}\text{C}$

Time: 10 sec.

Preheat temperature: 25 to  $140^{\circ}\text{C}$

Preheat time: 30 to 80 sec.

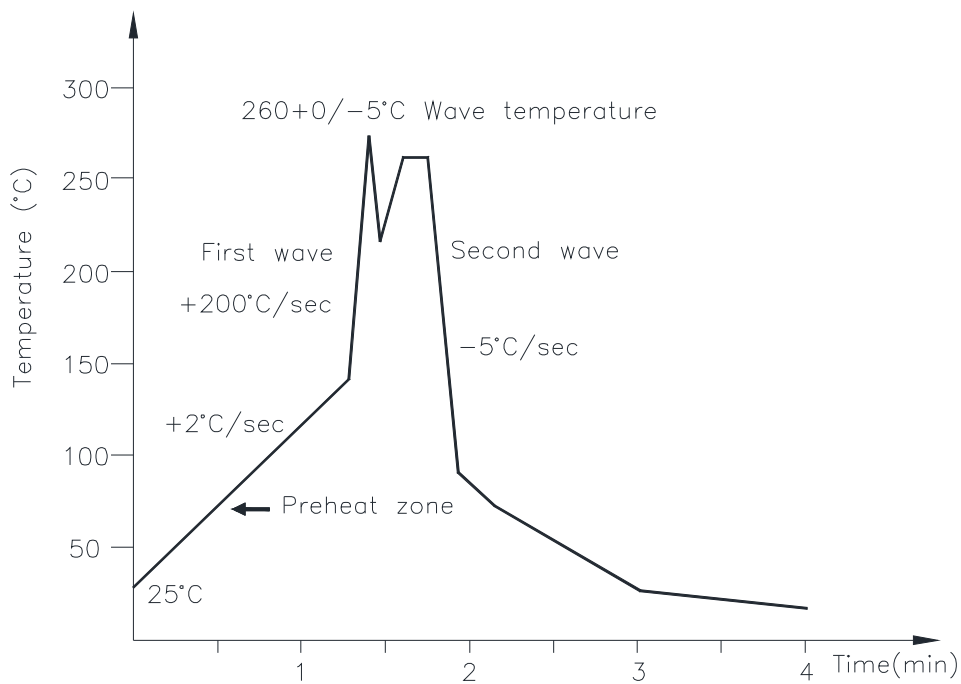

**7.3 Hand soldering by soldering iron**

Allow single lead soldering in every single process. One time soldering is recommended.

Temperature:  $380+0/-5^{\circ}\text{C}$

Time: 3 sec max.

Photocoupler  
LTV-10XX-G series

8. RRECOMMENDED FOOT PRINT PATTERNS (MOUNT PAD)

Unit: mm

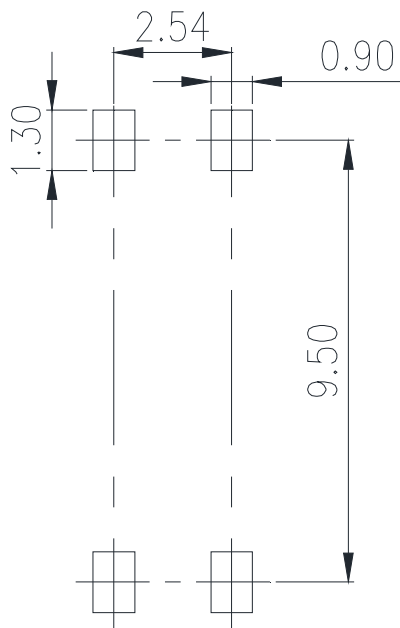

**Photocoupler  
LTV-10XX-G series**

**9. NAMING RULE**

**LTV-10XX-(2)-G**

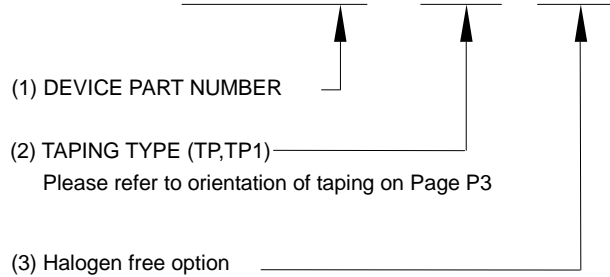

Example : LTV-1008-TP-G

**LTV 10XX (2) -V-G**

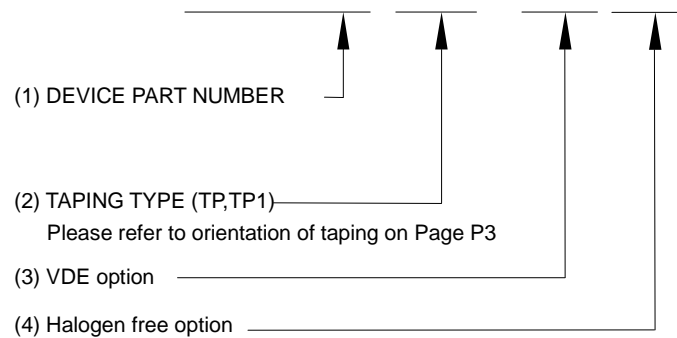

Example : LTV1008TP-V-G

**10. NOTES**

- LiteOn is continually improving the quality, reliability, function or design and LiteOn reserves the right to make changes without further notices.
- The products shown in this publication are designed for the general use in electronic applications such as office automation equipment, communications devices, audio/visual equipment, electrical application and instrumentation.
- For equipment/devices where high reliability or safety is required, such as space applications, nuclear power control equipment, medical equipment, etc, please contact our sales representatives.
- When requiring a device for any "specific" application, please contact our sales in advice.
- If there are any questions about the contents of this publication, please contact us at your convenience.
- The contents described herein are subject to change without prior notice.
- Immerge unit's body in solder paste is not recommended.