

## TV06B5V0-G Thru. TV06B441-G

**Working Peak Reverse voltage: 5.0 ~ 440Volts**  
**Power Dissipation: 600 Watts**  
**RoHS Device**

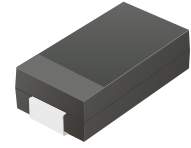

### Features

- Ideally for surface mount applications.
- Easy pick and place.
- Plastic package has Underwriters Lab. flammability classification 94V-0.
- Typical IR less than 1 $\mu$ A above 10V.
- Fast response time: typically less than 1nS for uni-direction, less than 5nS for bi-directional, form 0V to BV min.

### Mechanical Data

- Case: JEDEC DO-214AA molded plastic.
- Terminals: solderable per MIL-STD-750, method 2026
- Polarity: Cathode band denoted.
- Weight: 0.093 gram approx.

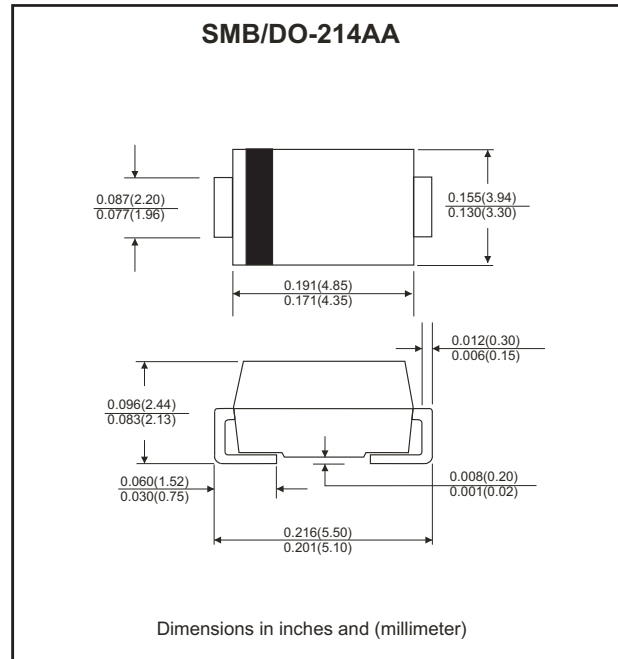

### Maximum Ratings and Electrical Characteristics

Rating at 25 °C ambient temperature unless otherwise specified.  
 Single phase, half wave, 60Hz, resistive or inductive load.  
 For capacitive load, derate current by 20%.

Characteristics	Symbol	Value	Units
Peak power dissipation on 10/1000 $\mu$ S waveform (Note 1, Fig.1)	P <sub>PPM</sub>	600	W
Peak pulse current on 10/1000 $\mu$ S waveform (Note 1, Fig.3)	I <sub>PPM</sub>	See Next Table	A
Steady state power dissipation at T <sub>L</sub> =75 °C (Note 2)	P <sub>M(AV)</sub>	5.0	W
Peak forward surge current, 8.3mS single half sine-wave superimposed on rated load, uni-directional only (Note 3)	I <sub>FSM</sub>	100	A
Maximum instantaneous forward voltage at 35.0A for uni-directional only (Note 3, 4)	V <sub>F</sub>	3.5/5.0	V
Maximum operation junction temperature	T <sub>J</sub>	150	°C
Storage temperature range	T <sub>STG</sub>	-55 to +150	°C

Note:

1. Non-repetitive current pulse, per Fig. 5 and derated above TA=25 °C per Fig.1
2. Measured on 8.3 mS single half sine-wave or equivalent square wave, duty cycle=4 pulse per minute maximum.
3. V<sub>F</sub><3.5V for devices of V<sub>BR</sub> <200V and V<sub>F</sub> <5.0V for devices of V<sub>BR</sub> >201V

# SMD Transient Voltage Suppressor



## Electrical Characteristics (TV06B5V0-G Thru. TV06B441-G)

Part No.	Absolute Maximum Rating (T <sub>A</sub> =25°C)					Electrical Characteristic (T <sub>A</sub> =25°C)				
	V <sub>RWM</sub>	V <sub>BR</sub> Min.	V <sub>BR</sub> Max.	I <sub>T</sub>	I <sub>FSM</sub>	Max V <sub>C</sub>		I <sub>R</sub> @V <sub>RWM</sub>	Marking Code	
	(V)	(V)	(V)	(mA)	(A)@8.3mS	(V)	I <sub>PP</sub> (A)	(uA)	UNI	BI
TV06B5V0K(B)-G	5.00	6.40	7.30	10	100	9.6	62.50	800	KD	AD
TV06B5V0J(B)-G	5.00	6.40	7.00	10	100	9.2	65.22	800	KE	AE
TV06B6V0K(B)-G	6.00	6.67	8.15	10	100	11.4	52.63	800	KF	AF
TV06B6V0J(B)-G	6.00	6.67	7.37	10	100	10.3	58.25	800	KG	AG
TV06B6V5K(B)-G	6.50	7.22	8.82	10	100	12.3	48.78	500	KH	AH
TV06B6V5J(B)-G	6.50	7.22	7.98	10	100	11.2	53.57	500	KK	AK
TV06B7V0K(B)-G	7.00	7.78	9.51	1	100	13.3	45.11	200	KL	AL
TV06B7V0J(B)-G	7.00	7.78	8.60	1	100	12.0	50.00	200	KM	AM
TV06B7V5K(B)-G	7.50	8.33	10.20	1	100	14.3	41.96	100	KN	AN
TV06B7V5J(B)-G	7.50	8.33	9.21	1	100	12.9	46.51	100	KP	AP
TV06B8V0K(B)-G	8.00	8.89	10.90	1	100	15.0	40.00	50	KQ	AQ
TV06B8V0J(B)-G	8.00	8.89	9.83	1	100	13.6	44.12	50	KR	AR
TV06B8V5K(B)-G	8.55	9.44	11.50	1	100	15.9	37.74	10	KS	AS
TV06B8V5J(B)-G	8.55	9.44	10.40	1	100	14.4	41.67	10	KT	AT
TV06B9V0K(B)-G	9.00	10.00	12.20	1	100	16.9	35.50	5	KU	AU
TV06B9V0J(B)-G	9.00	10.00	11.10	1	100	15.4	38.96	5	KV	AV
TV06B100K(B)-G	10.0	11.10	13.60	1	100	18.8	31.90	5	KW	AW
TV06B100J(B)-G	10.0	11.10	12.30	1	100	17.0	35.29	5	KX	AX
TV06B110K(B)-G	11.0	12.20	14.90	1	100	20.1	29.85	5	KY	AY
TV06B110J(B)-G	11.0	12.20	13.50	1	100	18.2	32.97	5	KZ	AZ
TV06B120K(B)-G	12.0	13.30	16.30	1	100	22.0	27.27	5	LD	BD
TV06B120J(B)-G	12.0	13.30	14.70	1	100	19.9	30.15	5	LE	BE
TV06B130K(B)-G	13.0	14.40	17.60	1	100	23.8	25.21	5	LF	BF
TV06B130J(B)-G	13.0	14.40	15.90	1	100	21.5	27.91	5	LG	BG
TV06B140K(B)-G	14.0	15.60	19.10	1	100	25.8	23.26	5	LH	BH
TV06B140J(B)-G	14.0	15.60	17.20	1	100	23.2	25.86	5	LK	BK
TV06B150K(B)-G	15.0	16.70	20.40	1	100	26.9	22.30	5	LL	BL
TV06B150J(B)-G	15.0	16.70	18.50	1	100	24.4	24.59	5	LM	BM
TV06B160K(B)-G	16.0	17.80	21.80	1	100	28.8	20.83	5	LN	BN
TV06B160J(B)-G	16.0	17.80	19.70	1	100	26.0	19.67	5	LP	BP
TV06B170K(B)-G	17.0	18.90	23.10	1	100	30.5	21.74	5	LQ	BQ
TV06B170J(B)-G	17.0	18.90	20.90	1	100	27.6	18.63	5	LR	BR
TV06B180K(B)-G	18.0	20.00	24.40	1	100	32.2	20.55	5	LS	BS
TV06B180J(B)-G	18.0	20.00	22.10	1	100	29.2	17.64	5	LT	BT
TV06B200K(B)-G	20.0	22.20	27.10	1	100	35.8	19.76	5	LU	BU
TV06B200J(B)-G	20.0	22.20	24.50	1	100	32.4	18.52	5	LV	BV
TV06B220K(B)-G	22.0	24.40	29.80	1	100	39.4	15.23	5	LW	BW
TV06B220J(B)-G	22.0	24.40	26.90	1	100	35.5	16.90	5	LX	BX
TV06B240K(B)-G	24.0	26.70	32.60	1	100	43.0	13.95	5	LY	BY
TV06B240J(B)-G	24.0	26.70	29.50	1	100	38.9	15.42	5	LZ	BZ
TV06B260K(B)-G	26.0	28.90	35.30	1	100	46.6	12.88	5	MD	CD
TV06B260J(B)-G	26.0	28.90	31.90	1	100	42.1	14.25	5	ME	CE
TV06B280K(B)-G	28.0	31.10	38.00	1	100	50.0	12.00	5	MF	CF
TV06B280J(B)-G	28.0	31.10	34.40	1	100	45.4	13.22	5	MG	CG
TV06B300K(B)-G	30.0	33.30	40.70	1	100	53.5	11.21	5	MH	CH
TV06B300J(B)-G	30.0	33.30	36.80	1	100	48.4	12.40	5	MK	CK
TV06B330K(B)-G	33.0	36.70	44.90	1	100	59.0	10.17	5	ML	CL
TV06B330J(B)-G	33.0	36.70	40.60	1	100	53.3	11.26	5	MM	CM
TV06B360K(B)-G	36.0	40.00	48.90	1	100	64.3	9.33	5	MN	CN
TV06B360J(B)-G	36.0	40.00	44.20	1	100	58.1	10.33	5	MP	CP
TV06B400K(B)-G	40.0	44.40	54.30	1	100	71.4	8.40	5	MQ	CQ
TV06B400J(B)-G	40.0	44.40	49.10	1	100	64.5	9.30	5	MR	CR

# SMD Transient Voltage Suppressor



## Electrical Characteristics (TV06B5V0-G Thru. TV06B441-G)

Part No.	Absolute Maximum Rating ( $T_A = 25^\circ\text{C}$ )					Electrical Characteristic ( $T_A = 25^\circ\text{C}$ )				
	$V_{RWM}$	$V_{BR}$ Min.	$V_{BR}$ Max.	$I_T$	$I_{FSM}$	Max $V_C$		$I_R@V_{RWM}$	Marking Code	
	(V)	(V)	(V)	(mA)	(A)@8.3mS	(V)	$I_{PP}$ (A)	( $\mu\text{A}$ )	UNI	BI
TV06B430K(B)-G	43.0	47.80	58.40	1	100	76.7	7.82	5	MS	CS
TV06B430J(B)-G	43.0	47.80	52.80	1	100	69.4	8.65	5	MT	CT
TV06B450K(B)-G	45.0	50.00	61.10	1	100	80.3	7.47	5	MU	CU
TV06B450J(B)-G	45.0	50.00	55.30	1	100	72.7	8.25	5	MV	CV
TV06B480K(B)-G	48.0	53.30	65.10	1	100	85.5	7.02	5	MW	CW
TV06B480J(B)-G	48.0	53.30	58.90	1	100	77.4	7.75	5	MX	CX
TV06B510K(B)-G	51.0	56.70	69.30	1	100	91.1	6.59	5	MY	CY
TV06B510J(B)-G	51.0	56.70	62.70	1	100	82.4	7.28	5	MZ	CZ
TV06B540K(B)-G	54.0	60.00	73.30	1	100	96.3	6.23	5	ND	DD
TV06B540J(B)-G	54.0	60.00	66.30	1	100	87.1	6.89	5	NE	DE
TV06B580K(B)-G	58.0	64.40	78.70	1	100	103.0	5.83	5	NF	DF
TV06B580J(B)-G	58.0	64.40	71.20	1	100	93.6	6.41	5	NG	DG
TV06B600K(B)-G	60.0	66.70	81.50	1	100	107.0	5.61	5	NH	DH
TV06B600J(B)-G	60.0	66.70	73.70	1	100	96.8	6.20	5	NK	DK
TV06B640K(B)-G	64.0	71.10	86.90	1	100	114.0	5.26	5	NL	DL
TV06B640J(B)-G	64.0	71.10	78.60	1	100	103.0	5.83	5	NM	DM
TV06B700K(B)-G	70.0	77.80	95.10	1	100	125.0	4.80	5	NN	DN
TV06B700J(B)-G	70.0	77.80	86.00	1	100	113.0	5.31	5	NP	DP
TV06B750K(B)-G	75.0	83.30	102.00	1	100	134.0	4.48	5	NQ	DQ
TV06B750J(B)-G	75.0	83.30	92.10	1	100	121.0	4.96	5	NR	DR
TV06B780K(B)-G	78.0	86.70	106.00	1	100	139.0	4.32	5	NS	DS
TV06B780J(B)-G	78.0	86.70	95.80	1	100	126.0	4.76	5	NT	DT
TV06B800K(B)-G	80.0	88.96	108.80	1	100	143.2	4.19	5	NA	DA
TV06B800J(B)-G	80.0	98.80	97.60	1	100	129.6	4.63	5	NB	DB
TV06B850K(B)-G	85.0	94.40	115.00	1	100	151.0	3.97	5	NU	DU
TV06B850J(B)-G	85.0	94.40	104.00	1	100	137.0	4.38	5	NV	DV
TV06B900K(B)-G	90.0	100.00	122.00	1	100	160.0	3.75	5	NW	DW
TV06B900J(B)-G	90.0	100.00	111.00	1	100	146.0	4.11	5	NX	DX
TV06B101K(B)-G	100.0	111.00	136.00	1	100	179.0	3.35	5	NY	DY
TV06B101J(B)-G	100.0	111.00	123.00	1	100	162.0	3.70	5	NZ	DZ
TV06B111K(B)-G	110.0	122.00	149.00	1	100	196.0	3.06	5	PD	ED
TV06B111J(B)-G	110.0	122.00	135.00	1	100	177.0	3.39	5	PE	EE
TV06B121K(B)-G	120.0	133.00	163.00	1	100	214.0	2.8	5	PF	EF
TV06B121J(B)-G	120.0	133.00	147.00	1	100	193.0	3.1	5	PG	EG
TV06B131K(B)-G	130.0	144.00	176.00	1	100	231.0	2.6	5	PH	EH
TV06B131J(B)-G	130.0	144.00	159.00	1	100	209.0	2.9	5	PK	EK
TV06B141K(B)-G	140.0	155.68	190.40	1	100	250.6	2.6	5	PA	EA
TV06B141J(B)-G	140.0	155.00	171.00	1	100	226.8	2.9	5	PB	EB
TV06B151K(B)-G	150.0	167.00	204.00	1	100	268.0	2.2	5	PL	EL
TV06B151J(B)-G	150.0	167.00	185.00	1	100	243.0	2.5	5	PM	EM
TV06B161K(B)-G	160.0	178.00	218.00	1	100	287.0	2.09	5	PN	EN
TV06B161J(B)-G	160.0	178.00	197.00	1	100	259.0	2.32	5	PP	EP
TV06B171K(B)-G	170.0	189.00	231.00	1	100	304.0	1.97	5	PQ	EQ
TV06B171J(B)-G	170.0	189.00	209.00	1	100	275.0	2.18	5	PR	ER

# SMD Transient Voltage Suppressor



## Electrical Characteristics (TV06B5V0-G Thru. TV06B441-G)

Part No.	Absolute Maximum Rating (T <sub>A</sub> =25°C)					Electrical Characteristic (T <sub>A</sub> =25°C)				
	V <sub>RWM</sub>	V <sub>BR</sub> Min.	V <sub>BR</sub> Max.	I <sub>T</sub>	I <sub>FSM</sub>	Max V <sub>C</sub>		I <sub>R</sub> @V <sub>RWM</sub>	Marking Code	
	(V)	(V)	(V)	(mA)	(A)@8.3mS	(V)	I <sub>PP</sub> (A)	(uA)	UNI	BI
TV06B181K(B)-G	180.0	200.16	244.80	1	100	322.2	1.86	5	PS	ES
TV06B181J(B)-G	180.0	200.00	220.00	1	100	291.0	2.06	5	PT	ET
TV06B191K(B)-G	190.0	211.28	258.00	1	100	340.1	1.76	5	PU	EU
TV06B191J(B)-G	190.0	211.00	232.00	1	100	307.0	1.95	5	PV	EV
TV06B201J(B)-G	200.0	224.00	247.00	1	100	324.0	1.85	5	PW	EW
TV06B221J(B)-G	220.0	246.00	272.00	1	100	356.0	1.69	5	PX	EX
TV06B251J(B)-G	250.0	279.00	309.00	1	100	405.0	1.48	5	PZ	EZ
TV06B301J(B)-G	300.0	335.00	371.00	1	100	486.0	1.23	5	QE	FE
TV06B351J(B)-G	350.0	391.00	432.00	1	100	567.0	1.06	5	QG	FG
TV06B401J(B)-G	400.0	447.00	494.00	1	100	648.0	0.93	5	QK	FK
TV06B441J(B)-G	440.0	492.00	543.00	1	100	713.0	0.84	5	QM	FM

Note:

- 1) Suffix K denotes 10% tolerance devices, suffix J denotes 5% tolerance devices.
- 2) Suffix B after part number to specify bi-directional devices.
- 3) For Bi-Directional devices having V<sub>R</sub> of 10 volts and under, the I<sub>R</sub> limit is double.

# SMD Transient Voltage Suppressor

## Rating and Characteristics Curves (TV06B5V0-G Thru. TV06B441-G)

Fig.1 Pulse Derating Curve

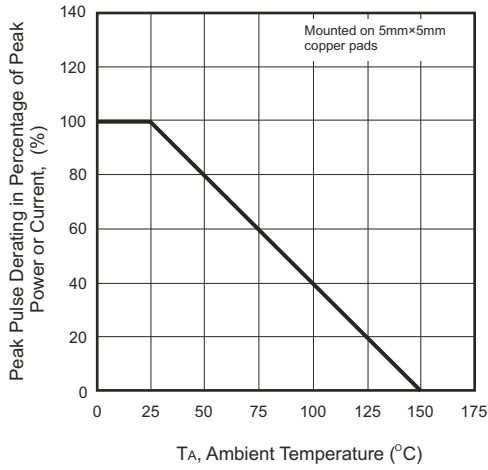

Fig.2 Maximum Non-Repetitive Surge Current

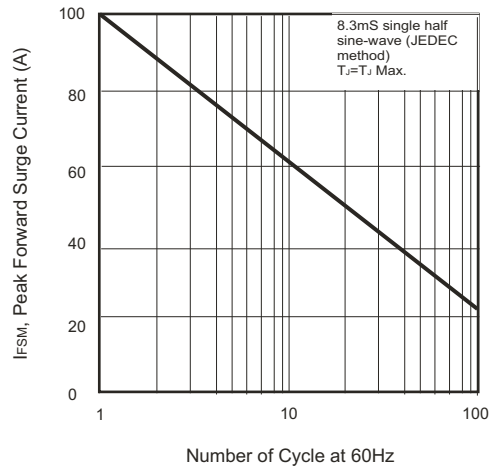

Fig.3 Steady State Power Derating Curve

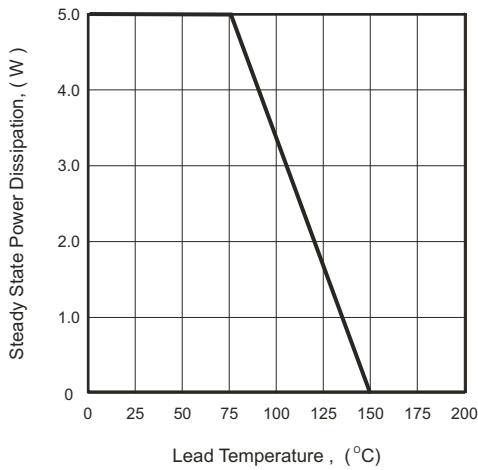

Fig.4 Peak Pulse Power Rating Curve

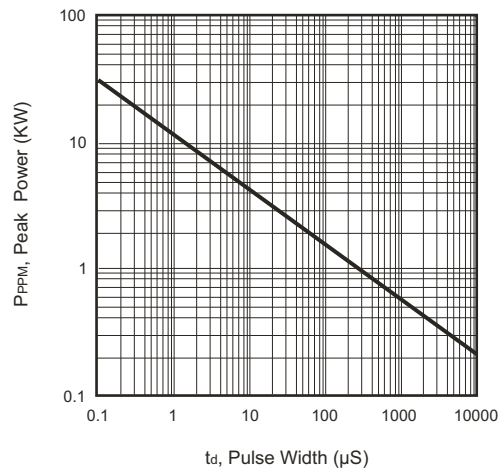

Fig.5 Pulse Waveform

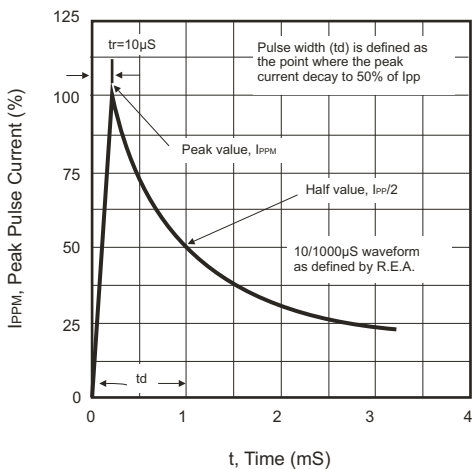
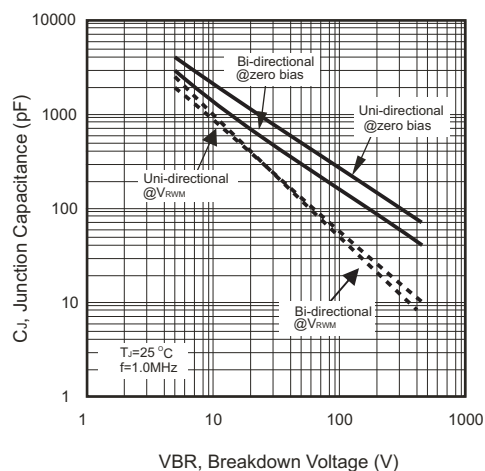
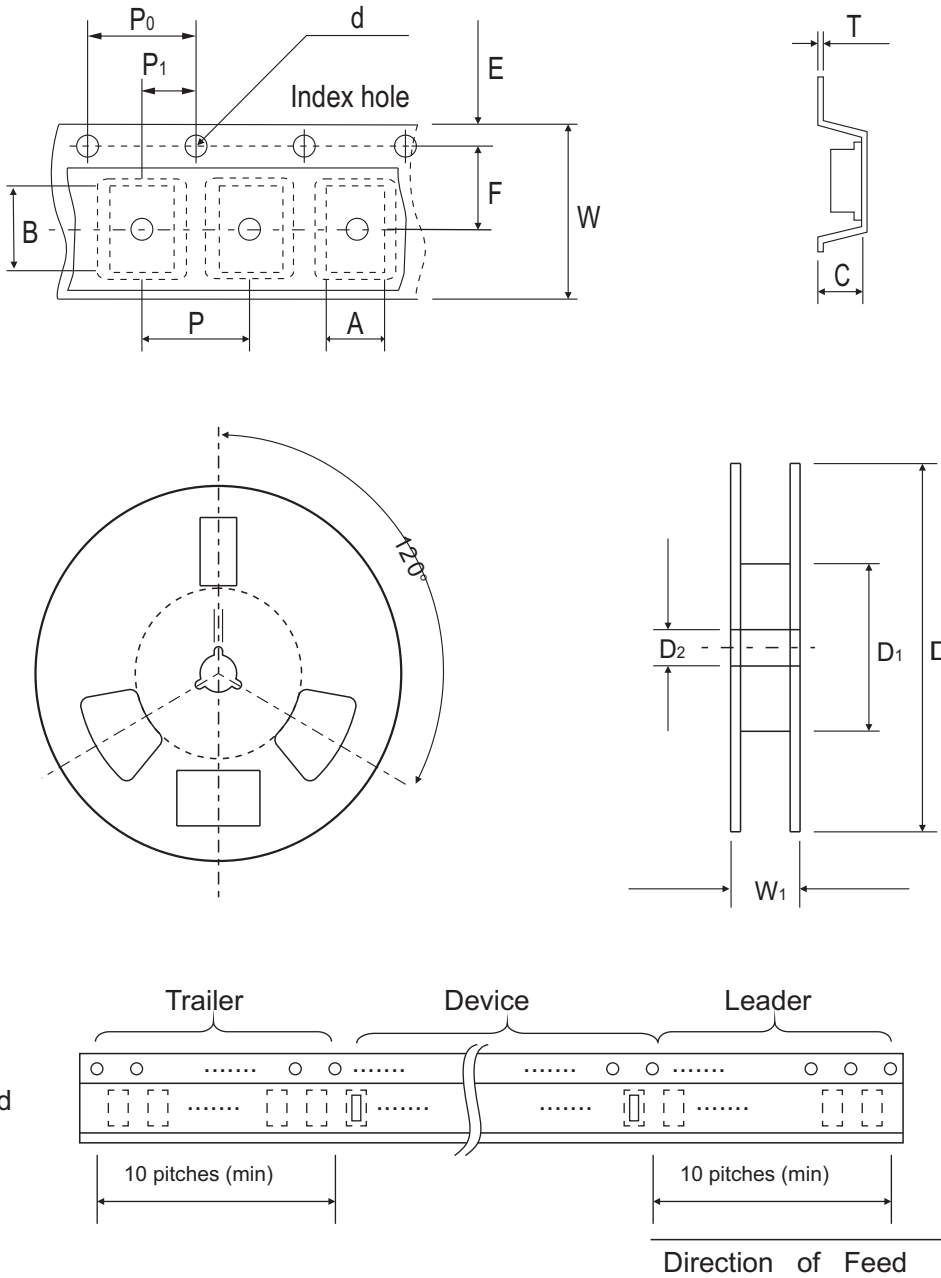

Fig.6 Typical Junction Capacitance



## Reel Taping Specification



DO-214AA (SMB)	SYMBOL	A	B	C	d	D	D1	D2
	(mm)	3.67 ± 0.10	5.69 ± 0.10	4.50 (max)	1.55 ± 0.10	330	50.0 MIN.	13.5 ± 1.00
	(inch)	0.144 ± 0.004	0.224 ± 0.004	0.177 (max)	0.061 ± 0.004	13.00	1.969 MIN.	0.531 ± 0.039

DO-214AA (SMB)	SYMBOL	E	F	P	P0	P1	W	W1
	(mm)	1.75 ± 0.10	5.50 ± 0.05	4.00 ± 0.10	4.00 ± 0.10	2.00 ± 0.05	12.0 ± 0.30	18.4 MAX.
	(inch)	0.689 ± 0.004	0.216 ± 0.002	0.157 ± 0.004	0.157 ± 0.004	0.079 ± 0.002	0.472 ± 0.012	0.724 MAX.

## Marking Code

1. C: COMCHIP
2. ○: Package

○	PKG
A	SMA
B	SMB
C	SMC

3. XX: Marking code(see Page. 2~4)
4. Cathod Band

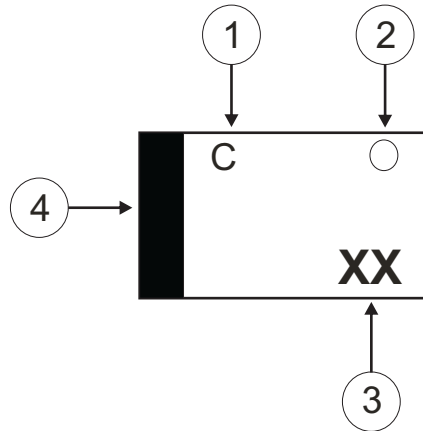

## Suggested PAD Layout

SIZE	DO-214AA (SMB)	
	(mm)	(inch)
A	4.50	0.177
B	1.50	0.059
C	3.60	0.142
D	6.00	1.298
E	3.00	0.118

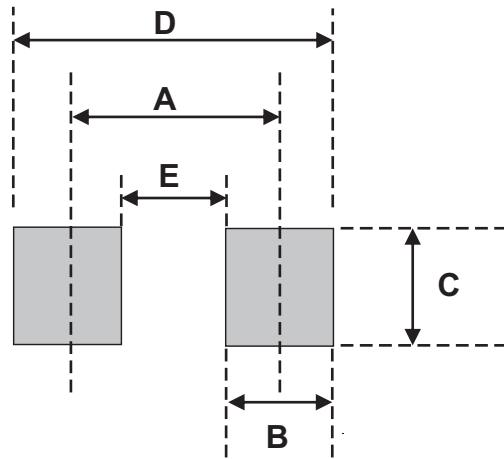

## Standard Packaging

Case Type	Qty per Reel	Reel Size
	(Pcs)	(inch)
DO-214AA (SMB)	3,000	13