

03

031798-1

Circular connectors with threaded joint M16 acc. to IEC 61076-2-106, IP40/IP67/IP68



Chassis plug acc. to IEC 61076-2-106 and AISG specification, IP 68, with threaded joint and ground contact, for printed circuit boards, for back side mounting

03

031798-1

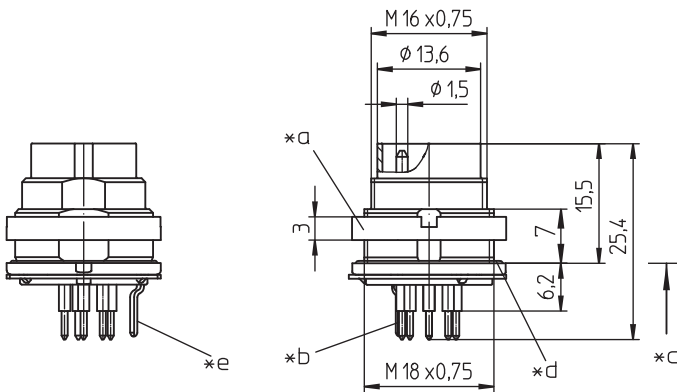
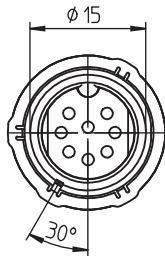
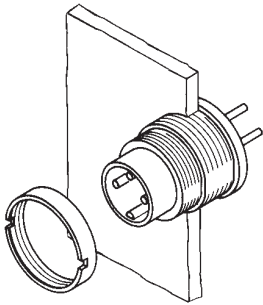

### Environmental conditions

Temperature range -40 °C/+85 °C

### Materials

Insulating body	PA GF, V-0 according to UL94
Contact pin	CuZn, silver-plated and flash gold-plated, tin-plated in solder area
Ground contact	CuZn, pre-nickel and tin-plated
Housing	Zn diecast, pre-copper and nickel-plated
Ring screw	CuZn, nickel-plated
Seal	NBR

### Mechanical data

Protection class IP68<sup>1</sup>







<sup>1</sup> according to IEC DIN EN 60529, only in locked condition with an appropriate counterpart; IPX8 requirements under agreement between manufacturer and user

### Electrical data (at T<sub>amb</sub> 20 °C)





Rated current	5 A (T <sub>amb</sub> 40 °C)
Rated voltage	100 V (with pollution degree 1) 32 V (with pollution degree 2)
Rated impulse voltage	500 V
Material group	II (IEC)/1 (UL) (CTI ≥ 550)
Overvoltage category	I
Insulation resistance	> 100 MΩ

### Associated products

#### Counterparts

 0321	 0322	 0322-1
 032200	 0360	 036000

#### Accessories

 0383	 038399	 0384
 0385	 038899	

03

031798-1

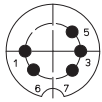
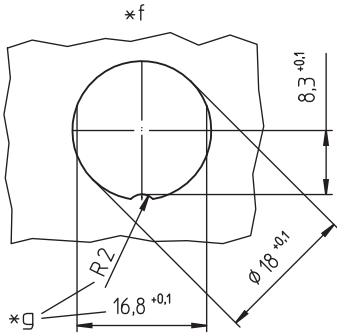
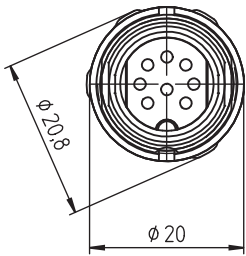

\*h

031798-1 05-3

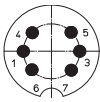

-

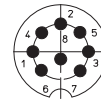

08-a

031798-1 08-1

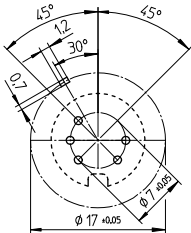

\*h

031798-1 05-3

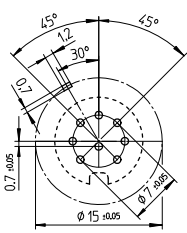

08-a

031798-1 08-1

03

031798-1

- 
- \*a nut enclosed separately
  - \*b for bore hole in printed circuit board  $\varnothing$  1 mm
  - \*c mounting direction
  - \*d O-ring gasket
  - \*e ground contact
  - \*f port in mounting plate
  - \*g anti-rotation, alternative execution
  - \*h pin configuration according to AISG C485

03

031798-1

Designation	Pole Number	PU (Pieces)	MDQ (Pieces)
031798-1 05-3	5	50	
031798-1 08-1	8	50	100

**Packaging:**

in a cardboard box