

## Card Edge Connectors 0.100" (2.54mm) Pitch

### Features:

- 0.100" (2.54mm) contact spacing x 0.300" (7.62mm) row spacing
- Accepts 0.125" (3.18mm) nominal thickness P.C. board
- Contact termination options include P.C. tail, wire hole and 0.025" (0.64mm) square wire wrap
- High profile insulator body 0.600" (15.24mm)
- Single or dual row configurations
- Variety of mounting options
- Accepts in-contact polarizing keys
- Automatic wire wrap positioning holes
- RoHS Compliant

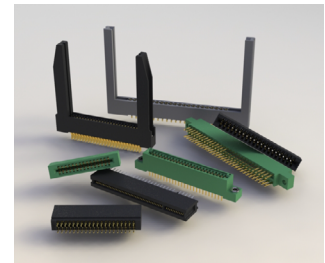

### Specifications:

Insulator Material	UL 94V-0 Diallyl Phthalate, Green Color
Contact Material	Copper Alloy
Contact Plating	Gold Plating on mating area and Tin Plating on tails with Nickel underplating all over
Current Rating	3 amps
Contact Resistance	10 milliohms maximum
Dielectric Withstanding Voltage	1200 V AC rms at sea level between adjacent contacts
Insulation Resistance	5000 megaohms minimum
Operating Temperature	-65°C to +125°C
Insertion Force	16 oz (4.45 N) maximum per contact pair when tested with .135" (3.43mm) thick gauge
Withdrawal Force	1 oz (0.28 N) minimum per contact pair when tested with .115" (2.92mm) thick gauge

Example Part Number: **325-122-520-209**



#### Series:

325

#### Total Number of Contacts:

005, 006, . . . . 061

010, 012, . . . . 122

#### Contact Code: Description:

500 Wire Hole .050 x .025 (1.27 x 0.64) .260 (6.60)

520 P.C. Tail .025 Square (0.64 Square) .175 (4.45)

540 Wire Wrap .025 Square (0.64 Square) .560 (14.22)

#### Contact Rows: Description:

1 Single Row

2 Dual Row

#### Mounting Options: Description:

01 No Mounting Lug

07 M3-0.5 Metric Threaded Inserts

08 #4-40 Unified Threaded Inserts

09 Ø.160" (Ø4.06mm) Mounting Holes

### IN-CONTACT POLARIZING KEY P/N 325-240-328

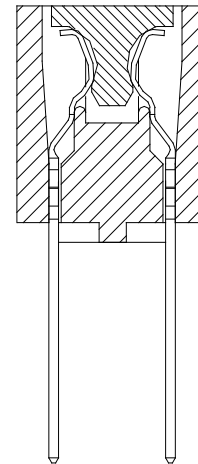

#### Ordering Code Notes:

1) All connector sizes up to 61 contacts single row / 122 contacts dual row are available upon request.

2) For details of the mounting options, refer to next pages.

## Card Edge Connectors 0.100" (2.54mm) Pitch

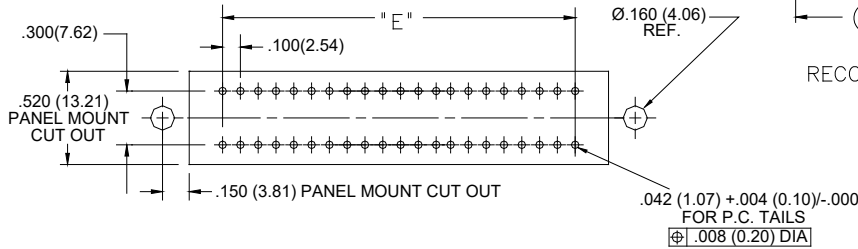
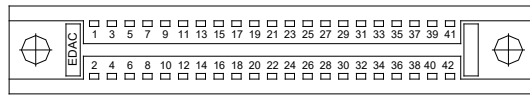
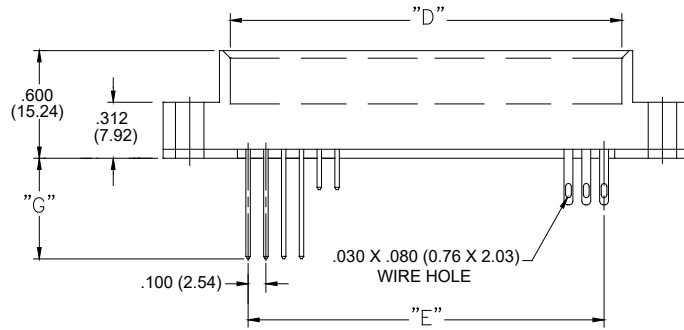
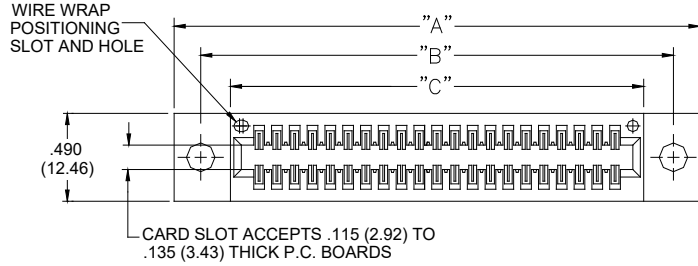

CONNECTOR MOUNTING PATTERN

SECTION THROUGH CONTACT POSITION

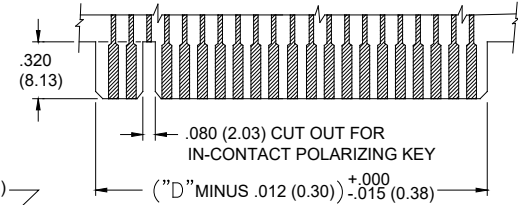
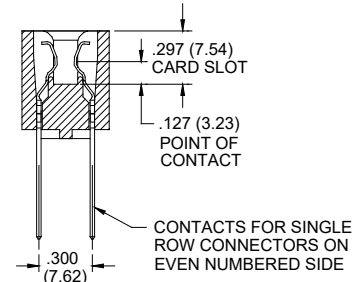

RECOMMENDED DAUGHTER BOARD

CODE X09 - THROUGH MTG. HOLES		
"A" DIA.		CODE X09 0.160(4.06)
CODE X07 AND X08- THREADED INSERTS		
	CODE X07	CODE X08
INSERT	M3-0.5(METRIC)	#4-40 UNC

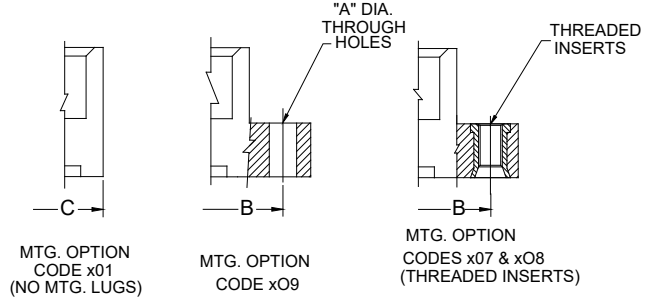

NUMBER OF CONTACTS		"A"		"B"		"C"		"D"		"E"	
Single	Double	Inch	mm	Inch	mm	Inch	mm	Inch	mm	Inch	mm
5	10	1.355	34.42	1.056	26.82	0.722	18.34	0.600	15.24	0.400	10.16
15	30	2.355	59.82	2.056	52.22	1.722	43.74	1.600	40.64	1.400	35.56
18	36	2.655	67.44	2.356	59.84	2.022	51.36	1.900	48.26	1.700	43.18
22	44	3.055	77.60	2.756	70.00	2.422	61.52	2.300	58.42	2.100	53.34
15	30	3.355	85.22	3.056	77.62	2.722	69.14	2.600	66.04	2.400	60.96
30	60	3.855	97.92	3.556	90.32	3.222	81.84	3.100	78.74	2.900	73.66
36	72	4.455	113.16	4.156	105.56	3.822	97.08	3.700	93.98	3.500	88.90
40	80	4.855	123.32	4.556	115.72	4.222	107.24	4.100	104.14	3.900	99.06
43	86	5.155	130.94	4.856	123.34	4.522	114.86	4.400	111.76	4.200	106.68
50	100	5.855	148.72	5.556	141.12	5.222	132.64	5.100	129.54	4.900	124.46
61	122	6.955	176.66	6.656	169.06	6.322	160.58	6.200	157.48	6.000	152.40