

## GaAs PHEMT MMIC 1 WATT POWER AMPLIFIER, 10.0 - 13.0 GHz

### Typical Applications

The HMC592 is ideal for use as a power amplifier for:

- Point-to-Point Radios
- Point-to-Multi-Point Radios
- Test Equipment & Sensors
- Military End-Use
- Space

### Features

- Saturated Output Power:  
+31 dBm @ 21% PAE
- Output IP3: +38 dBm
- Gain: 19 dB
- DC Supply: +7.0 V @ 750 mA
- 50 Ohm Matched Input/Output
- Die Size: 2.47 mm x 1.17 mm x 0.1 mm

### Functional Diagram

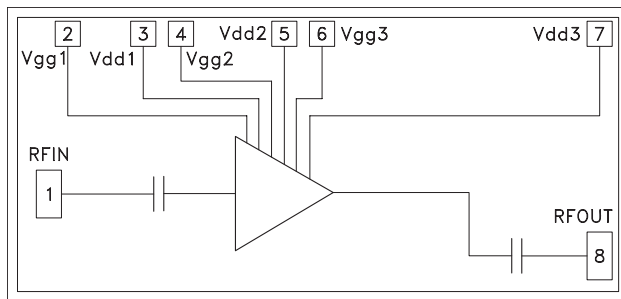

### General Description

The HMC592 is a high dynamic range GaAs PHEMT MMIC 1 Watt Power Amplifier which operates from 10 to 13 GHz. This amplifier die provides 19 dB of gain and +31 dBm of saturated power, at 21% PAE from a +7.0V supply. The RF I/Os are DC blocked and matched to 50 Ohms for ease of integration into Multi-Chip-Modules (MCMs). All data is taken with the chip in a 50 ohm test fixture connected via 0.025mm (1 mil) diameter wire bonds of length 0.31mm (12 mils). For applications which require optimum OIP3, I<sub>dd</sub> should be set for 400 mA, to yield +38 dBm OIP3. For applications which require optimum output P1dB, I<sub>dd</sub> should be set for 750 mA, to yield +31 dBm Output P1dB.

### Electrical Specifications, T<sub>A</sub> = +25° C, V<sub>dd</sub> = +7V, I<sub>dd</sub> = 750 mA\*

Parameter	Min.	Typ.	Max.	Units
Frequency Range	10 - 13			GHz
Gain	16	19		dB
Gain Variation Over Temperature		0.05		dB/°C
Input Return Loss		10		dB
Output Return Loss		12		dB
Output Power for 1 dB Compression (P1dB)	28	31		dBm
Saturated Output Power (Psat)		31.2		dBm
Output Third Order Intercept (IP3) <sup>[2]</sup>		38		dBm
Supply Current (I <sub>dd</sub> )		750	800	mA

[1] Adjust V<sub>gg</sub> between -2 to 0V to achieve I<sub>dd</sub>= 750 mA typical.

[2] Measurement taken at 7V @ 400mA, Pin / Tone = -15 dBm

**GaAs PHEMT MMIC 1 WATT  
POWER AMPLIFIER, 10.0 - 13.0 GHz**

**Broadband Gain & Return Loss**

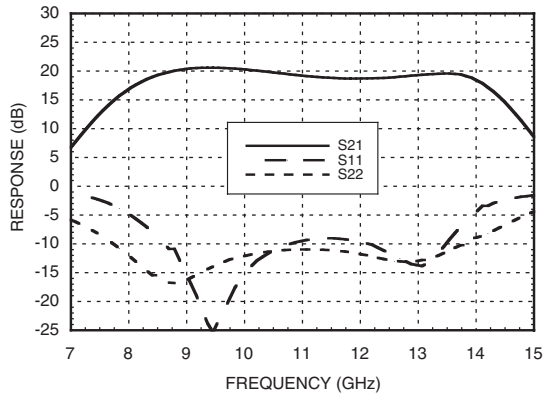

**Gain vs. Temperature**

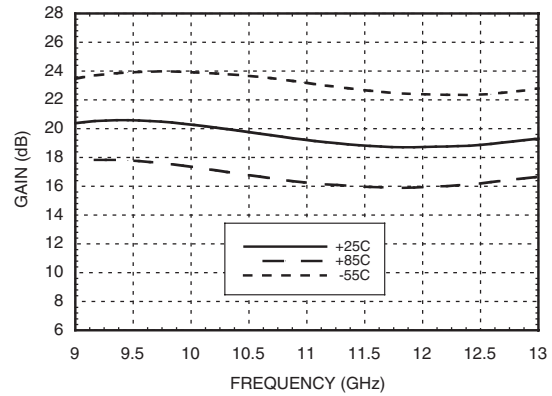

**Input Return Loss vs. Temperature**

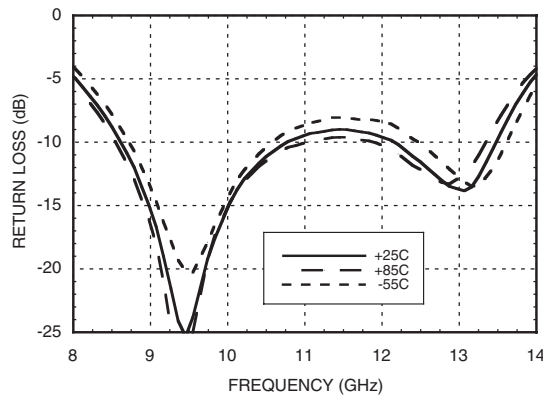

**Output Return Loss vs. Temperature**

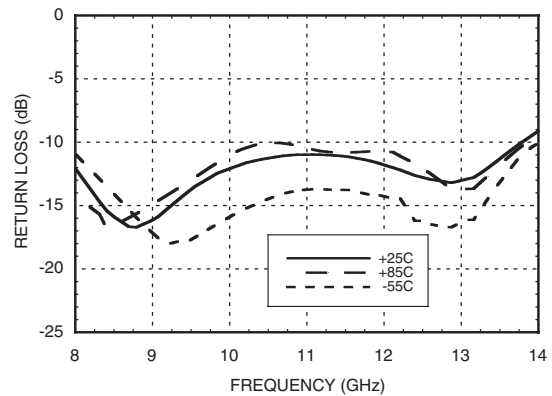

**P1dB vs. Temperature**

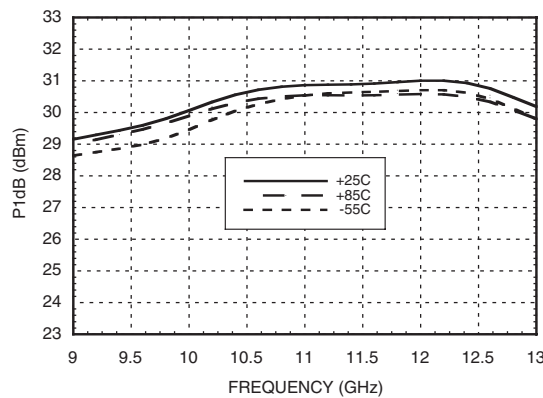

**Psat vs. Temperature**

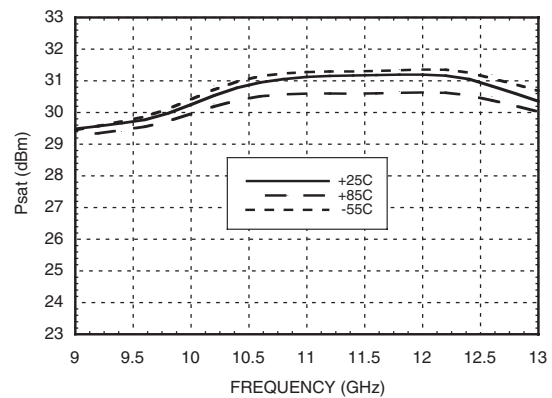

## GaAs PHEMT MMIC 1 WATT POWER AMPLIFIER, 10.0 - 13.0 GHz

1

AMPLIFIERS - CHIP

**P1dB vs. Current**

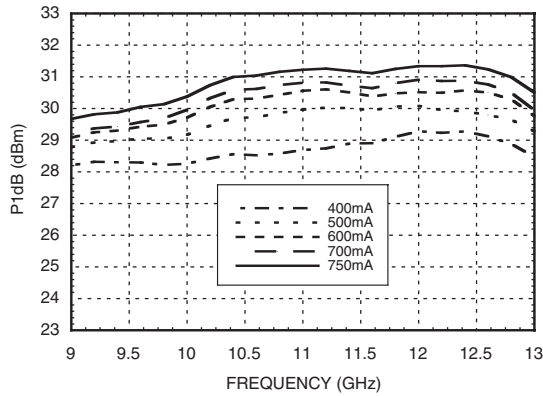

**Psat vs. Current**

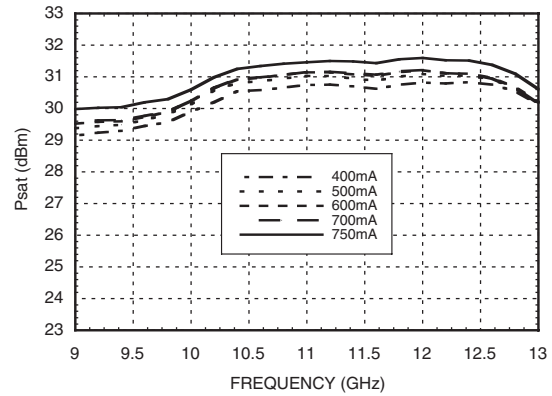

**Output IP3 vs. Temperature  
7V @ 400 mA, Pin/Tone = -15 dBm**

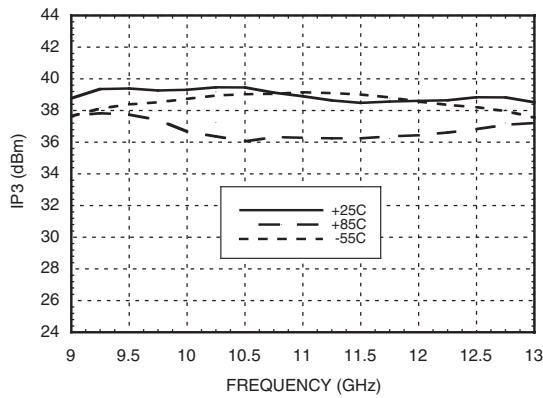

**Power Compression @ 8 GHz, 7V @ 750 mA**

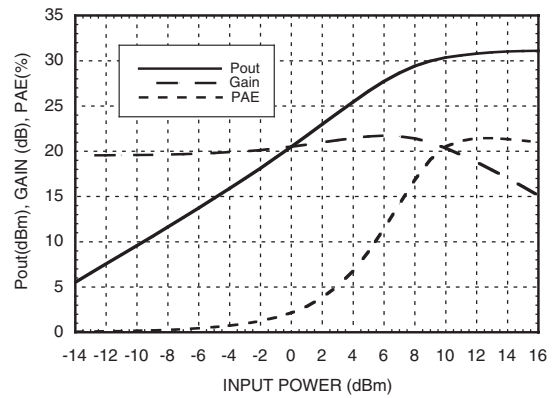

**Output IM3, 7V @ 400 mA**

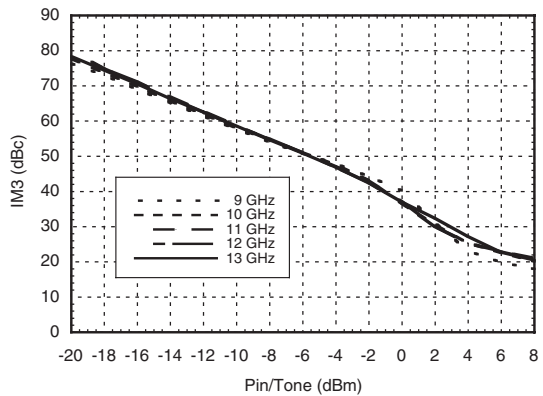

**Output IM3, 7V @ 750 mA**

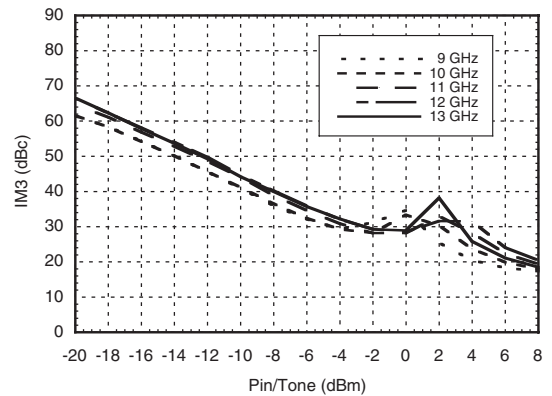

**GaAs PHEMT MMIC 1 WATT  
POWER AMPLIFIER, 10.0 - 13.0 GHz**

**Gain & Power vs. Supply Current @ 8 GHz**

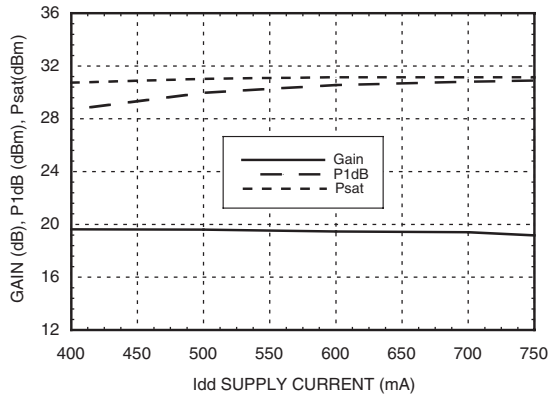

**Gain & Power vs. Supply Voltage @ 8 GHz**

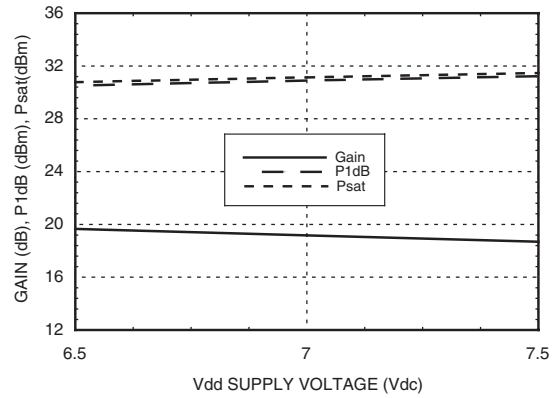

**Reverse Isolation vs. Temperature**

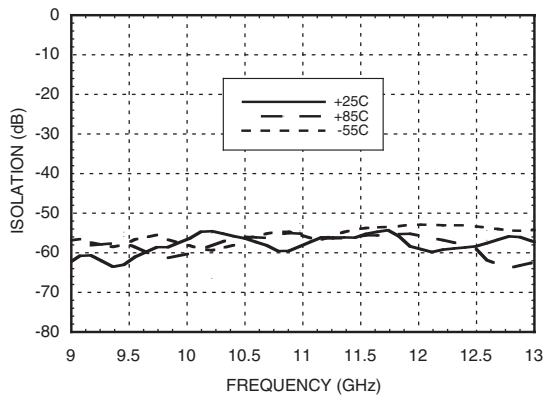

**Power Dissipation**

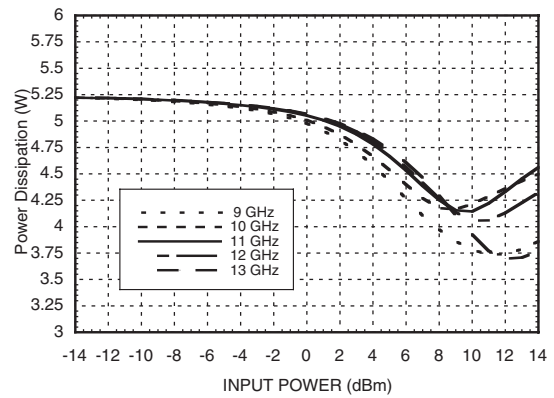

**GaAs PHEMT MMIC 1 WATT  
POWER AMPLIFIER, 10.0 - 13.0 GHz**

**Absolute Maximum Ratings**

Drain Bias Voltage (Vdd)	+8 Vdc
Gate Bias Voltage (Vgg)	-2.0 to 0 Vdc
RF Input Power (RFIn)(Vdd = +7.0 Vdc)	+15 dBm
Channel Temperature	175 °C
Continuous Pdiss (T= 85 °C) (derate 62.7 mW/°C above 85 °C)	5.64 W
Thermal Resistance (channel to die bottom)	15.94 °C/W
Storage Temperature	-65 to +150 °C
Operating Temperature	-55 to +85 °C

**Typical Supply Current vs. Vdd**

Vdd (V)	Idd (mA)
+6.5	757
+7.0	750
+7.5	745

Note: Amplifier will operate over full voltage ranges shown above Vgg adjusted to achieve Idd = 750 mA at +7.0V



**ELECTROSTATIC SENSITIVE DEVICE  
OBSERVE HANDLING PRECAUTIONS**

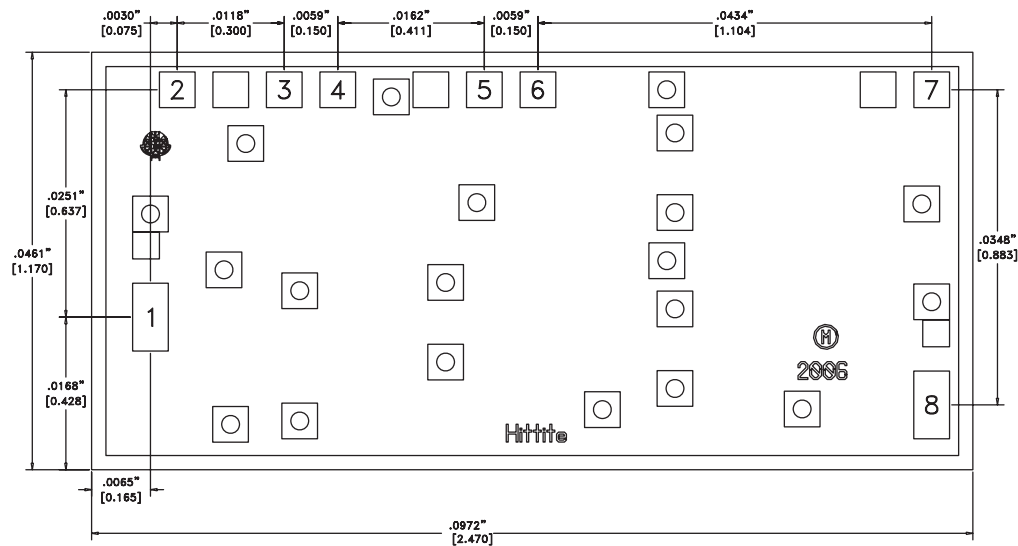

**Die Packaging Information [1]**

Standard	Alternate
GP-1	[2]

[1] Refer to the "Packaging Information" section for die packaging dimensions.

[2] For alternate packaging information contact Hittite Microwave Corporation.

**NOTES:**

1. ALL DIMENSIONS ARE IN INCHES [MM]
2. DIE THICKNESS IS .004"
3. TYPICAL BOND PAD IS .004" SQUARE
4. BACKSIDE METALLIZATION: GOLD
5. BOND PAD METALLIZATION: GOLD
6. BACKSIDE METAL IS GROUND.
7. CONNECTION NOT REQUIRED FOR UNLABELED BOND PADS.
8. OVERALL DIE SIZE ± .002

**GaAs PHEMT MMIC 1 WATT  
POWER AMPLIFIER, 10.0 - 13.0 GHz**

**Pad Descriptions**

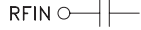
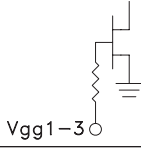
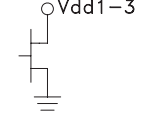
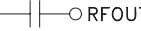
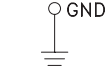
Pad Number	Function	Description	Interface Schematic
1	RFIN	This pad is AC coupled and matched to 50 Ohms.	
2, 4, 6	Vgg 1-3	Gate control for amplifier. Adjust to achieve I <sub>dd</sub> of 750 mA. Please follow "MMIC Amplifier Biasing Procedure" Application Note. External bypass capacitors of 100 pF and 0.1 μF are required.	
3, 5, 7	Vdd 1-3	Power Supply Voltage for the amplifier. External bypass capacitors of 100 pF and 0.1 μF are required.	
8	RFOUT	This pad is AC coupled and matched to 50 Ohms.	
Die Bottom	GND	Die bottom must be connected to RF/DC ground.	

**GaAs PHEMT MMIC 1 WATT  
POWER AMPLIFIER, 10.0 - 13.0 GHz**

1

AMPLIFIERS - CHIP

**Assembly Diagram**

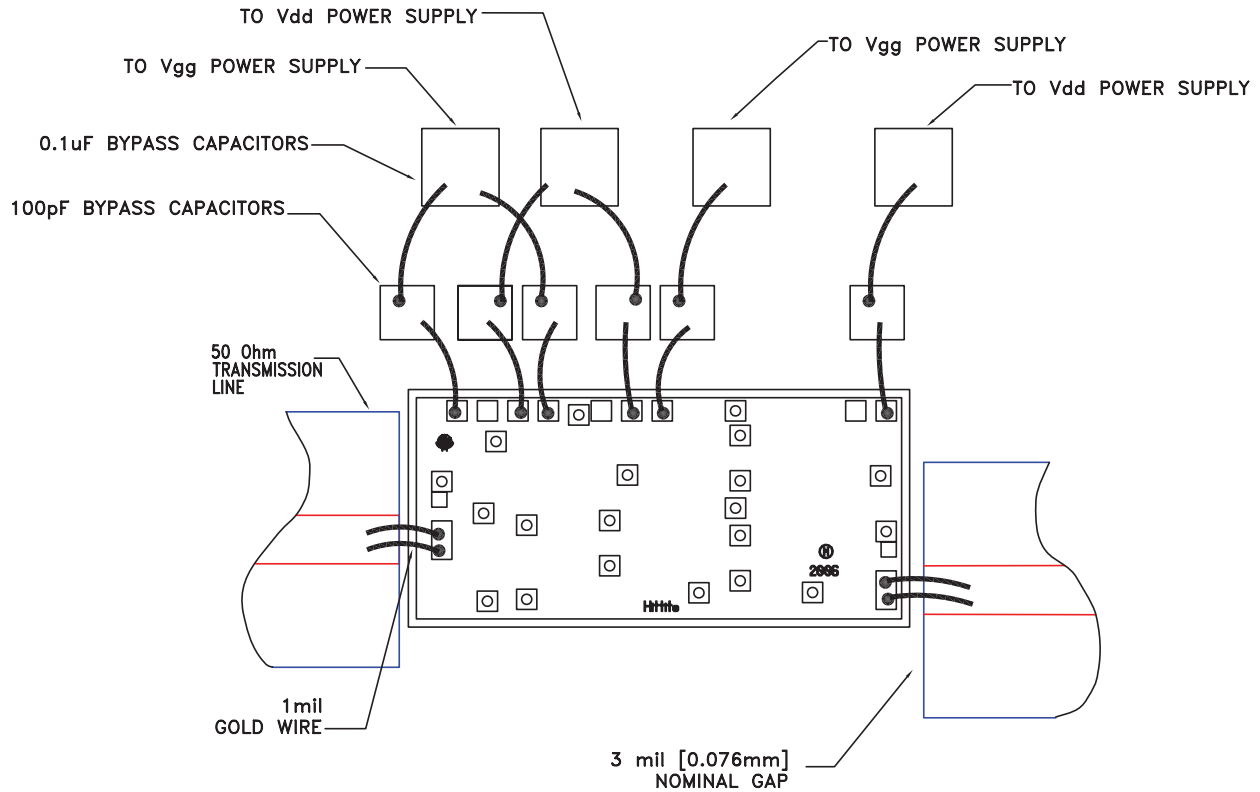

**GaAs PHEMT MMIC 1 WATT  
POWER AMPLIFIER, 10.0 - 13.0 GHz**

**Mounting & Bonding Techniques for Millimeterwave GaAs MMICs**

The die should be attached directly to the ground plane eutectically or with conductive epoxy (see HMC general Handling, Mounting, Bonding Note).

50 Ohm Microstrip transmission lines on 0.127mm (5 mil) thick alumina thin film substrates are recommended for bringing RF to and from the chip (Figure 1). If 0.254mm (10 mil) thick alumina thin film substrates must be used, the die should be raised 0.150mm (6 mils) so that the surface of the die is coplanar with the surface of the substrate. One way to accomplish this is to attach the 0.102mm (4 mil) thick die to a 0.150mm (6 mil) thick molybdenum heat spreader (moly-tab) which is then attached to the ground plane (Figure 2).

Microstrip substrates should be located as close to the die as possible in order to minimize bond wire length. Typical die-to-substrate spacing is 0.076mm to 0.152 mm (3 to 6 mils).

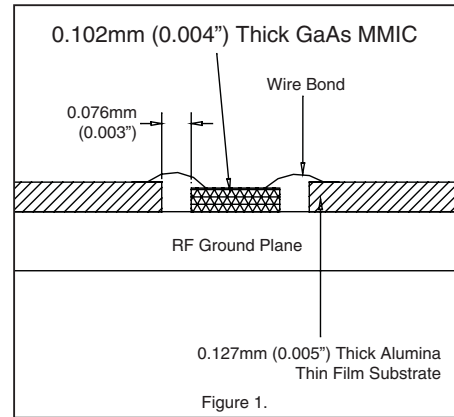

**Handling Precautions**

Follow these precautions to avoid permanent damage.

**Storage:** All bare die are placed in either Waffle or Gel based ESD protective containers, and then sealed in an ESD protective bag for shipment. Once the sealed ESD protective bag has been opened, all die should be stored in a dry nitrogen environment.

**Cleanliness:** Handle the chips in a clean environment. DO NOT attempt to clean the chip using liquid cleaning systems.

**Static Sensitivity:** Follow ESD precautions to protect against > ± 250V ESD strikes.

**Transients:** Suppress instrument and bias supply transients while bias is applied. Use shielded signal and bias cables to minimize inductive pick-up.

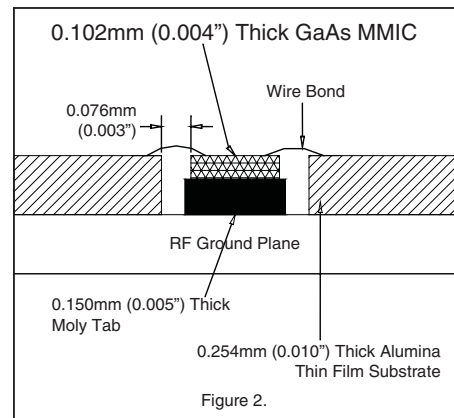

**General Handling:** Handle the chip along the edges with a vacuum collet or with a sharp pair of bent tweezers. The surface of the chip has fragile air bridges and should not be touched with vacuum collet, tweezers, or fingers.

**Mounting**

The chip is back-metallized and can be die mounted with AuSn eutectic preforms or with electrically conductive epoxy. The mounting surface should be clean and flat.

**Eutectic Die Attach:** A 80/20 gold tin preform is recommended with a work surface temperature of 255 deg. C and a tool temperature of 265 deg. C. When hot 90/10 nitrogen/hydrogen gas is applied, tool tip temperature should be 290 deg. C. DO NOT expose the chip to a temperature greater than 320 deg. C for more than 20 seconds. No more than 3 seconds of scrubbing should be required for attachment.

**Epoxy Die Attach:** Apply a minimum amount of epoxy to the mounting surface so that a thin epoxy fillet is observed around the perimeter of the chip once it is placed into position. Cure epoxy per the manufacturer's schedule.

**Wire Bonding**

Ball or wedge bond with 0.025mm (1 mil) diameter pure gold wire. Thermosonic wirebonding with a nominal stage temperature of 150 deg. C and a ball bonding force of 40 to 50 grams or wedge bonding force of 18 to 22 grams is recommended. Use the minimum level of ultrasonic energy to achieve reliable wirebonds. Wirebonds should be started on the chip and terminated on the package or substrate. All bonds should be as short as possible <0.31mm (12 mils).