

MIL-STD-1553 Transformers

Low profile 3.3V Pulse Transformers

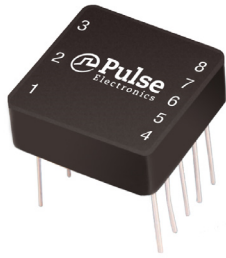

- ⊕ Dual ratio in a single transformer package (see Schematic)
- ⊕ Operating and Storage Temperature: -55 °C to +125 °C
- ⊕ Weight: ≤5.0 grams
- ⊕ Applicable specifications
 - MIL-STD-1553B
 - MIL-PRF-21038
 - MIL-STD-202
 - ISO 9001

⊕ Maximum Reflow Temperature for SMT parts: 235 deg C

Electrical Specifications @ 25°C										
Part Number	Terminals	Ratio (±3%)	DC Resistance (Ω MAX)	Impedance (Ω MIN)	Drop	Overshoot	CMR	Frequency Range (No Load)	IR @ 250Vdc (MIN)	DWV
Q1553-70	1-3:4-8 1-3:5-7	1.0CT:3.0CT 1.0CT:2.15CT	1-3 = 0.35 4-8 = 3.50	4-8 4000	20% MAX	±1V MIN	45db MIN	75kHz to 1MHz	10K MΩ	100 Vrms
SMQ1553-70	1-3:4-8 1-3:5-7	1CT:3CT 1CT:2.15CT	(1-3) .35 (4-8) 3.5	4-8 4000	20% max	±1V MAX	45dB MIN	75kHz to 1MHz	10K MΩ	100 Vrms
GL1553-71	1-3:4-8 1-3:5-7	1CT:3.54CT 1CT:2.50CT	(1-3) 0.35 (4-8) 3.5	4-8 4000	20% max	±1V MAX	45dB MIN	75kHz to 1MHz	10K MΩ	100 Vrms
DGL1553-71	1-3:1613/5-7:12-9 1-3:15-14/5-7:11-10	1CT:3.54CT 1CT:2.5CT	(1-3),(5-7) 0.35 (16-13),(12-9) 3.5	16-13 & 12-9 4000	20% max	±1V MAX	45dB MIN	75kHz to 1MHz	10K MΩ	100 Vrms
TQ1553-71	1-3:4-8 1-3:5-7	1CT:3.54CT 1CT:2.5CT	(1-3) 0.35 (4-8) 3.5	4-8 4000	20% max	±1V MAX	45dB MIN	75kHz to 1MHz	10K MΩ	100 Vrms

Mechanical

Schematic

Q1553-70

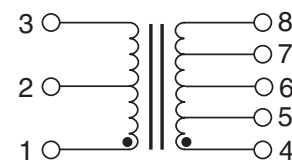
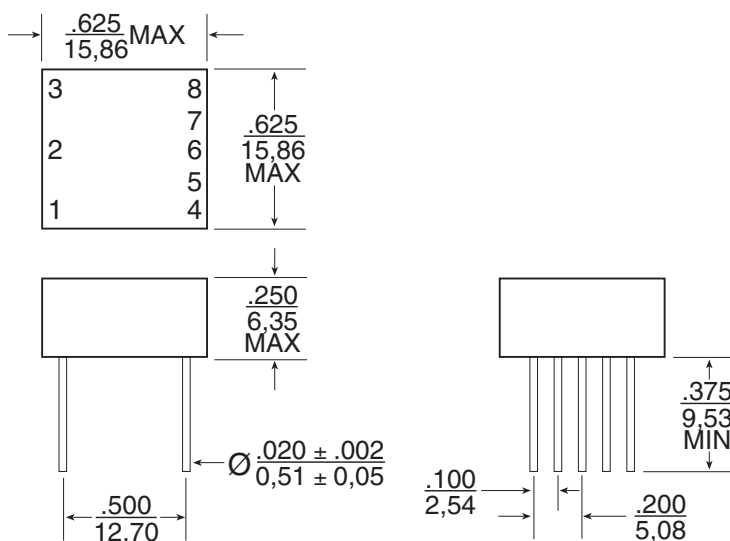

Notes:

1. All dimensions are in inches.
2. Tolerances: .xx = +.008
3. All specifications and dimensions are subject to change without notice.
4. MSL - 1
5. Tube - 20 pieces

MIL-STD-1553 Transformers

Low profile 3.3V Pulse Transformers



Mechanical

Schematic

SMQ1553-70

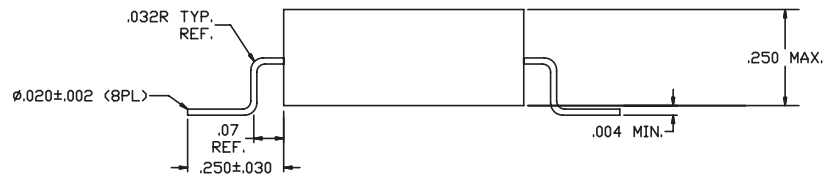
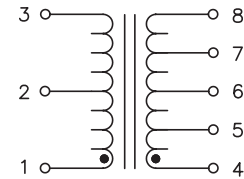
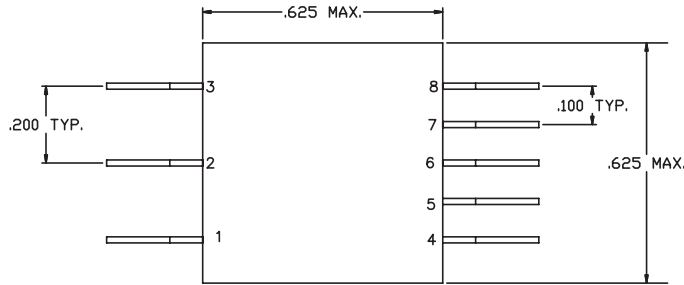

Notes:

1. All dimensions are in inches.
2. Tolerances: .xx = +.008
3. All specifications and dimensions are subject to change without notice.
4. MSL – 3
5. Tape & Reel Size – 300

Mechanical

Schematic

GL1553-71

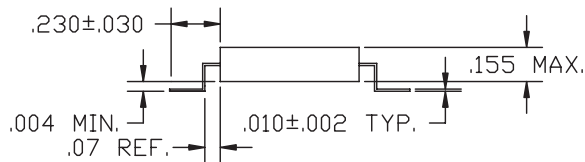
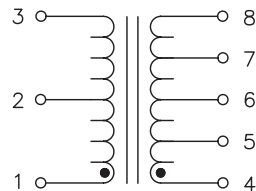
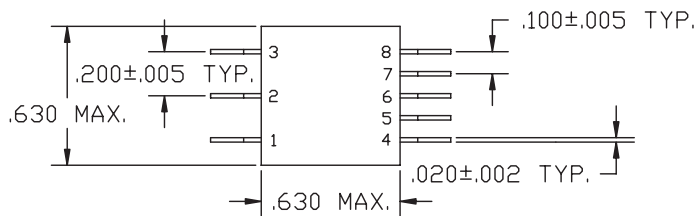

Notes:

1. All dimensions are in inches.
2. Tolerances: .xx = +.008
3. All specifications and dimensions are subject to change without notice.
4. MSL – 3
5. Tape & Reel Size – 350

MIL-STD-1553 Transformers

Low profile 3.3V Pulse Transformers



Mechanical

Schematic

DGL1553-71

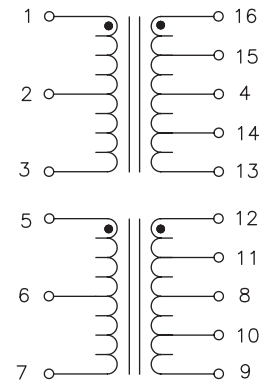
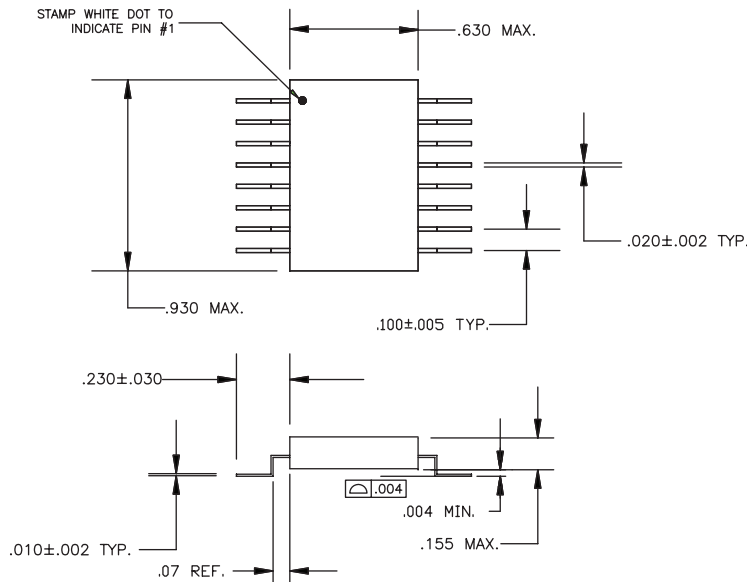

Notes:

1. All dimensions are in inches.
2. Tolerances: .xx = +.008
3. All specifications and dimensions are subject to change without notice.
4. MSL - 3
5. Tape & Reel Size - 300

Mechanical

Schematic

TQ1553-71

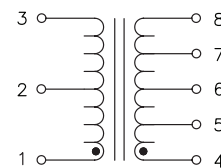
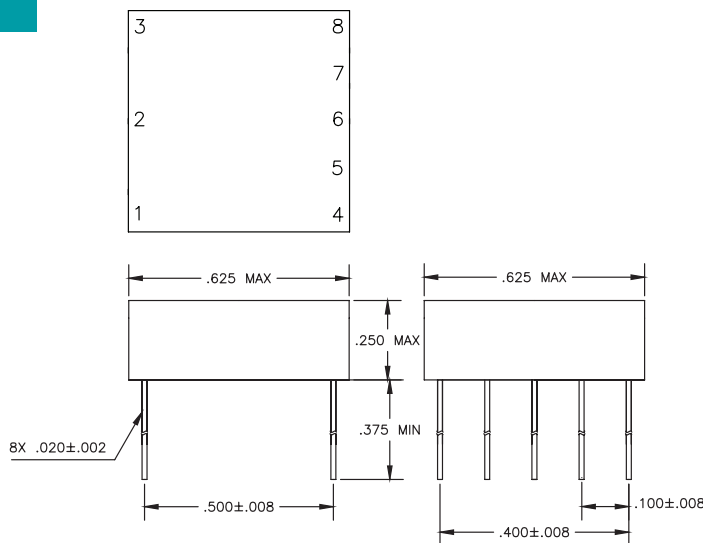

Notes:

1. All dimensions are in inches.
2. Tolerances: .xx = +.008
3. All specifications and dimensions are subject to change without notice.
4. MSL - 1
5. Tube - 20 pieces

For More Information

Pulse North America Headquarters
Two Pearl Buck Court
Bristol, PA 19007
U.S.A.

Pulse Europe
Zeppelinstrasse 15
71083 Herrenberg
Germany

Pulse China Headquarters
B402, Shenzhen Academy of
Aerospace Technology Bldg.
10th Kejian Road
High-Tech Zone
Nanshan District
Shenzhen, PR China 518057
Tel: 86 755 33966678
Fax: 86 755 33966700

Pulse North China
Room 2704/2705
Super Ocean Finance Ctr.
2067 Yan An Road West
Shanghai 200336
China
Tel: 86 21 62787060
Fax: 86 21 62786973

Pulse South Asia
135 Joo Seng Road
#03-02
PM Industrial Bldg.
Singapore 368363

Pulse North Asia
3F No. 198, Zhongyuan Road
Zhongli City
Taoyuan County (32068)
Taiwan
Tel: 886 3 4356768
Fax: 886 3 4356823

Tel: 215 781 6400
Fax: 215 781 6403

Tel: 49 7032 7806 0
Fax: 49 7032 7806 12

Tel: 65 6287 8998
Fax: 65 6287 8998

Tel: 886 3 4356768
Fax: 886 3 4356823

Performance warranty of products offered on this data sheet is limited to the parameters specified. Data is subject to change without notice. Other brand and product names mentioned herein may be trademarks or registered trademarks of their respective owners. © Copyright, 2013. Pulse Electronics, Inc. All rights reserved.