

Rev	AWO #	Description	Date	Appr
-		RELEASED	7/7/04	

APPROVED: _____
 DATE: _____ TITLE: _____

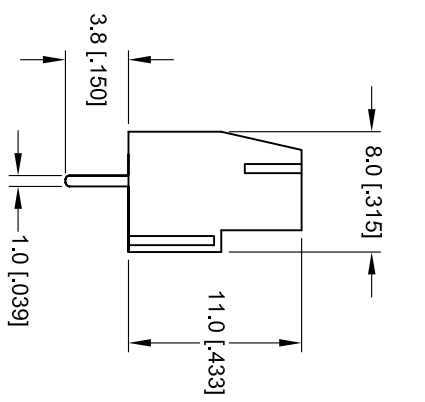
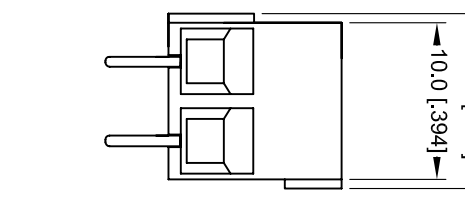
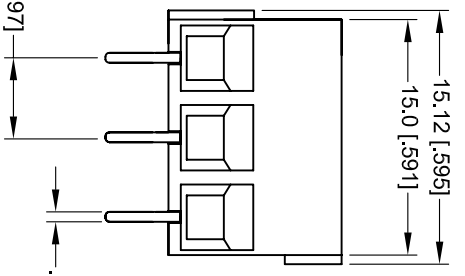
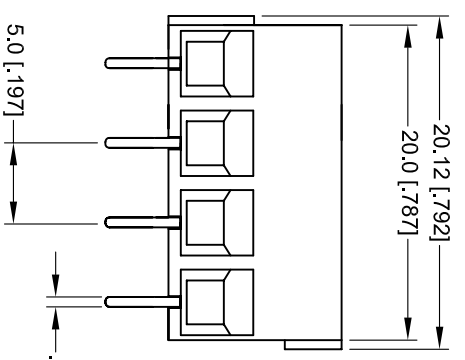
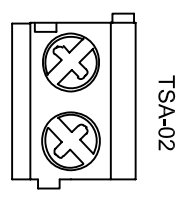
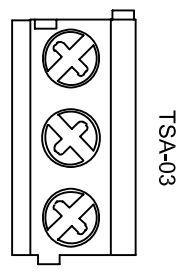
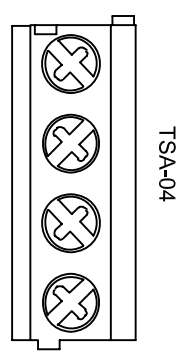

SPECIFICATIONS:

Material: Insulator: Thermoplastic, Rated UL94V-0

Insulator color: Green

Terminals: Brass, Tin Plated

Screws: Steel, Zinc Plated.

Electrical: Operation voltage: 300 VAC

Current rating: 10A

Insulation resistance: 500 Mohms @ 500 VDC.

Dielectric withstanding voltage: 2000 VAC / Min.

Wire Range: 16 To 22 Awg

Environmental:
 Lead free, RoHS compliant.
 Recommended soldering temp: 235°C for 5 sec.

ADAM TECH
 909 Rahway Avenue, Union, NJ 07083
 Phone: 908-687-5000 Fax: 908-687-5710

UNLESS OTHERWISE SPECIFIED
 ALL DIMENSIONS ARE MM [INCHES]
 TOLERANCES: EXCEPT AS NOTED

.X	± .10	ØX	± .10
.XX	± .020	ØXXX	± .015
.XXX	± .015	ØXXXX	± .010

APPROVALS: _____ DATE: _____

DRAWN	SS	7/7/04
CHECKED		
APPROVED		

SIZE	PART NO.	REV.
X	TSA-XX	
REF:	SCALE: NTS	SHEET 1 OF 1



A 6 5 4 3 2 1

A B C D