

PART NUMBER		SML-LXIL2324USBCTR	REV	C
REV	E.C.N. NUMBER AND REVISION COMMENTS		DATE	
A	E.C.N. #10BRDR. & REDRAWN		10.03.13	
B	E.C.N. #11880.		10.03.13	
C	ECN-Lumex201700078		09.25.17	

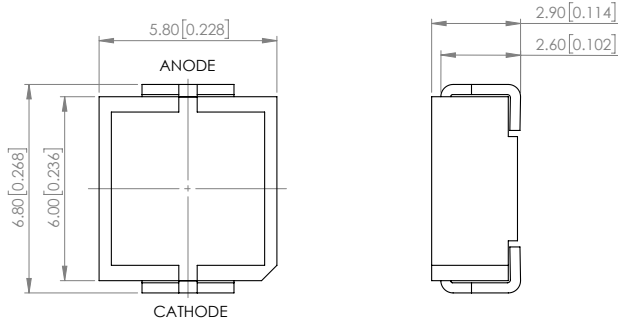

POLARITY

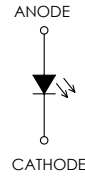

ELECTRO-OPTICAL CHARACTERISTIC TA=25°C

PARAMETER	MIN	TYP	MAX	UNITS	TEST COND
DOMINANT WAVELENGTH	-	470	-	nm	If=20mA
FORWARD VOLTAGE	-	3.4	3.8	Vf	If=20mA
REVERSE CURRENT	-	-	10	uA	Vr=5V
LUMINOUS INTENSITY	-	20000	-	mcd	If=20mA
VIEWING ANGLE	-	8	-	2x theta1/2	-
EMITTED COLOR	BLUE				
EPOXY LENS FINISH	WATER CLEAR				

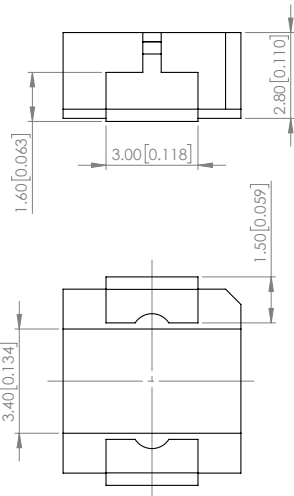

RECOMMENDED SOLDER PAD LAYOUT

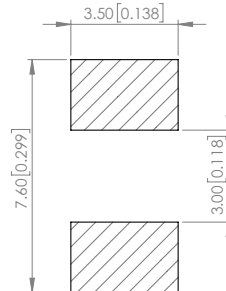

ABSOLUTE MAXIMUM RATINGS TA=25°C

PARAMETER	MAX	UNITS
FORWARD CURRENT	30	mA
REVERSE VOLTAGE	4	V
POWER DISSIPATION	114	mW
STORAGE TEMPERATURE	-30 TO +85	°C
OPERATING TEMPERATURE	-30 TO +85	°C

MOISTURE SENSITIVE DEVICE
PER JEDEC LEVEL 4 STANDARDS

*UNLESS OTHERWISE SPECIFIED TOLERANCES PER DECIMAL PRECISION ARE: X=±1 (±0.039), X.X=±0.5 (±0.020), X.XX=±0.25 (±0.010), X.XXX=±0.127 (±0.005). LEAD SIZE=±0.05 (±0.002), LEAD LENGTH=±0.75 (±0.030), MIN=^{0.00}DECIMAL PRECISION MAX.=^{0.00}DECIMAL PRECISION



425 N. GARY AVE.
CAROL STREAM, IL 60188
PHONE : 800-278-5666
FAX : 630-315-2150
WEB : WWW.LUMEX.COM

6.8(L)*5.8(W)*2.9(H)mm, NARROW BEAM 6mm SMT LED, 470nm BLUE LED, WATER CLEAR LENS, TAPE & REEL.

THE SPECIFICATIONS MAY CHANGE AT ANY TIME WITHOUT NOTICE DUE TO NEW MATERIALS OR PRODUCT IMPROVEMENT.

CONFIDENTIAL INFORMATION
THE INFORMATION CONTAINED IN THIS DOCUMENT IS THE PROPERTY OF LUMEX INC. EXCEPT AS SPECIFICALLY AUTHORIZED IN WRITING BY LUMEX INC., THE HOLDER OF THIS DOCUMENT SHALL KEEP ALL INFORMATION CONTAINED HEREIN CONFIDENTIAL AND SHALL PROTECT SAME IN WHOLE OR IN PART FROM DISCLOSURE AND DISSEMINATION TO ALL THIRD PARTIES.

DATE : 2017.09.25	DRAWN BY : C.C.
PAGE : 1 OF 3	CHKD BY : G.Y.
SCALE : NTF	APRVD BY : E.C.
UNIT : mm [INCH]	Ⓢ

PROFILE

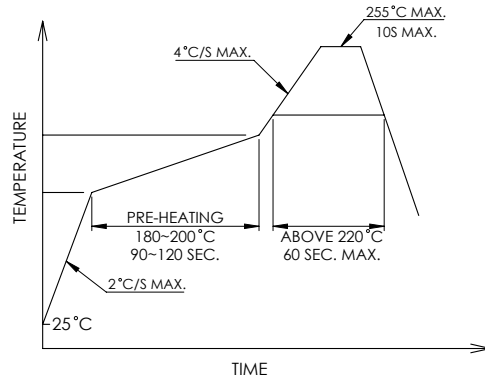

CARRIER TAPE DIMENSION

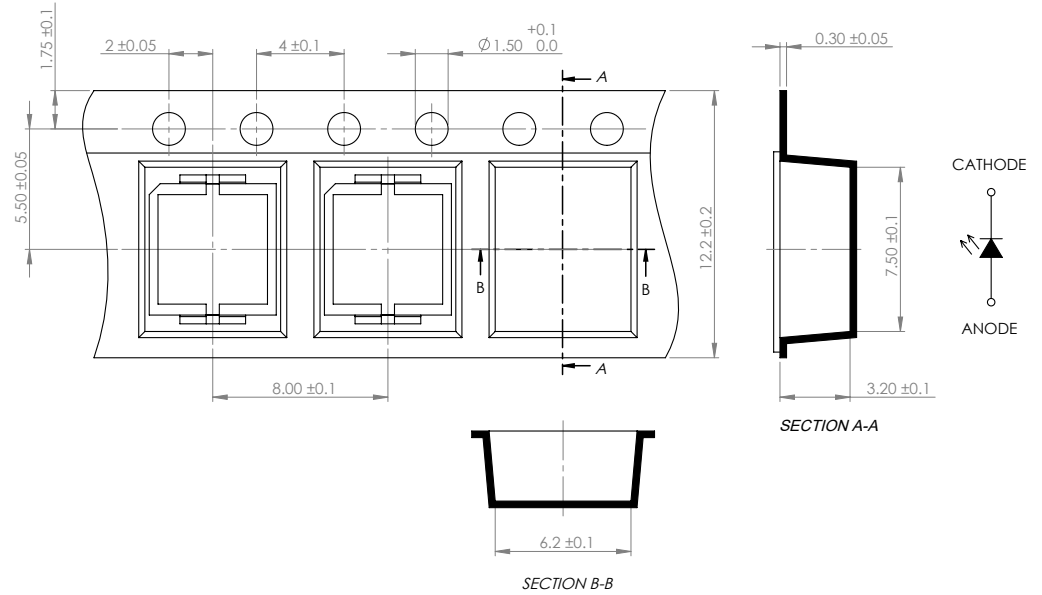

*UNLESS OTHERWISE SPECIFIED TOLERANCES PER DECIMAL PRECISION ARE: X=±1 (±0.039), X.X=±0.5 (±0.020), X.XX=±0.25 (±0.010), X.XXX=±0.127 (±0.005). LEAD SIZE=±0.05 (±0.002), LEAD LENGTH=±0.75 (±0.030), MIN=^{°DECIMAL PRECISION}_{0.00} MAX.=^{°DECIMAL PRECISION}_{0.00}

LUMEX
 Creating LED and LCD Solutions Together™
 425 N. GARY AVE.
 CAROL STREAM, IL 60188
 PHONE : 800-278-5666
 FAX : 630-315-2150
 WEB : WWW.LUMEX.COM

6.8(L)*5.8(W)*2.9(H)mm, NARROW BEAM 6mm SMT LED, 470nm BLUE LED, WATER CLEAR LENS, TAPE & REEL.
****THE SPECIFICATIONS MAY CHANGE AT ANY TIME WITHOUT NOTICE DUE TO NEW MATERIALS OR PRODUCT IMPROVEMENT.****
CONFIDENTIAL INFORMATION
 THE INFORMATION CONTAINED IN THIS DOCUMENT IS THE PROPERTY OF LUMEX INC. EXCEPT AS SPECIFICALLY AUTHORIZED IN WRITING BY LUMEX INC., THE HOLDER OF THIS DOCUMENT SHALL KEEP ALL INFORMATION CONTAINED HEREIN CONFIDENTIAL AND SHALL PROTECT SAME IN WHOLE OR IN PART FROM DISCLOSURE AND DISSEMINATION TO ALL THIRD PARTIES.

DATE : 2017.09.25	DRAWN BY : C.C.
PAGE : 2 OF 3	CHKD BY : G.Y.
SCALE : NTF	APRVD BY : E.C.
UNIT : mm [INCH]	Ⓢ

DIRECTIVITY (TYPICAL)

DIRECTIVITY

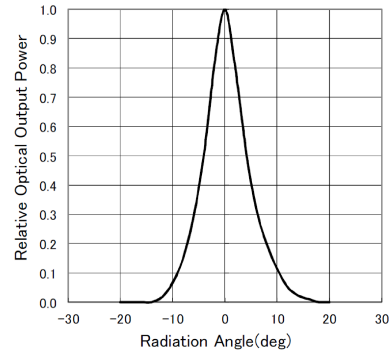

CHARACTERISTICS (TYPICAL)

AMBIENT TEMPERATURE vs. FORWARD CURRENT

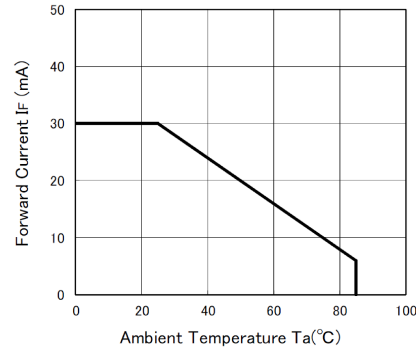

FORWARD CURRENT vs. RELATIVE OPTICAL OUTPUT POWER

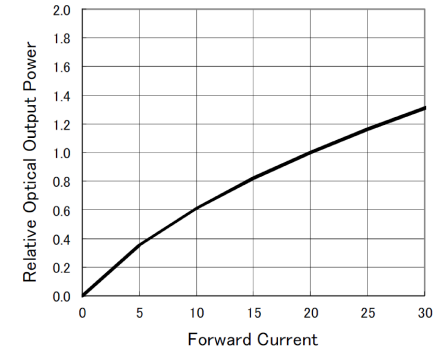

FORWARD VOLTAGE vs. FORWARD CURRENT
CONDITION : Ta=25°C

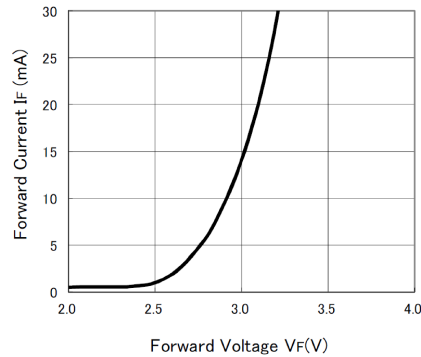

RELATIVE INTENSITY vs. WAVELENGTH
CONDITION : Ta=25°C, IF=20mA

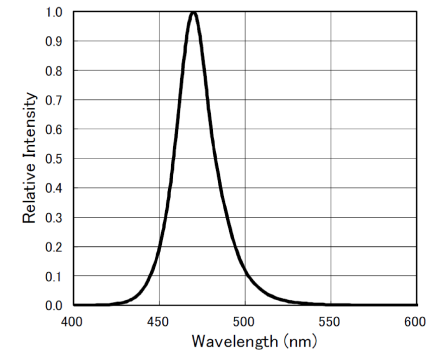

*UNLESS OTHERWISE SPECIFIED TOLERANCES PER DECIMAL PRECISION ARE: X=±1 (±0.039), X.X=±0.5 (±0.020), X.XX=±0.25 (±0.010), X.XXX=±0.127 (±0.005). LEAD SIZE=±0.05 (±0.002), LEAD LENGTH=±0.75 (±0.030), MIN= ^{±0.00} DECIMAL PRECISION, MAX= ^{±0.00} DECIMAL PRECISION



425 N. GARY AVE.
CAROL STREAM, IL 60188
PHONE : 800-278-5666
FAX : 630-315-2150
WEB : WWW.LUMEX.COM

6.8(L)*5.8(W)*2.9(H)mm, NARROW BEAM 6mm SMT LED, 470nm BLUE LED, WATER CLEAR LENS, TAPE & REEL.

THE SPECIFICATIONS MAY CHANGE AT ANY TIME WITHOUT NOTICE DUE TO NEW MATERIALS OR PRODUCT IMPROVEMENT.

CONFIDENTIAL INFORMATION
THE INFORMATION CONTAINED IN THIS DOCUMENT IS THE PROPERTY OF LUMEX INC. EXCEPT AS SPECIFICALLY AUTHORIZED IN WRITING BY LUMEX INC., THE HOLDER OF THIS DOCUMENT SHALL KEEP ALL INFORMATION CONTAINED HEREIN CONFIDENTIAL AND SHALL PROTECT SAME IN WHOLE OR IN PART FROM DISCLOSURE AND DISSEMINATION TO ALL THIRD PARTIES.

DATE : 2017.09.25	DRAWN BY : C.C.
PAGE : 3 OF 3	CHKD BY : G.Y.
SCALE : NTF	APRVD BY : E.C.
UNIT : mm [INCH]	Ⓢ