



Features

- Semi-shielded construction
- Miniature size
- Low profile - 1.8 mm max.
- Inductance range: 0.82 to 220 μ H
- High rated current - up to 4.0 A
- RoHS compliant* and halogen free**

Applications

- DC/DC converters
- Notebook computers
- Digital video cameras
- HDDs
- Cell phones
- Televisions, LCD displays

SRN4018 Series - Semi-shielded Power Inductors

Electrical Specifications @ 25 °C

Bourns Part No.	Inductance @ 100 KHz/1 V		DCR (Ω) Max.	I _{rms} (A)	I _{sat} (A)
	L (μ H)	Tol. %			
SRN4018-R82Y	0.82	30	0.019	4.0	4.7
SRN4018-1R0Y	1.0	30	0.023	3.7	4.2
SRN4018-1R2Y	1.2	30	0.025	3.5	4.0
SRN4018-1R5Y	1.5	30	0.032	3.1	3.5
SRN4018-2R2M	2.2	20	0.044	2.9	3.0
SRN4018-2R7M	2.7	20	0.052	2.3	2.4
SRN4018-3R3M	3.3	20	0.066	2.2	2.3
SRN4018-4R7M	4.7	20	0.084	1.9	2.0
SRN4018-6R8M	6.8	20	0.118	1.5	1.6
SRN4018-100M	10	20	0.180	1.3	1.4
SRN4018-150M	15	20	0.264	1.0	1.1
SRN4018-220M	22	20	0.348	0.9	0.95
SRN4018-330M	33	20	0.552	0.7	0.75
SRN4018-470M	47	20	0.780	0.6	0.62
SRN4018-680M	68	20	1.128	0.5	0.50
SRN4018-101M	100	20	1.596	0.42	0.45
SRN4018-151M	150	20	2.400	0.32	0.35
SRN4018-221M	220	20	3.552	0.28	0.30

General Specifications

Operating Temperature -25 °C to +120 °C
 (Temperature rise included)
 Storage Temperature .. -25 °C to +120 °C
 Resistance to Solder Heat +260 °C for 10 sec.
 Temperature Rise 40 °C at rated I_{rms}
 Rated Current Inductance drops 30 % at I_{sat}

Materials

Core Ferrite
 Wire Enameled copper
 Terminal Finish Sn
 Coating Magnetic epoxy resin
 Packaging 3000 pcs. per 13-inch reel

How to Order

SRN4018 - 100M

Model _____
 Value Code (see table) _____

Product Dimensions

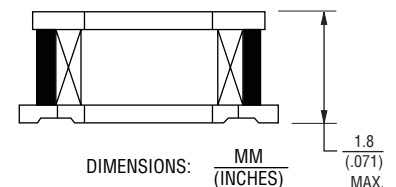
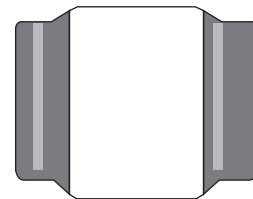
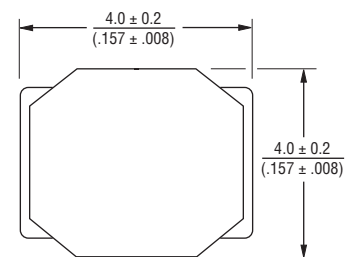

Soldering Profile

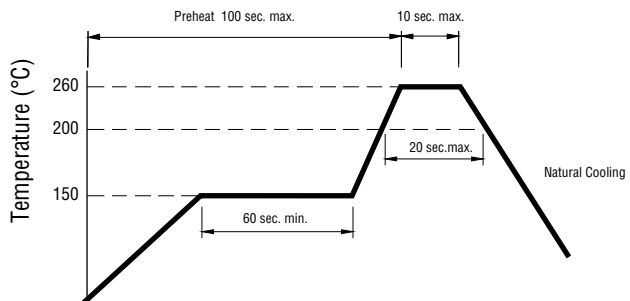

Electrical Schematic

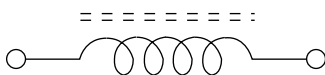

Recommended Layout

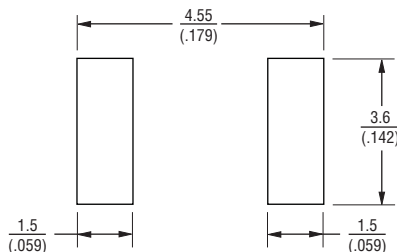

* RoHS Directive 2002/95/EC Jan. 27, 2003 including annex and RoHS Recast 2011/65/EU June 8, 2011.

** Bourns follows the prevailing definition of "halogen free" in the industry. Bourns considers a product to be "halogen free" if (a) the Bromine (Br) content is 900 ppm or less; (b) the Chlorine (Cl) content is 900 ppm or less; and (c) the total Bromine (Br) and Chlorine (Cl) content is 1500 ppm or less.

Specifications are subject to change without notice.
 Customers should verify actual device performance in their specific applications.

SRN4018 Series - Semi-shielded Power Inductors

BOURNS®

Packaging Specifications

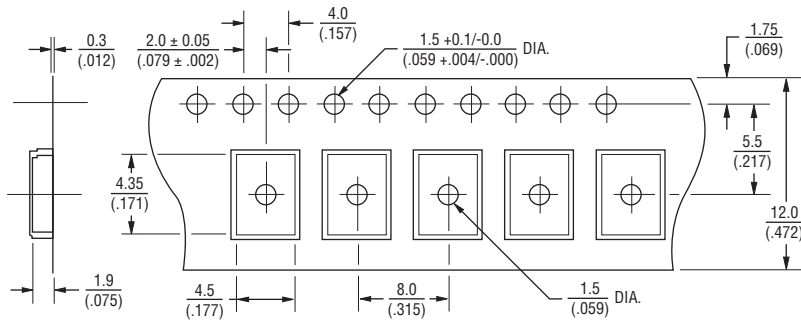
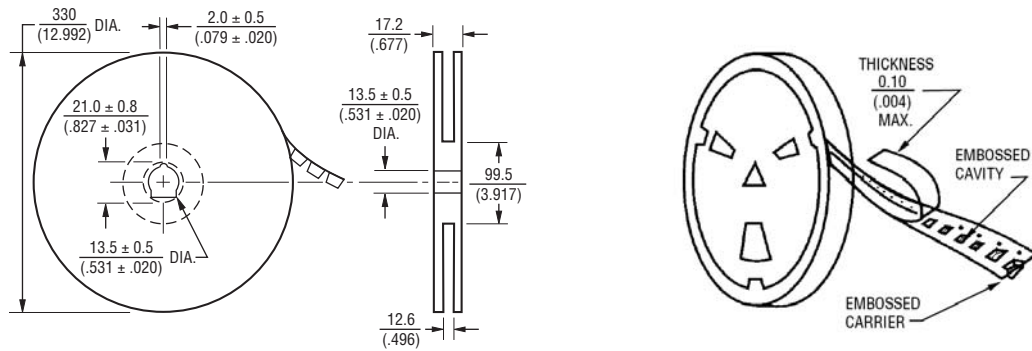

USER DIRECTION OF FEED →

QTY: 3000 PCS. PER REEL

DIMENSIONS: $\frac{\text{MM}}{\text{(INCHES)}}$

BOURNS®

Asia-Pacific: Tel: +886-2 2562-4117 • Fax: +886-2 2562-4116

Europe: Tel: +41-41 768 5555 • Fax: +41-41 768 5510

The Americas: Tel: +1-951 781-5500 • Fax: +1-951 781-5700

www.bourns.com