

230-400 V Input	13.6 V Output	45 A Current	589.5 W Power	4250 V Isolation	EXTENDED Eighth-brick DC-DC Converter
---------------------------	-------------------------	------------------------	-------------------------	----------------------------	---

The BQ4H136EEC45 bus converter is a next-generation, board-mountable, isolated, fixed switching frequency DC-DC converter that uses synchronous rectification to achieve extremely high conversion efficiency. The BusQor® series provides an isolated step down voltage from 385 V to 13.6 V intermediate bus with no regulation in a extended standard eighth brick module. The BQ4H136EEC45 converter is ideal for creating the mid-bus voltage required to drive standard DC-DC non-isolated converters.

BusQor®



Operational Features

- High efficiency, 96.2% at full rated load current
- Delivers 45 A full power with minimal derating
- Operating input voltage range: 230-400 V
- Fixed frequency switching provides predictable EMI
- No minimum load requirement

Control Features

- On/Off control referenced to input side
- Inherent current share (by droop method) for high current and parallel applications.

Safety Features

- UL 60950-1:2007/R:2011-12
- EN 60950-1:2006/A2:2013
- CAN/CSA C22.2 No. 60950-1:2007/A1:2011

Mechanical Features

- Industry standard eighth-brick pin-out configuration
- Encased size: 1.00" x 2.70" x 0.50" (25.4 x 68.6 x 12.7 mm)
- Total Encased weight: 2.24 oz (63.4 g)

Protection Features

- Input under-voltage and over-voltage lockout protects
- Output current limit and short circuit protection (auto recovery)
- Thermal shutdown

Contents

	Page No.
Encased Mechanical Diagram	2
Electrical Characteristics	3
Compliance & Testing	5
Technical Figures	6
Applications Section	9
Ordering Information	13

Input: 230-400 V
Output: 13.6 V
Current: 45 A
Package: EXTENDED Eighth-brick

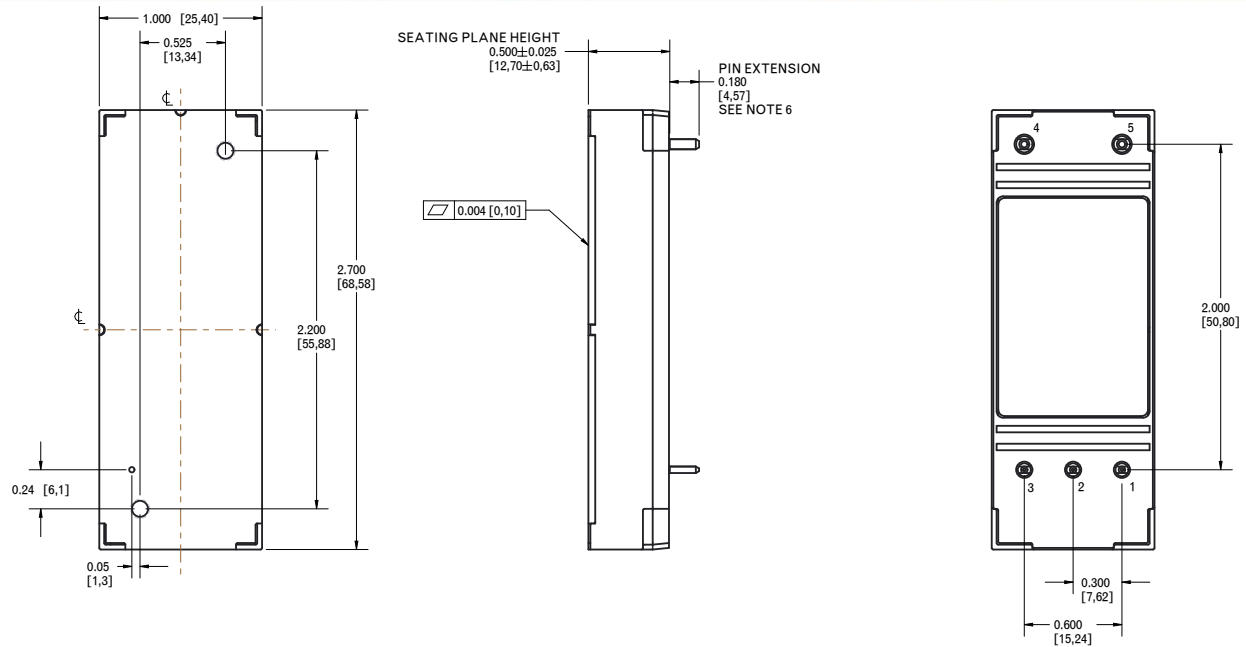

NOTES

- 1) APPLIED TORQUE PER M3 SCREW IS NOT TO EXCEED 6 in-lb. SCREW SHOULD NOT EXCEED 0.100" (2.54 mm) DEPTH BELOW THE SURFACE OF THE BASEPLATE.
- 2) BASEPLATE FLATNESS TOLERANCE IS 0.004" (.10 mm) TIR FOR SURFACE.
- 3) PINS 1-3 ARE 0.040" (1.02 mm) DIA. WITH 0.080" (2.03 mm) DIA. STANDOFFS.
- 4) PINS 4 AND 5 ARE 0.062" (1.57 mm) DIA. WITH 0.100" (2.54 mm) DIA STANDOFFS.
- 5) ALL PINS: MATERIAL: COPPER ALLOY
FINISH: MATTE TIN OVER NICKEL PLATE
- 6) ALTERNATIVE PIN LENGTH MAY BE AVAILABLE.
CHECK WITH FACTORY.
- 7) WEIGHT: 2.24 oz (63.4 g)
- 8) ALL DIMENSIONS IN INCHES(mm)
- 9) TOLERANCES: x.xx in +/-0.02 (x.x mm +/-0.5 mm)
x.xxx in +/-0.010 (x.xx mm +/-0.25 mm)

PIN DESIGNATIONS

Pin	Name	Function
1	+VIN	Positive input voltage
2	ON/OFF	Logic control input to turn converter on/off.
3	-VIN	Negative input voltage
4	-VOUT	Negative output voltage
5	+VOUT	Positive output voltage

BQ4H136EEC45 Electrical Characteristics

Ta = 25 °C, airflow rate = 300 LFM, Vin = 385 Vdc unless otherwise noted; full operating temperature range is -40 °C to +100 °C baseplate temperature with appropriate power derating. Specifications subject to change without notice.

Parameter	Min.	Typ.	Max.	Units	Notes & Conditions
ABSOLUTE MAXIMUM RATINGS					
Input Voltage					
Non-Operating	-0.5		500	V	Continuous
Operating			450	V	Transient, 100 ms
Isolation Voltage					Reinforced
Input to Output			4250	Vdc	
Input to Baseplate			2300	Vdc	
Output to Baseplate			2300	Vdc	
Operating Temperature	-40		100	°C	Baseplate temperature
Storage Temperature	-45		125	°C	
Voltage at ON/OFF input pin	-2		18	V	
INPUT CHARACTERISTICS					
Operating Input Voltage Range	230	385	400	V	Continuous
	230	385	450	V	Transient, 100 ms; dv/dt < 0.5 V/μs
Input Under-Voltage Lockout					
Turn-On Voltage Threshold		215		V	
Turn-Off Voltage Threshold		200		V	
Lockout Voltage Hysteresis		15		V	
Input Over-Voltage Shutdown				V	
Turn-On Voltage Threshold		410		V	
Turn-Off Voltage Threshold		420		V	
Maximum Input Current			3.2	A	Vin = 230 V
No-Load Input Current		24		mA	
Disabled Input Current		5		mA	
Input Reflected-Ripple Current		10	20	mA	RMS through 10 μH inductor
Input Terminal-Ripple Current		45		mA	RMS, full load
Recommended Input Fuse (see Note 1)			10	A	Fast blow external fuse recommended
Recommended External Input Capacitance		10		μF	Typical ESR 0.1-0.2 Ω
Input Filter Component Values (L/C)		4.7\0.33		μH\μF	Internal values
OUTPUT CHARACTERISTICS					
Output Voltage Set Point		13.8		V	Vin = 385 V, Io = 0 A
Output Voltage Regulation					
Over Line		47/6.10		%\V	
Over Load		3.1/400		%\mV	
Over Temperature		2.4/300		%\mV	
Total Output Voltage Range	7.40		14.30	V	Over sample, line, load, temperature & life
Output Voltage Ripple and Noise					20 MHz bandwidth; see Note 2
Peak-to-Peak		120	240	mV	Full load
RMS		60	125	mV	Full load
Operating Output Current Range	0		45	A	Subject to thermal derating; Vin = 385 V
Output DC Current-Limit Inception		52		A	Vin = 385 V
Output DC Current-Limit Shutdown Voltage		11.5		V	Vin = 385 V
Back-Drive Current Limit while Disabled		50		mA	Negative current drawn from output
Maximum Output Capacitance			2,000	μF	Vin = 385 V and 23 A Resistive Load
EFFICIENCY					
100% Load		96.2		%	
50% Load		95.6		%	

BQ4H136EEC45 Electrical Characteristics (continued)

Ta = 25 °C, airflow rate = 300 LFM, Vin = 385 Vdc unless otherwise noted; full operating temperature range is -40 °C to +100 °C baseplate temperature with appropriate power derating. Specifications subject to change without notice.

Parameter	Min.	Typ.	Max.	Units	Notes & Conditions
DYNAMIC CHARACTERISTICS					
Output Voltage during Load Current Transient					
Step Change in Output Current (0.1 A/μs)		200		mV	50% to 75% to 50% Iout max
Settling Time		50		μs	To within 1% Vout nom
Turn-On Transient					
Turn-On Time		20	30	ms	Half load (resistive), Vout=90% nom.
Start-Up Inhibit Time		800		ms	Figure E
Output Voltage Overshoot		0		%	2 mF load capacitance, Io = 0 A
ISOLATION CHARACTERISTICS					
Isolation Voltage (dielectric strength)			4250	V	See Absolute Maximum Ratings
Isolation Resistance		100		MΩ	
Isolation Capacitance (input to output)		N/A		pF	Note 3
Semiconductor Junction Temperature			125	°C	Package rated to 150 °C
Board Temperature			125	°C	UL rated max operating temp 130 °C
Transformer Core Temperature			125	°C	
Maximum Baseplate Temperature, Tb			100	°C	
FEATURE CHARACTERISTICS					
Switching Frequency	330	350	370	kHz	
ON/OFF Control					
On-State Voltage	-1		0.4	V	
Off-State Voltage	2		18	V	
ON/OFF Control					Application notes Figures A & B
Pull-Up Voltage		5		V	
Pull-Up Resistance		124		kΩ	
Over-Temperature Shutdown OTP Trip Point	140		150	°C	Average PCB Temperature
Over-Temperature Shutdown Restart Hysteresis		10		°C	
RELIABILITY CHARACTERISTICS					
Calculated MTBF (Telcordia) TR-NWT-000332		3.2		10 ⁶ Hrs.	Tb = 70 °C
Calculated MTBF (MIL-217) MIL-HDBK-217F		2.7		10 ⁶ Hrs.	Tb = 70 °C
Field Demonstrated MTBF				10 ⁶ Hrs.	See our website for details

Note 1: Product certification tests were carried out using 10 A fast blow fuse. Fuse interruption characteristics have to be taken into account while designing input traces. User should ensure that Input trace is capable of withstanding fault currents

Note 2: For applications requiring reduced output voltage ripple and noise, consult SynQor applications support (e-mail: support@synqor.com)

Note 3: Isolation capacitance can be added external to the module (recommended).



Technical Specification

Input: 230-400 V
Output: 13.6 V
Current: 45 A
Package: EXTENDED Eighth-brick

Compliance & Testing

Parameter	Notes & Conditions
-----------	--------------------

STANDARDS COMPLIANCE

UL 60950-1:2007/R:2011-12	Basic insulation
EN 60950-1:2006/A2:2013	
CAN/CSA C22.2 No. 60950-1:2007/A1:2011	

Note: An external input fuse must always be used to meet these safety requirements. Contact SynQor for official safety certificates on new releases or download from the SynQor website.

Parameter	# Units	Test Conditions
-----------	---------	-----------------

QUALIFICATION TESTING

Life Test	32	95% rated Vin and load, units at derating point, 1000 hours
Vibration	5	10-55 Hz sweep, 0.060" total excursion, 1 min./sweep, 120 sweeps for 3 axis
Mechanical Shock	5	100 g minimum, 2 drops in x, y and z axis
Temperature Cycling	10	-40 °C to 100 °C, unit temp. ramp 15 °C/min., 500 cycles
Power/Thermal Cycling	5	Toperating = min to max, Vin = min to max, full load, 100 cycles
Design Marginality	5	Tmin-10 °C to Tmax+10 °C, 5 °C steps, Vin = min to max, 0-105% load
Humidity	5	85 °C, 95% RH, 1000 hours, continuous Vin applied except 5 min/day
Solderability	15 pins	MIL-STD-883, method 2003

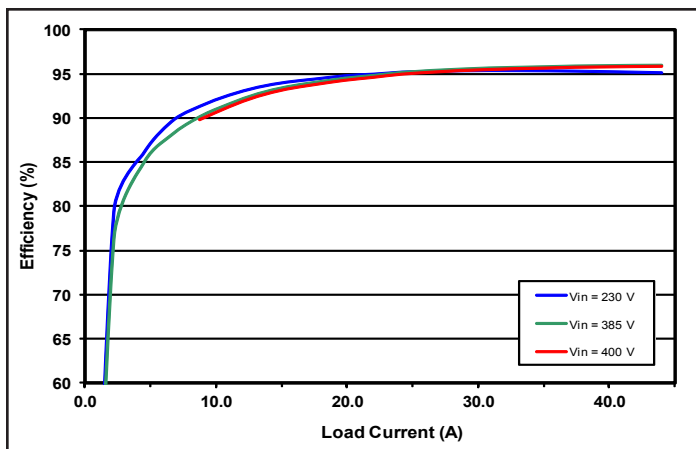

Figure 1: Efficiency at nominal output voltage vs. load current for minimum, nominal, and maximum input voltage at 25 °C.

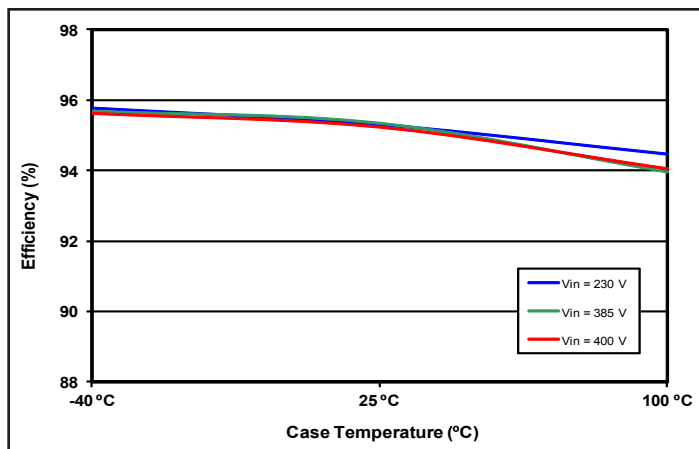

Figure 2: Efficiency vs. case temperature for minimum, nominal, and maximum input voltage and 60% rated power.

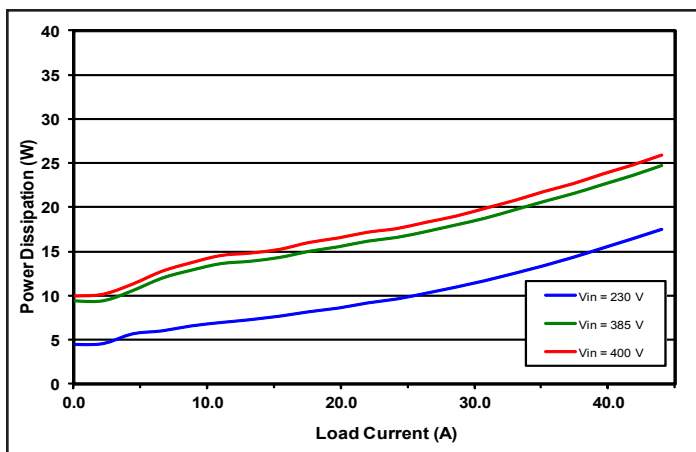

Figure 3: Power dissipation vs. load current for minimum, nominal, and maximum input voltage at T_{CASE}=25 °C.

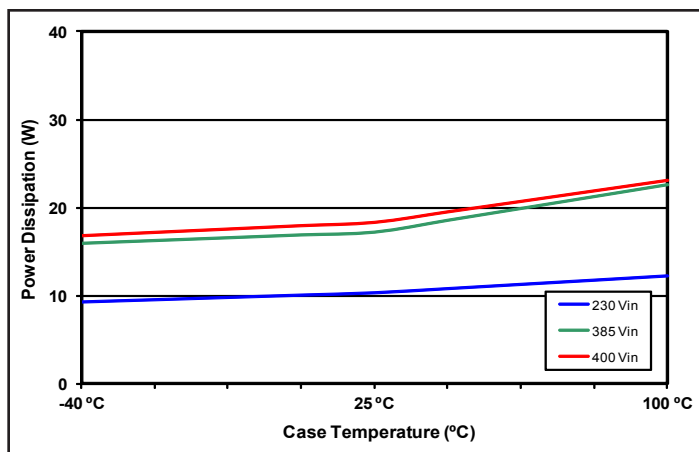

Figure 4: Power dissipation vs. case temperature for minimum, nominal, and maximum input voltage and 60% rated power.

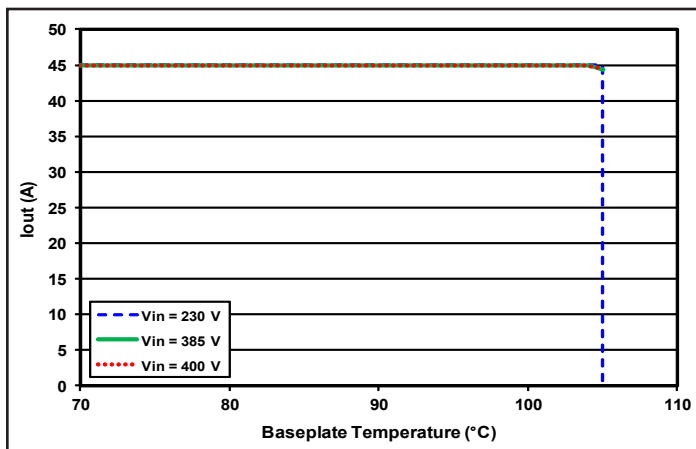

Figure 5: Maximum output current vs. baseplate temperature.

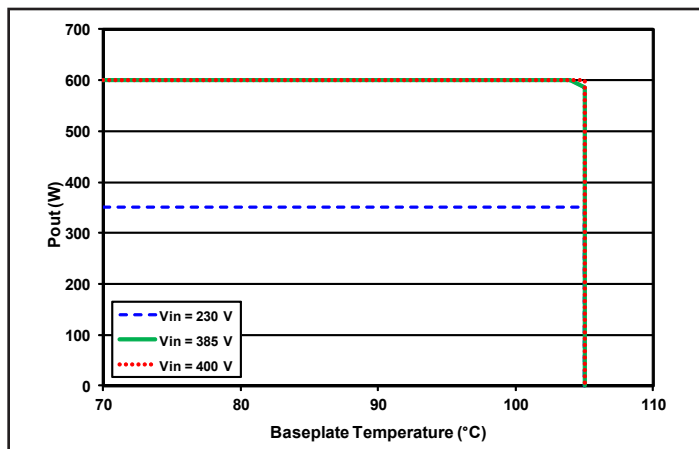

Figure 6: Maximum output power vs. baseplate temperature.

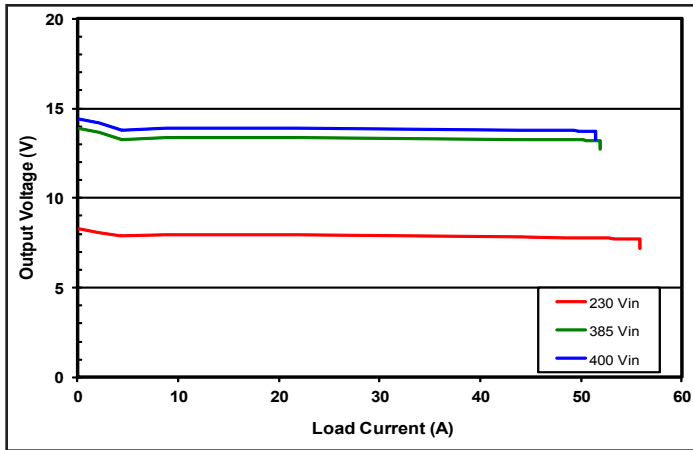

Figure 7: Output voltage vs. load current for different input voltages showing typical current limit curves.

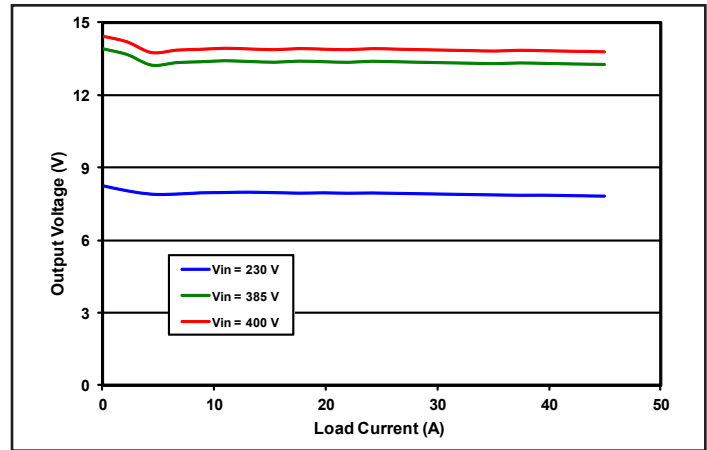

Figure 8: Output voltage vs. load current, regulation curves for minimum, nominal, and maximum input voltage at TCASE=25 °C.

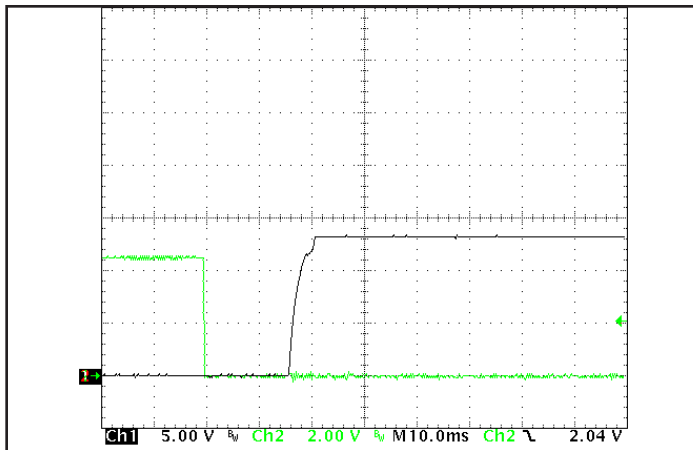

Figure 9: Turn-on transient at half load (resistive load) (10 ms/div). Load cap: 15 µF tantalum capacitor. Input voltage pre-applied. Ch 1: Vout (5 V/div). Ch 2: ON/OFF input (2 V/div).

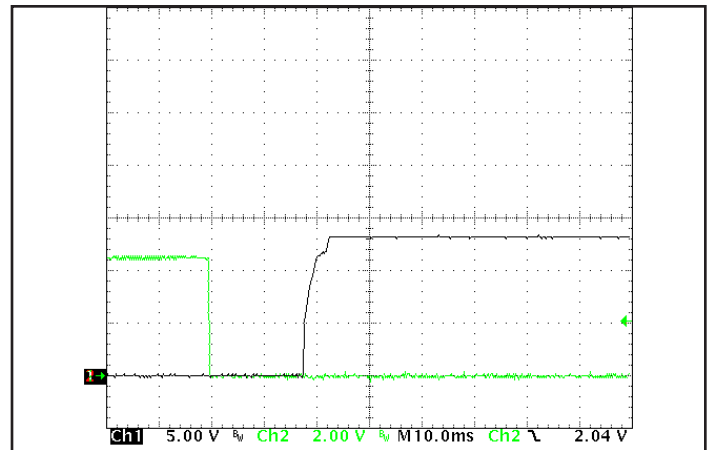

Figure 10: Turn-on transient at half load (resistive load) (10 ms/div). Load cap: 15 µF tantalum capacitor and 2 mF ceramic capacitor bank. Input voltage pre-applied. Ch 1: Vout (5 V/div). Ch 2: ON/OFF input (2 V/div).

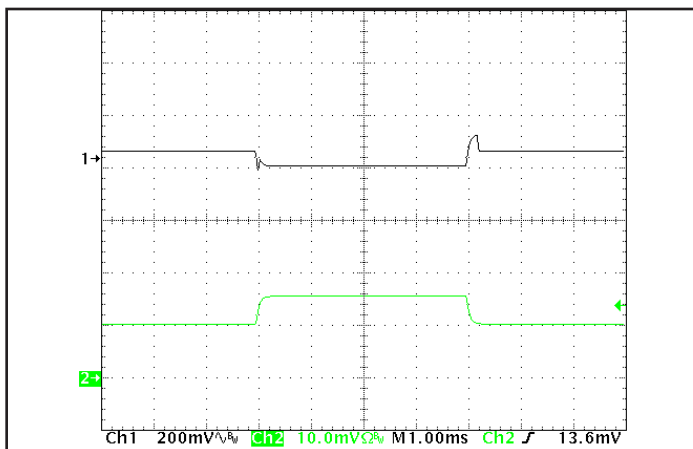

Figure 11: Output voltage response to step-change in load current (50%-75%-50% of Iout(max); dI/dt = 0.1 A/µs). Load cap: 15 µF tantalum cap and 1 µF ceramic cap. Ch 1: Vout (500 mV/div), Ch 2: Iout (50 A/div).

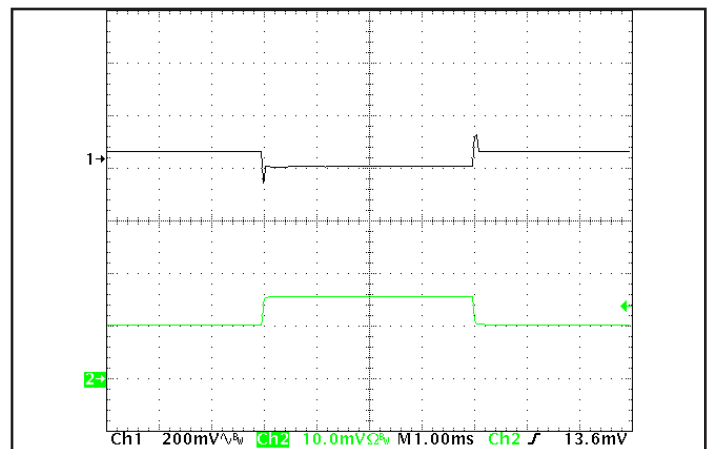

Figure 12: Output voltage response to step-change in load current (50%-75%-50% of Iout(max); dI/dt = 1 A/µs). Load cap: 15 µF, 30 mΩ ESR tantalum cap and 1 µF ceramic cap. Ch 1: Vout (500 mV/div), Ch 2: Iout (50 A/div).

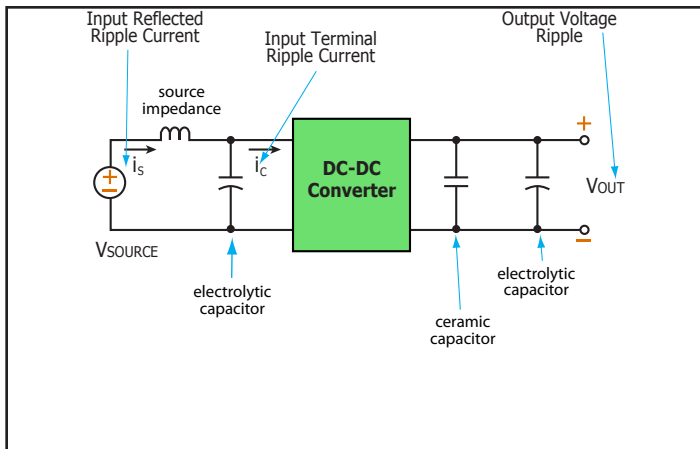

Figure 13: Test set-up diagram showing measurement points for Input Terminal Ripple Current (Figure 14), Input Reflected Current (Figure 15) and Output Voltage Ripple (Figure 16).

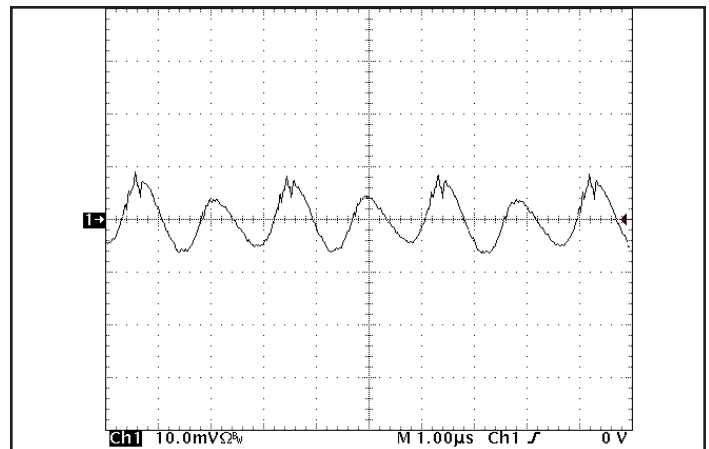

Figure 14: Input terminal ripple current, i_c , at full rated output current and nominal input voltage with 10 μ H source impedance and 47 μ F ceramic capacitor (50 mA/div). See Figure 13.

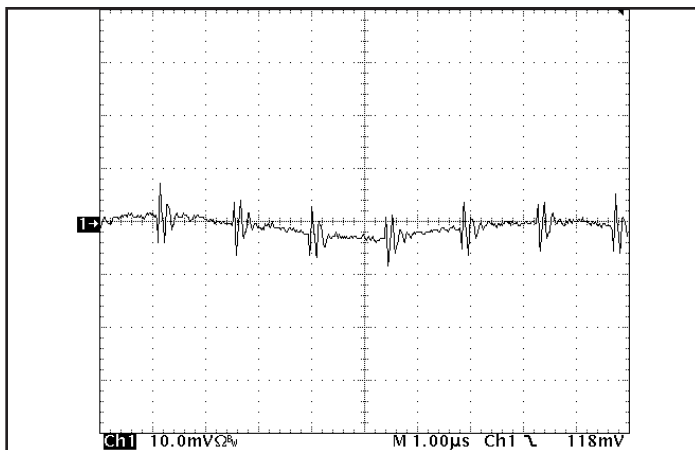

Figure 15: Input reflected ripple current, i_s , through a 10 μ H source inductor, using a 47 μ F ceramic input capacitor (10 mA/div). See Figure 13.

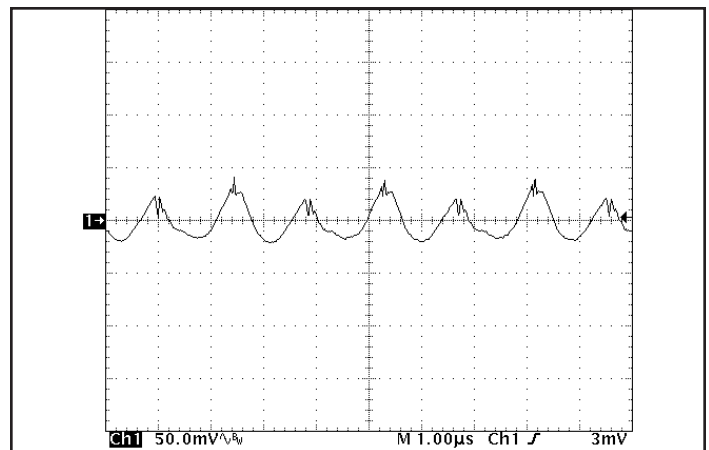

Figure 16: Output voltage ripple at nominal input voltage and rated load current (50 mV/div). Load capacitance: 1 μ F ceramic capacitor and 15 μ F tantalum capacitor. Bandwidth: 20 MHz. See Figure 13.

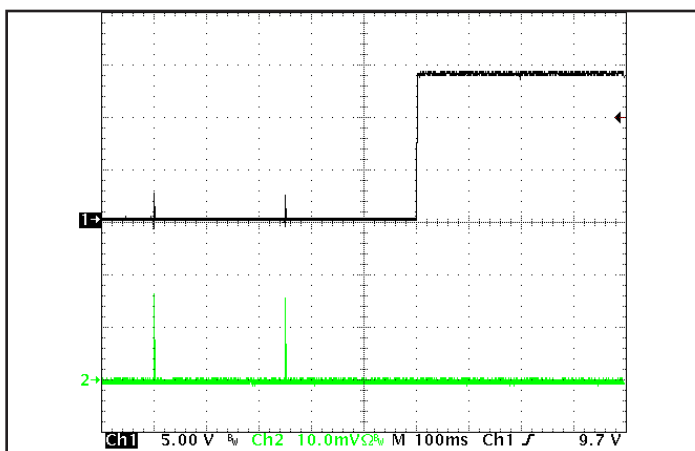

Figure 17: Rise of output voltage after the removal of a short circuit across the output terminals. $R_{short} = 5 \text{ m}\Omega$. Ch1: V_{out} (5 V/div). Ch 2: I_{out} (50 A/div). Bandwidth: 20 MHz.

BASIC OPERATION AND FEATURES

With voltages dropping and currents rising, the economics of an Intermediate Bus Architecture (IBA) are becoming more attractive, especially in systems requiring multiple low voltages. IBA systems separate the role of isolation and voltage scaling from regulation and sensing. The BusQor series bus converter provides isolation and an unregulated voltage step down in one compact module, leaving regulation to simpler, less expensive non-isolated converters.

In Figure A below, the BusQor module provides the isolation stage of the IBA system. The isolated bus then distributes power to the non-isolated buck regulators to generate the required voltage levels at the points of load. In this case, the bucks are represented with SynQor's NiQor series of non-isolated DC-DC converters. In many applications requiring multiple low voltage outputs, significant savings can be achieved in board space and overall system costs.

When designing an IBA system with bus converters, the designer can select from a variety of bus voltages. While there is no universally ideal bus voltage, most designs employ one of the following: 31 V, 28 V, 24 V, 12 V, 9.6 V, or 6 V. Higher bus voltages can lead to lower efficiency for the buck regulators but are more efficient for the bus converter and provide lower board level distribution current. Lower bus voltages offer the opposite trade offs.

SynQor's BusQor modules act as a true dc transformer. The output voltage is proportional to the input voltage, with a specified "turns ratio" or voltage ratio, plus minor drop from the internal resistive losses in the module. When used in IBA systems, the output variation of the BusQor must be in accordance with the input voltage range of the non-isolated converters being employed.

The BusQor architecture is very scalable, meaning multiple bus converters can be connected directly in parallel to allow current sharing for higher power applications.

CONTROL FEATURES

REMOTE ON/OFF (Pin 2): The ON/OFF input, Pin 2, permits the user to control when the converter is on or off. This input is referenced to the return terminal of the input bus, Vin(-).

In the negative logic version, the ON/OFF signal is active low (meaning that a low turns the converter on). Figure B is a detailed look of the internal ON/OFF circuitry.

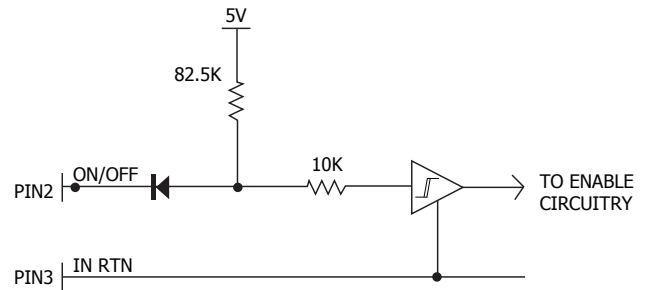

Figure B: Internal ON/OFF pin circuitry

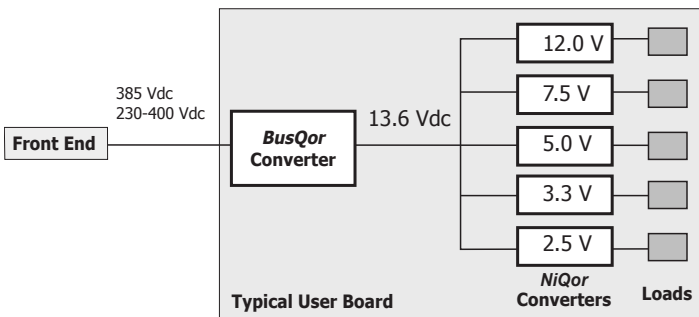

Figure A: Example of Intermediate Bus Architecture using isolated or non-isolated converters.

PROTECTION FEATURES

Input Under-Voltage Lockout: The converter is designed to turn off when the input voltage is too low, helping avoid an input system instability problem, described in more detail in the application note titled "Input System Instability". The lockout circuitry is a comparator with DC hysteresis. When the input voltage is rising, it must exceed the typical Turn-On Voltage Threshold value (listed on the specification page) before the converter will turn on. Once the converter is on, the input voltage must fall below the typical Turn-Off Voltage Threshold value before the converter will turn off. Also see Figure E.

Input Over-Voltage Shutdown: The converter also has a two stage over-voltage feature that limits the converter's duty cycle for 100 ms before shutdown and a higher second level with no delay before shutdown if the input voltage is too high (See the Input Over-Voltage Shutdown section in the Electrical Characteristics Table for specific voltage levels). It also has a hysteresis and time delay to ensure proper operation.

Output Current Limit: The output of the BusQor module is electronically protected against output overloads. When an overload current greater than the "DC Current-Limit Inception" specification is drawn from the output, the output shuts down to zero volt in a period of 1 ms typical (see Figure C). The shutdown period lasts for a typical period of 250 ms (Figure D) after which the BusQor tries to power up again (10 ms). If the overload persists, the output voltage will go through repeated cycles of shutdown and restart with a duty cycle of 4% (On) and 96% (Off) respectively.

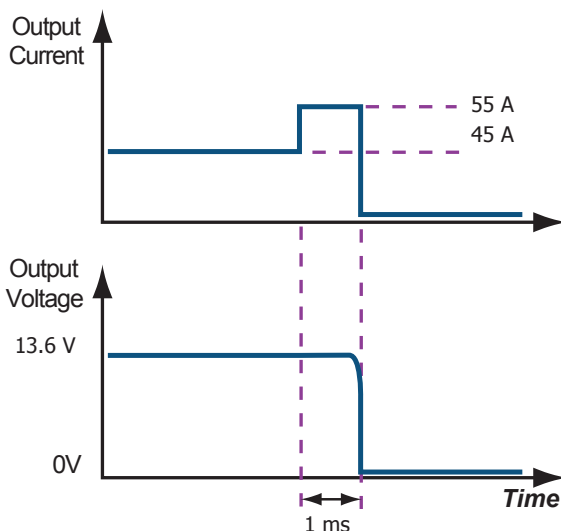

Figure C: Output Overload protection diagram (not to scale)

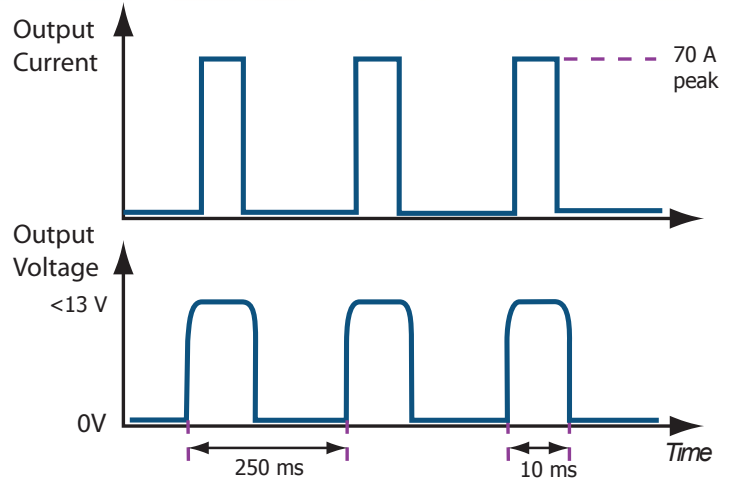

Figure D: Output Short Circuit and Auto-Resetting protection diagram (not to scale)

The BusQor module returns (auto resetting) to normal operation once the overload is removed. The BusQor is designed to survive in this mode indefinitely without damage and without human intervention.

Output Short Circuit Protection: When the output of the BusQor module is shorted, a peak current of typically 70 A will flow into the short circuit for a period not greater than 1 ms (typically 200 μ s). The output of the BusQor will shutdown to zero for \sim 250 ms (Figure D). At the end of the shutdown period the BusQor module tries to power up again. If the short circuit persists, the output voltage will go through repeated cycles of shutdown and restart with a duty cycle of 4% (On) and 96% (Off) respectively. The BusQor module returns (auto resetting) to normal operation once the short circuit is removed. The BusQor is designed to survive in this mode indefinitely without damage and without human intervention.

In the Auto resetting mode, also referred to as "Hiccup" mode, the power drawn from the 385 V input is about \sim 10 Watts, most of which is dissipated into the external fault. It is important that copper traces and pads from the output circuit be designed to withstand the short term peaks, although the average current into the fault may be as low as 0.04 A typical. See Figure 17 for appropriate waveform.

Over-Temperature Shutdown: A temperature sensor on the converter senses the average temperature of the module. The thermal shutdown circuit is designed to turn the converter off when the temperature at the sensed location reaches the Over-Temperature Shutdown value. It will allow the converter to turn on again when the temperature of the sensed location falls by the amount of the Over-Temperature Shutdown Restart Hysteresis value.

APPLICATION CONSIDERATIONS

Start-Up Inhibit Period: Figure E details the Start-Up Inhibit Period for the BusQor module. At time t_0 , when V_{in} is applied with On/Off pin asserted (enabled), the BusQor output begins to build up. Before time t_1 , when the input voltage is below the UVL threshold, the unit is disabled by the Input Under-Voltage Lockout feature. When the input voltage rises above the UVL threshold, the Input Under-Voltage Lockout is released, and a typical Initial Startup Inhibit Period of 70 ms is initiated. The output builds up to 90% of the nominal value of 13.6 V in a period of 20 ms typical (50% load).

At time t_2 , when the On/Off pin is de-asserted (disabled), the BusQor output instantly drops to 0 V. Fall time from 13.6 V to 0 V is dependent on output capacitance and any parasitic trace inductance in the output load circuit.

At time t_3 , when the On/Off pin is re-asserted (enabled), the BusQor module output begins to build up after the inhibit period of 250 ms typical has elapsed.

Refer to the Control Features section of the data sheet for details on enabling and disabling methods for Bus Qor modules.

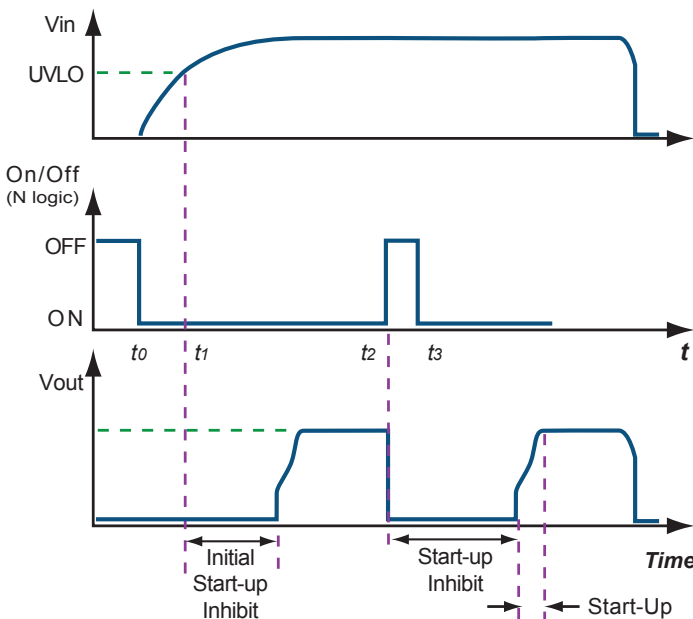

Figure E: Power Up/Down Diagram (not to scale) showing Start-Up Inhibit Period

Thermal Derating Test Setup

The curves showing the derating of output current and power as a function of the baseplate temperature are taken with the oven setup shown in Figure F. The converter module is soldered to a carrier PCB that is mounted horizontally within an oven. The carrier PCB is a four layer 4 oz PCB. A large aluminum heatsink (thermal grease is applied between the baseplate and the heatsink interface to minimize the thermal impedance) is attached to the baseplate to keep the baseplate temperature constant during thermal testing. A small hole is drilled through the heatsink in order to attach a thermocouple to the baseplate of the DTU. Additional thermocouples are attached to the hottest components before baseplating to monitor the internal temperature of all of the critical components during testing. The oven temperature is controlled so as to keep the baseplate temperature to the desired value. The baseplate temperature is kept at 100 °C or below for all conditions. If the temperature of an internal component exceeds 125 °C, the output current (power level) is reduced so as to keep the temperature of all internal components below 125 °C.

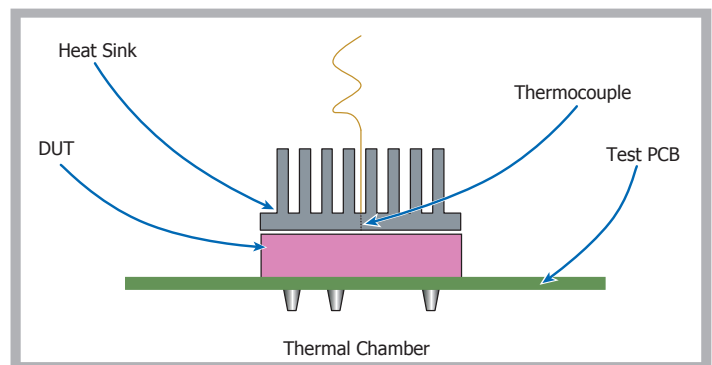

Figure F: Thermal chamber setup for derating curves.

Current Sharing: BQ4H BusQor modules are designed to operate in parallel without the use of any external current share circuitry. Current sharing is achieved through "Droop Share". An output capacitor is recommended across each module and located close to the converter for optimum filtering and noise control performance. Dedicated input inductors are recommended but are considered optional. Input capacitors must be located close to the converter module. PCB layout in the input circuit should be such that high frequency ripple currents of each module is restricted to a loop formed by the input capacitors and the input terminals of the BusQor module. See Figure G for details on PCB layout. Contact SynQor application engineering for further assistance on PCB trace design.

The current share performance of two paralleled modules is illustrated in the graph in Figure H. In this graph the percent deviation from ideal sharing (50%) is plotted for each module versus the total output load current at 385 Vin. Two BQ4H BusQor's will share within 10% at higher loads. The current share accuracy is affected by changes in the gate drive timing. The gate drive timing is adjusted as a function of load to better optimize the product efficiency over line and load (performance), resulting in higher load share deviations at lighter loads.

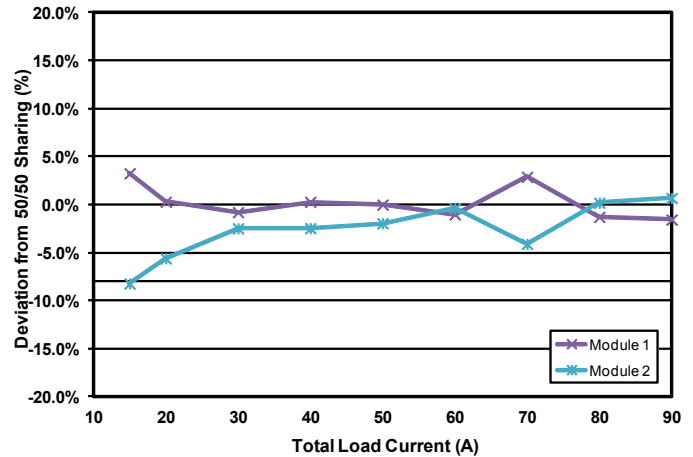

Figure H: Typical current share performance of 2 paralleled modules

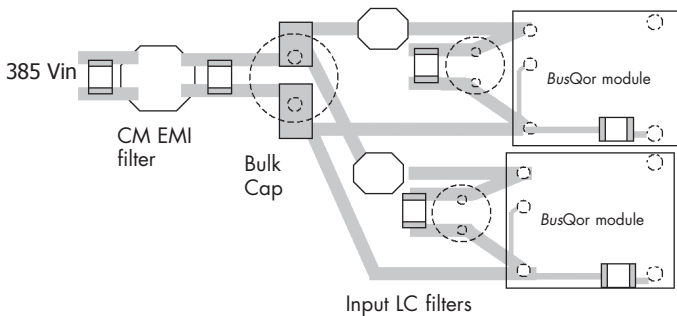

Figure G: Recommended physical implementation of two BusQor's in parallel.



Ordering Information

Input: 230-400 V
Output: 13.6 V
Current: 45 A
Package: EXTENDED Eighth-brick

Part Numbering System

The part numbering system for SynQor's dc-dc converters follows the format shown in the example below.

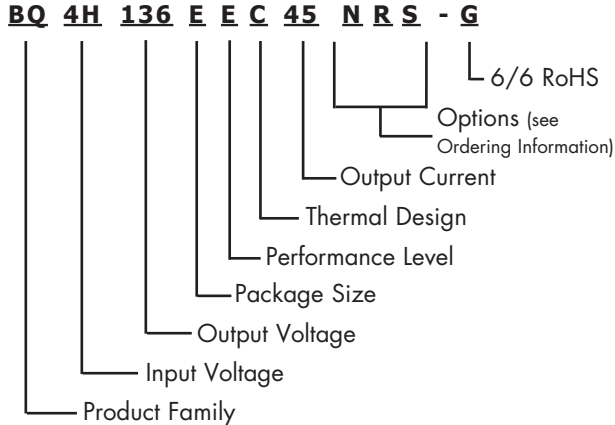

The first 12 characters comprise the base part number and the last 3 characters indicate available options. The "-G" suffix indicates 6/6 RoHS compliance.

Application Notes

A variety of application notes and technical white papers can be downloaded in pdf format from our [website](#).

RoHS Compliance: The EU led RoHS (Restriction of Hazardous Substances) Directive bans the use of Lead, Cadmium, Hexavalent Chromium, Mercury, Polybrominated Biphenyls (PBB), and Polybrominated Diphenyl Ether (PBDE) in Electrical and Electronic Equipment. This SynQor product is 6/6 RoHS compliant. For more information please refer to SynQor's RoHS addendum available at our [RoHS Compliance / Lead Free Initiative web page](#) or e-mail us at rohs@synqor.com.

Contact SynQor for further information and to order:

Phone: 978-849-0600
Toll Free: 888-567-9596
Fax: 978-849-0602
E-mail: power@synqor.com
Web: www.synqor.com
Address: 155 Swanson Road
 Boxborough, MA 01719
 USA

Ordering Information

The tables below show the valid model numbers and ordering options for converters in this product family. When ordering SynQor converters, please ensure that you use the complete 15 character part number consisting of the 12 character base part number and the additional characters for options. Add "-G" to the model number for 6/6 RoHS compliance.

Model Number	Input Voltage	Output Voltage	Max Output Current
BQ4H136EEC45xyz-G	230-400 V	13.6 V	45 A

The following options must be included in place of the **wxyz** spaces in the model numbers listed above.

Options Description: w x y z			
Thermal Design	Enable Logic	Pin Style	Feature Set
C - Encased	N - Negative	N - 0.145" R - 0.180" Y - 0.250"	S - Standard

Not all combinations make valid part numbers, please contact SynQor for availability.

PATENTS

SynQor holds numerous U.S. patents, one or more of which apply to most of its power conversion products. Any that apply to the product(s) listed in this document are identified by markings on the product(s) or on internal components of the product(s) in accordance with U.S. patent laws. SynQor's patents include the following:

5,999,417	6,222,742	6,545,890	6,594,159	6,894,468	6,896,526
6,927,987	7,050,309	7,072,190	7,085,146	7,119,524	7,269,034
7,272,021	7,272,023	7,558,083	7,564,702	7,765,687	7,787,261
8,023,290	8,149,597	8,493,751	8,644,027	9,143,042	

WARRANTY

SynQor offers a three (3) year limited warranty. Complete warranty information is listed on our website or is available upon request from SynQor.