

0.9 mm Pitch Vertical Mating Board-to-Wire Connectors

DF24 Series

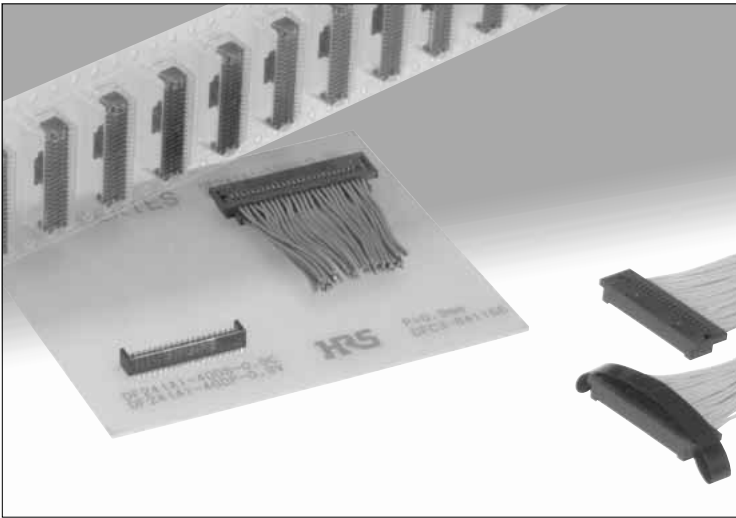

■ Features

1. Space saving

Small contact pitch (0.9 mm) together with vertical mating direction allows high density mounting of the board components.

2. Low profile

Two-level contact location and horizontal wire exits allow a low profile of 3.8 mm, when fully.

3. Reliable mating/un-mating

Complete vertical mating, with both sides self-aligned, is confirmed with tactile "click" sensation.

4. High contact reliability

2-point socket contact, with a long wipe (0.55 mm) assures highly reliable electrical and mechanical connection.

5. Prevention of solder wicking

Despite its low-profile, solder wicking is prevented by the nickel barrier and solder collection areas.

6. Self-alignment and side-pull protection

The walls of the double row socket assembly will self-align during the mating and protect header and socket assemblies from an accidental side-pull on the wires.

7. Simplified un-mating

A pull strap for double row socket version may be selected for easier un-mating.

8. Contact deformation protection

Flat contact blades on the headers are supported by the insulator's walls, protecting them from deformation during handling.

9. Board placement with automatic equipment

Supplied on reels containing 1,000 assemblies.

10. RoHS compliant

All components and materials comply with the requirements of the EU Directive 2002/95/EC.

■ Applications

Notebook computers, miniature office automation devices, miniature consumer devices, cameras, recording devices and other devices requiring vertical mating reliable connectors.

Space-saving

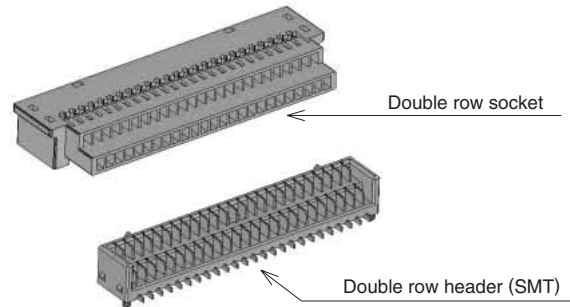

Low-profile

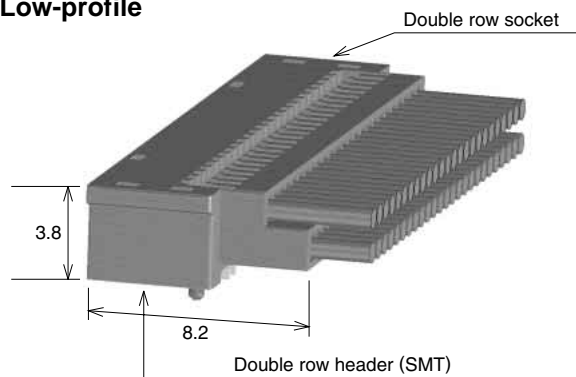

Long contact wipe

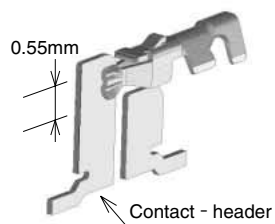

Two-point socket contact

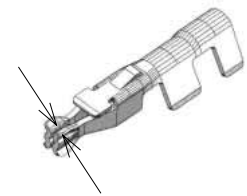

Self-alignment and side-pull protection

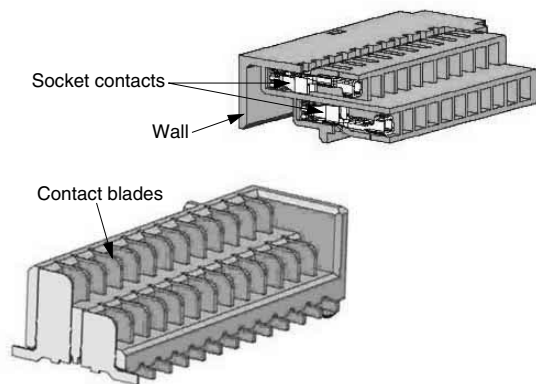

Contact deformation protection

DF24 Series 0.9 mm Pitch Vertical Mating Board-to-Wire Connectors

Product Specifications

Rating	Current rating (Note 1)	Wire size	AWG28 :1A AWG30 :0.5A AWG32~36 :0.3A	Operating temperature range Operating humidity range	-35°C to +85°C (Note 2) Relative humidity 20% to 80%
	Voltage rating		80V AC	Storage temperature range Storage humidity range	-10°C to +60°C (Note 3) Relative humidity 40% to 70% (Note 3)

Item	Specification	Conditions
1. Insulation resistance	500 M ohms min.	100V DC
2. Withstanding voltage	No flashover or insulation breakdown.	250V AC/one minute
3. Contact resistance	30 mΩ max.	1 mA, 20 mV max.
4. Insertion-Extraction force (per contact)	0.12N min., 2N max.	Measured with a steel pin of 0.15mm thickness
5. Vibration	No electrical discontinuity of 1μs or more.	Frequency: 10 to 55 Hz, single amplitude of 0.75mm, 2 hours, 3 axis
6. Humidity	Contact resistance: 30 mΩ max. Insulation resistance: 250 MΩ min.	96 hours at temperature of 40±2°C and humidity of 90% to 95%.
7. Temperature cycle	Contact resistance: 30 mΩ max. Insulation resistance: 500 MΩ min.	Temperature: -55°C → +5°C to +35°C → +85°C → +5°C to +35°C Time: 30 → 2 to 3 → 30 → 2 to 3 (Minutes) 5 cycles
8. Durability (mating / un-mating)	Contact resistance: 30 mΩ max.	30 cycles
9. Resistance to soldering heat	No deformation of components affecting performance.	Reflow: At the recommended temperature profile Manual soldering: 350°C for 3 seconds

Note 1: Current rating for header is 1A.

Note 2: Includes temperature rise caused by current flow.

Note 3: The term "storage" refers to products stored for long period of time prior to mounting and use. Operating temperature range and humidity range covers non-conducting condition of installed connectors in storage, shipment or during transportation.

Note 4: Information contained in this catalog represents general requirements for this Series. Contact us for the drawings and specifications for a specific part number shown.

Materials and Finishes

Product	Component	Material	Finish	Remarks
Socket	Insulators	Polyamide	Color : Black	UL94V-0
Crimp contact	Contact-socket	Phosphor bronze	Gold plated	————
Header	Insulator	Polyamide	Color : Black	UL94V-0
	Contact-blade	Phosphor bronze	Gold plated	————
Pull strap	Pull strap	PET	————	————

Ordering information

Connectors

DF24 # - * DS - 0.9 C

① ② ③ ④ ⑤ ⑥

① Series Name : DF24	④ Connector type DS : Double-row socket DP : Double-row header
② Form type Pin headers A : Standard type Sockets Blank : Standard type A : Pull strap version	⑤ Contact pitch : 0.9 mm
③ Number of contacts : 40, 50	⑥ Housing type C : Crimp housing V : Straight SMT header PTB : Pull strap (Note)

Note: The pull strap is an optional.

Contacts

DF24 - 2830 SCF A

① ② ③

① Applicable conductor 2830 : AWG 28 to 30 3234 : AWG 32 to 34 36 : AWG 36	② Packaging SCF : Socket contact / reel
	③ Plating A : Gold plated

Double-row header (SMT)

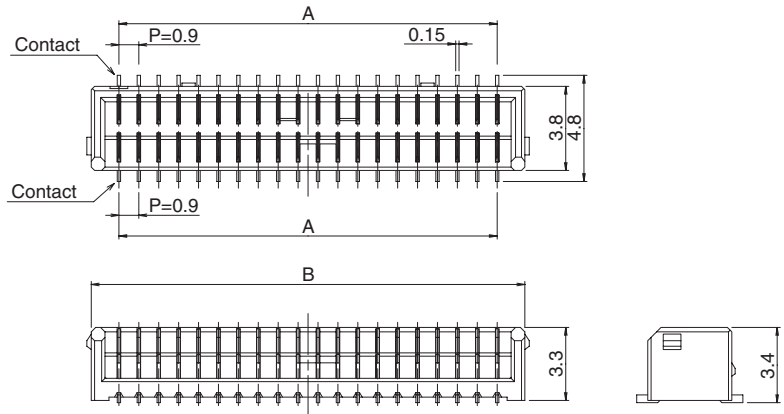
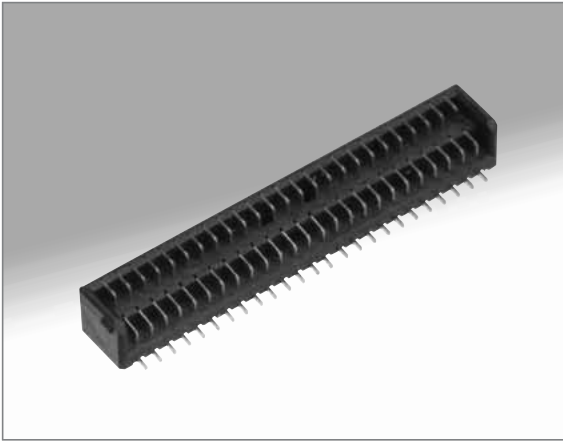

PCB mounting pattern

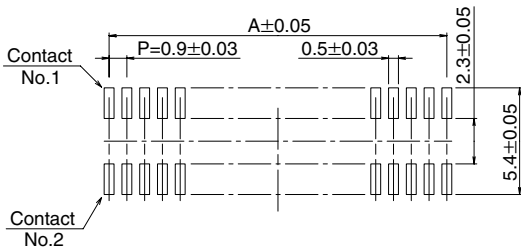

Specification number
 (51): Embossed tape packaging (1,000 pieces per reel).

Unit: mm

Part number	CL No.	Number of contacts	A	B	Packaging	RoHS
DF24A-40DP-0.9V(**)	687-3208-0-**-	40	17.1	19.6	1,000 pcs. / reel	YES
DF24A-50DP-0.9V(**)	687-3209-2-**-	50	21.6	24.1	1,000 pcs. / reel	

Packaging specifications

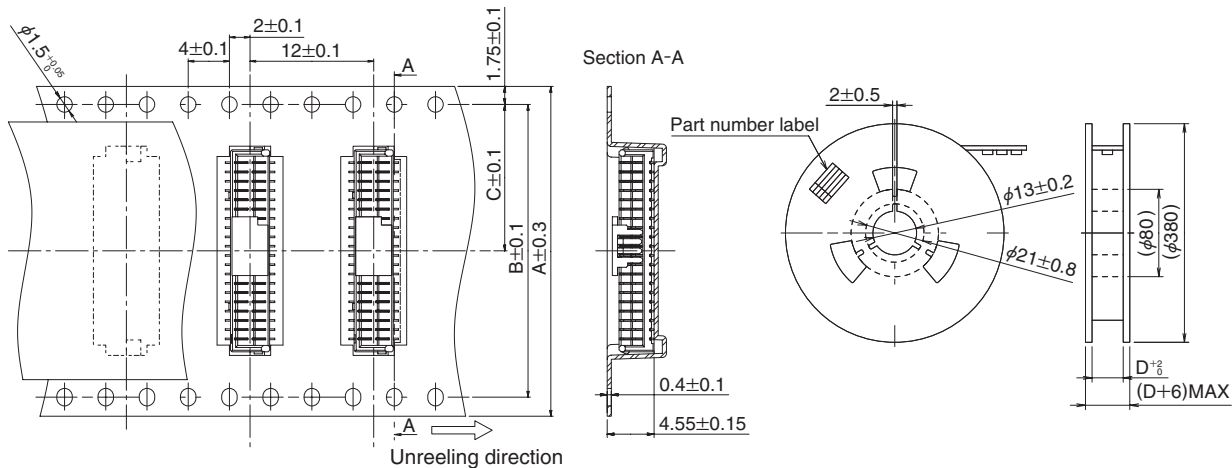

Unit: mm

Part number	Number of contacts	A	B	C	D
DF24A-40DP-0.9V(**)	40	32	28.4	14.2	32.4
	50	44	40.4	20.2	44.4

DF24 Series 0.9 mm Pitch Vertical Mating Board-to-Wire Connectors

Double-row socket

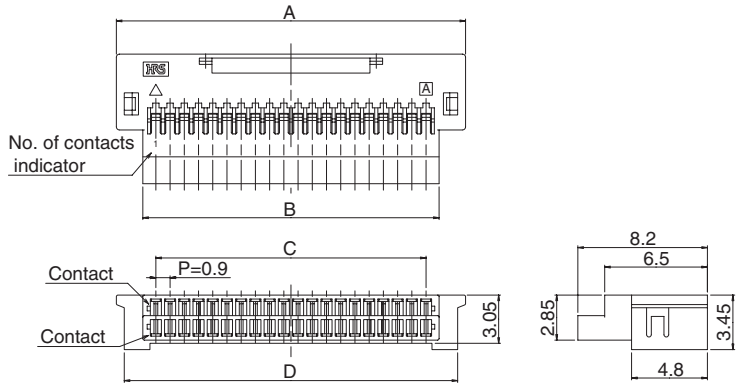
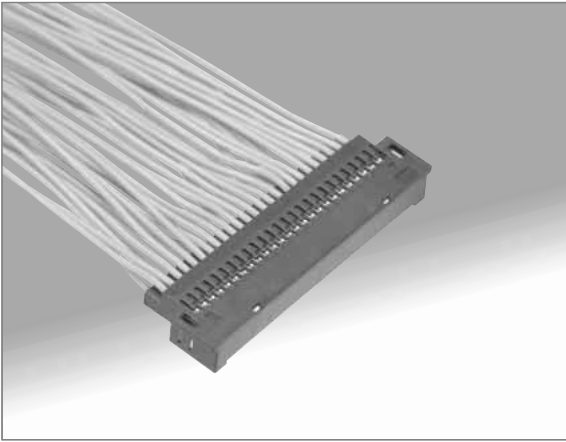

Unit: mm

Part number	CL No.	Number of contacts	A	B	C	D	Packaging	RoHS
DF24B-40DS-0.9C	687-3301-5	40	22.1	18.75	17.1	21.1	100 pcs. / bag	YES
DF24B-50DS-0.9C	687-3302-8	50	26.2	23.25	21.6	25.2	100 pcs. / bag	

Double-row socket (Pull strap)

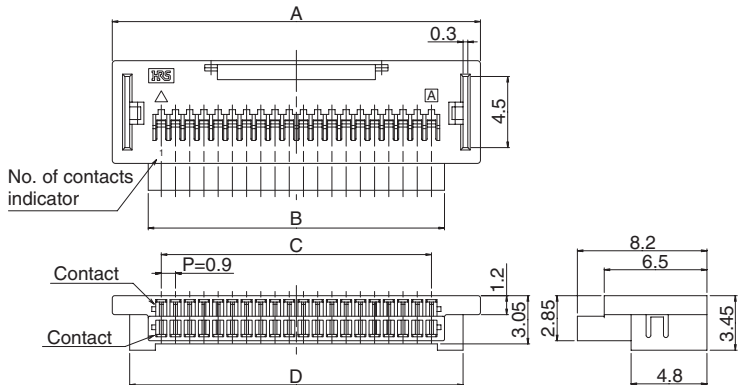
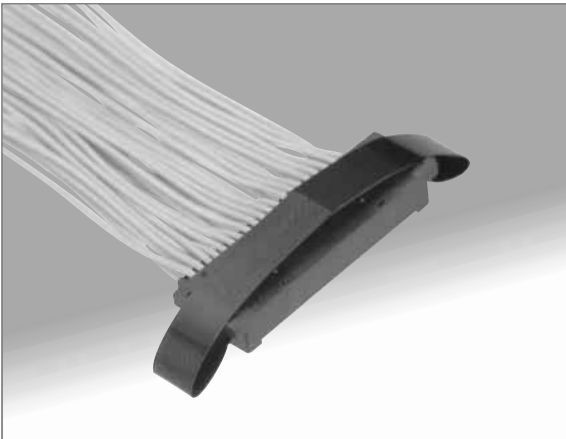

Unit: mm

Part number	CL No.	Number of contacts	A	B	C	D	Packaging	RoHS
DF24BA-50DS-0.9C	687-3304-3	50	27.4	23.25	21.6	25.2	100 pcs. / bag	YES

Note: Refer to page 5 for pull strap tab.

■Crimp contact

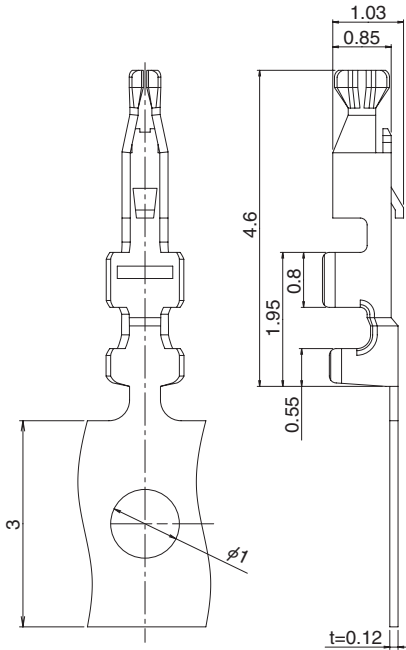

Part number	CL No.	Applicable wire size	Packaging	Quantity	Finish	RoHS
DF24-2830SCFA	687-3001-1	28 – 30	Reel	20,000	Gold plated	YES
DF24-3234SCFA	687-3004-0	32 – 34				
DF24-36SCFA	687-3003-7	36				

● Applicable wire (Tin plated annealed copper wire)

Wire size (Stranded wire conductor)	Jacket diameter
AWG28 (7 / 0.127mm)	0.6mm max
AWG30 (7 / 0.10 mm)	
AWG32 (7 / 0.08 mm)	
AWG36 (7 / 0.05 mm)	0.4mm max

Note: When using other than the recommended wire, contact your nearest Hirose representative.

● Tools

Type	Description	Part number	CL No.	Applicable contacts
Automatic	Applicator	AP105-DF24-2830S	901-4602-5	DF24-2830SCFA
		AP105-DF24-3234S	901-4592-3	DF24-3234SCFA
		AP105-DF24-36S	901-4606-6	DF24-36SCFA
	Press unit	CM-105	901-0005-4	_____
Contact extraction tool	DF-C-PO(B)	550-0179-2		DF24-****SCFA

■Pull strap

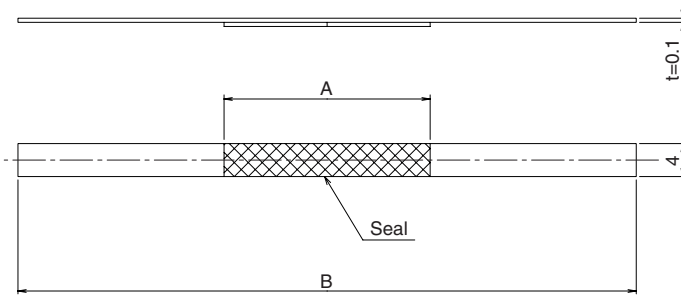

Applicable socket
 ※ [DF24BA-50DS-0.9C]

Unit: mm

Part number	CL No.	Number of contacts	A	B	Packaging	RoHS
DF24-50DS-PTB	687-3300-2	50	25	75	500 pcs. / bag	YES

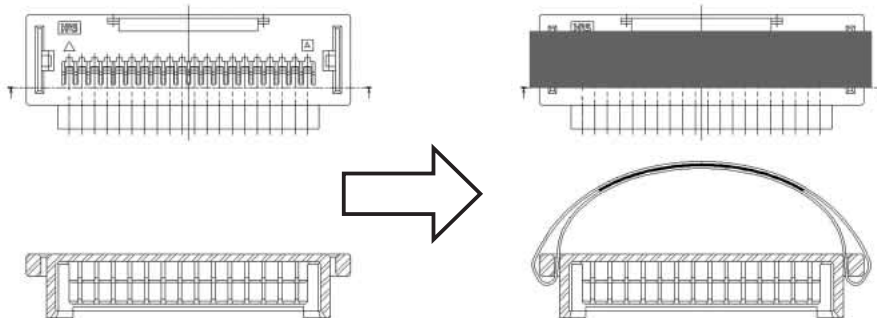

Before attachment of the pull strap

Pull strap attached

DF24 Series 0.9 mm Pitch Vertical Mating Board-to-Wire Connectors

■ Pull Strap Attachment Procedure

- ① With the adhesive side of the pull strap facing upward, pass both ends of the strap through the elongated openings at both ends of the socket.

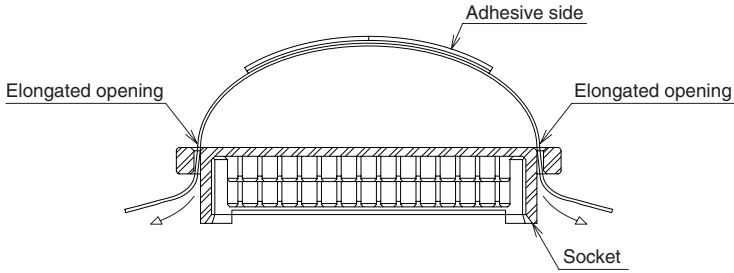

- ② Peel-off the protective paper on one side and place one end of the strap over exposed adhesive (as illustrated below), using the remaining paper side as the alignment guide.

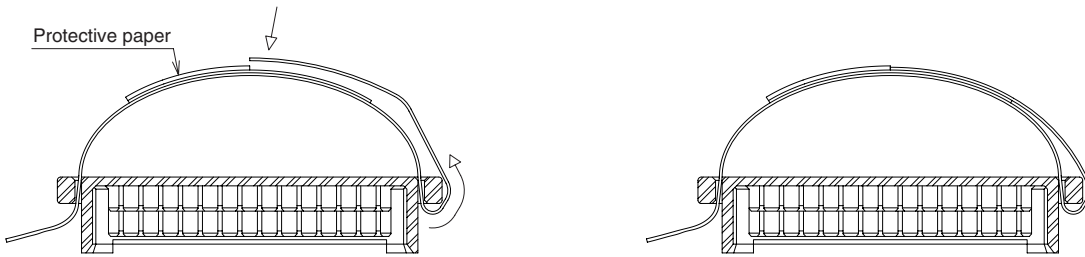

- ③ Peel-off the remaining protective paper and place the other end of the strap over the adhesive, using the already attached end as the alignment guide.

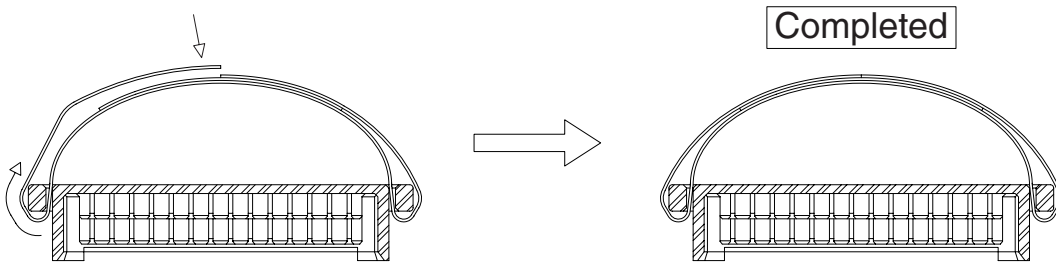

Usage recommendations and Precautions

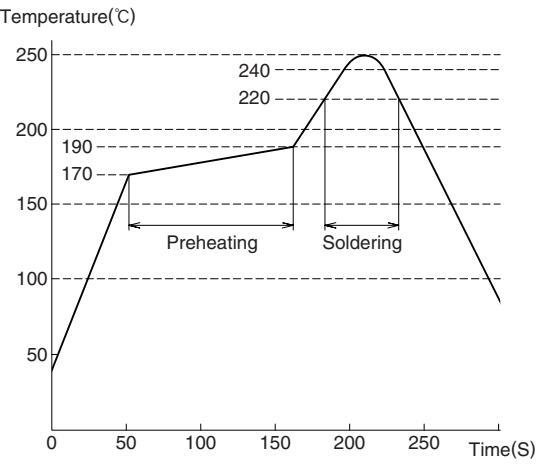
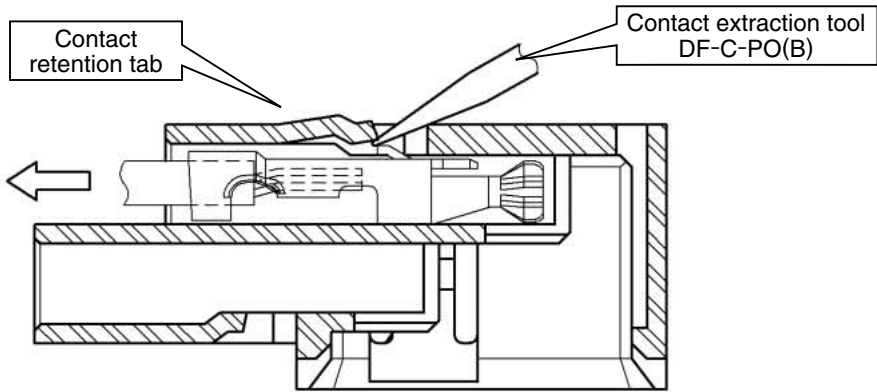
<p>1. Recommended temperature profile (Including Lead-free solder)</p>	 <div data-bbox="1036 285 1382 551" style="border: 1px solid black; padding: 5px;"> <p>Reflow conditions</p> <p>Preheating: 180±10°C 60~20sec.</p> <p>Soldering: 250°C max. 240°Cmin. 20sec. max. 220°Cmin. 60sec. max.</p> </div> <p>Note 1: Up to 2 cycles of Reflow soldering are possible under the same conditions, providing that there is a return to normal temperature between the first and second cycle. Note 2: The temperature profile indicates the board surface at the point of contacts with the connector terminals.</p>
<p>2. Recommended manual soldering</p>	<p>Manual soldering: 300±10°C for 3 seconds</p>
<p>3. Recommended screen thickness and opening area ratio (Pattern area ratio)</p>	<p>Thickness: 0.12mm Opening area ratio: 80%</p>
<p>4. Board warpage</p>	<p>Maximum of 0.03mm at the connector center, with both ends of the connector as reference points.</p>
<p>5. Cleaning conditions</p>	<p>Refer to "Nylon Connector Use Handbook".</p>
<p>6. Wire preparation and contact crimping</p>	<p>Refer to "Nylon Connector Use Handbook". The crimp contacts are of a very small form and because of this, crimping should be performed carefully based on the content of the Crimping Conditions Table and the Crimping Quality Standards Manual.</p>
<p>7. Precautions</p>	<p>■ Removal of the inserted socket contacts</p> <ul style="list-style-type: none"> * Using the socket contact extraction tool (DF-C-PO(B)) carefully lift the contact retention tab on the insulator housing, as shown on the Fig.1 and pull-out the wire. * Lift the tab ONLY enough to remove the contact. Exercise caution NOT to deflect too much. The tab should return to its original position after the contact is removed. The tab must be in its original position before inserting the new socket contact.  <p style="text-align: center;">Fig. 1. Contact Removal</p>

7. Precautions

■ Connector Mating/Un-mating

- * Hold the socket at both ends (as illustrated on Fig.2) when mating or un-mating. The mating/un-mating of the connectors must be within the indicated angle of 20° on both axis.

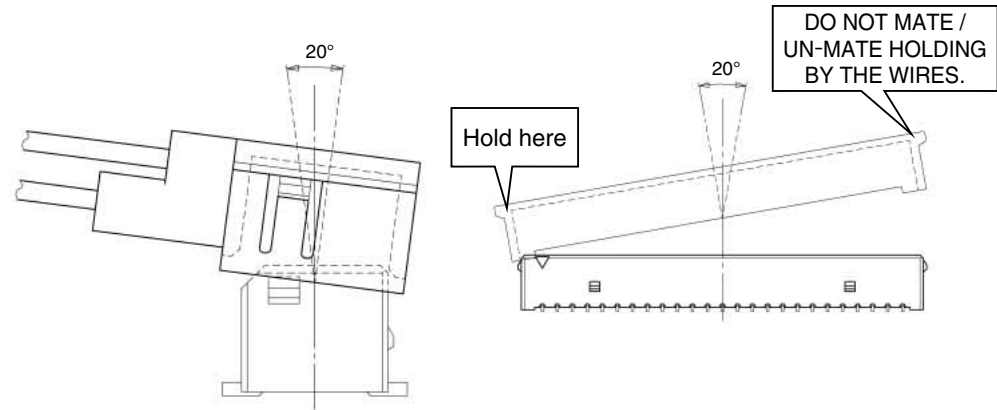

Fig. 2. Mating / Un-mating

■ Bundling of the Wires

- * To avoid wire damage or termination faults bundling of the wires should be at the distance of 20 mm min. from the socket (Fig. 3-1)
- * When bundling at the distance less than the recommended 20 mm, it is critical to avoid sharp bend radius (Fig. 3-2) or apply stretching or twisting forces (Fig. 3-3)

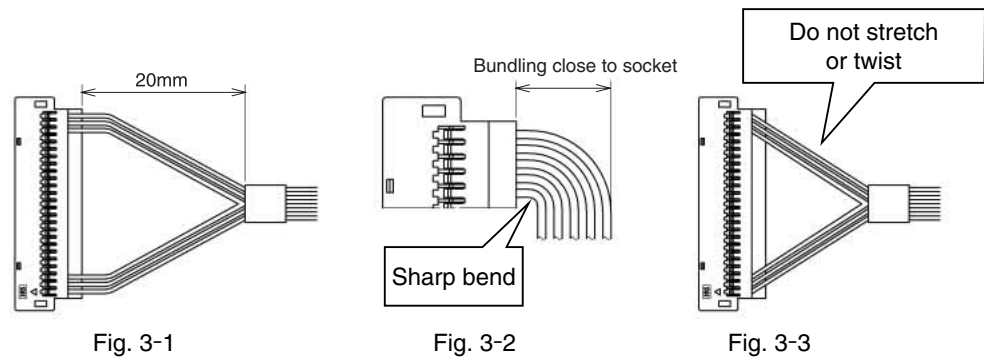

Fig. 3. Bundling requirements

- * Do not mate/un-mate connectors when not mounted on the board.
- * Do not use connector as the only support for the board.
- * Do not use flux compounds when hand soldering.
- * Slight color shade difference of the insulator bodies will not affect the form, fit or function of the connectors.