

Features

- n Constant Coupling - Within ± 0.5 dB Max.
- n MIL-STD-202 Screening Available

Description

Bi-Directional Couplers offer the ability to couple the power in two directions while maintaining directivity.

SF-1 (CHS-134)

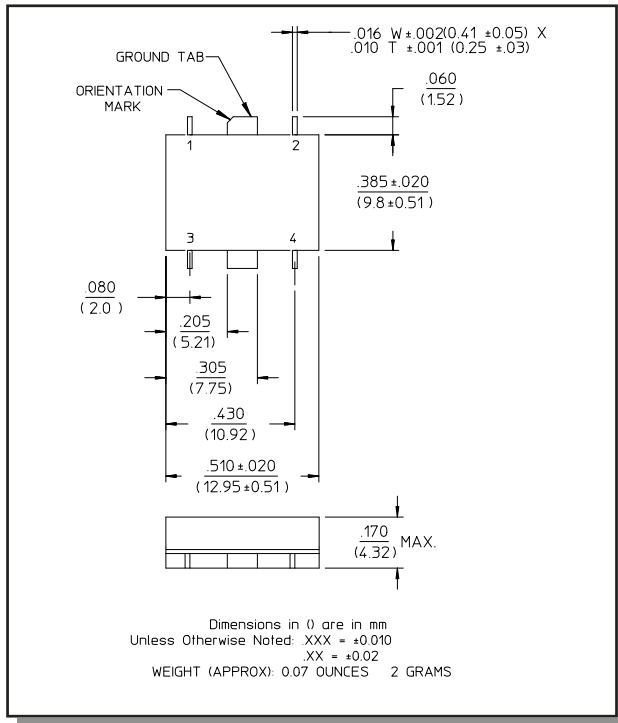

Pin Configuration (CHS-134)

Pin No.	Function	Pin No.	Function
1	C	3	A
2	B	4	D

FP-2 (CH-134)

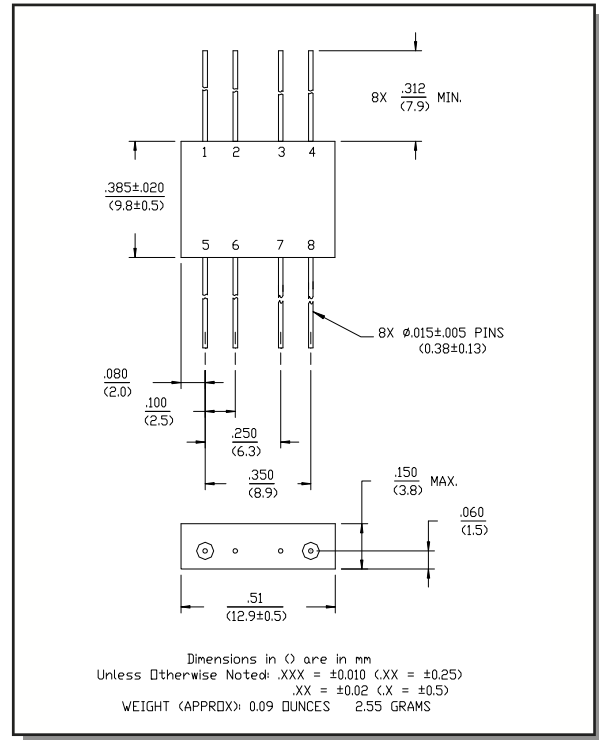

Pin Configuration (CH-134)

Pin No.	Function	Pin No.	Function
1	C	5	A
2	GND	6	GND
3	GND	7	GND
4	B	8	D

Electrical Specifications¹: $T_A = -55^{\circ}\text{C}$ to $+85^{\circ}\text{C}$

Parameter	Test Conditions	Frequency	Units	Min	Typ	Max
Coupling	Input to Output	—	dB	10.1	10.8	11.5
Coupling Flatness	—	—	dB	—	—	± 0.5
VSWR	All Ports	10 - 500 MHz 25 - 200 MHz	Ratio Ratio	— —	— —	1.8:1 1.5:1
Directivity	Both Directions	—	dB	20	—	—
Main Line Loss ²	—	—	dB	—	—	1.6
Input Power	—	—	Watt	—	—	1.0

- All specifications apply with 50 ohm source and load impedance.
 - Includes theoretical power split.
- This product contains elements protected by United States Patent number 3,426,298.

Functional Diagram (CH-134)

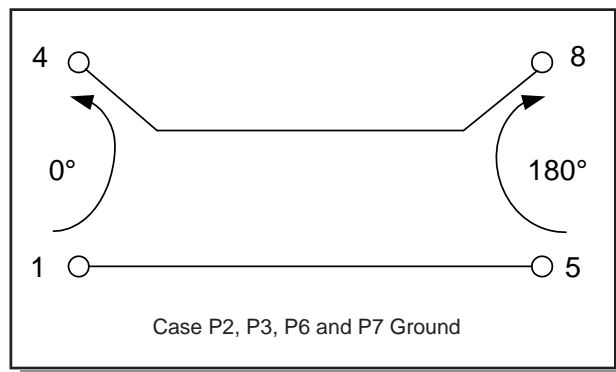

Functional Diagram (CHS-134)

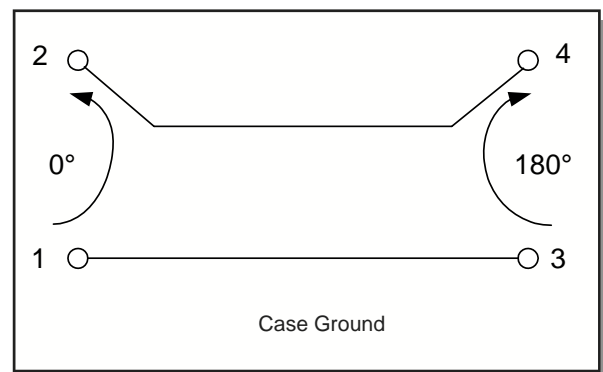

Typical Performance Curves

Main Line Loss

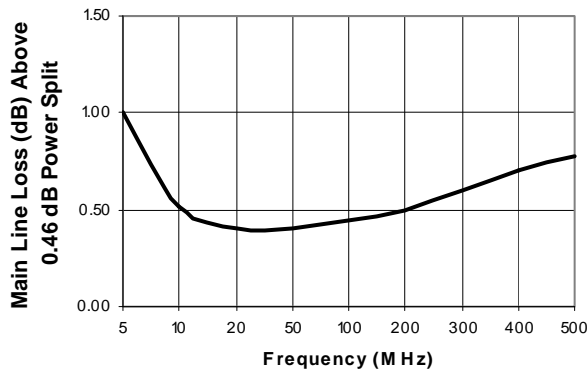

Directivity

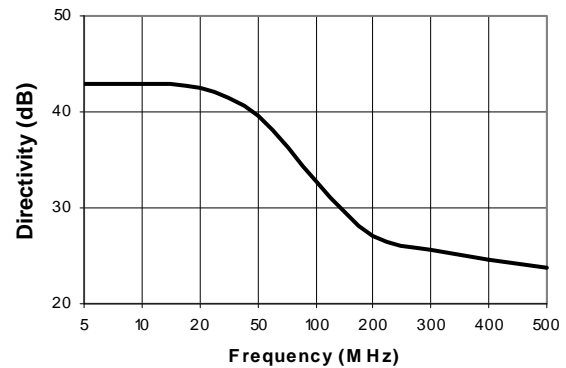

VSWR

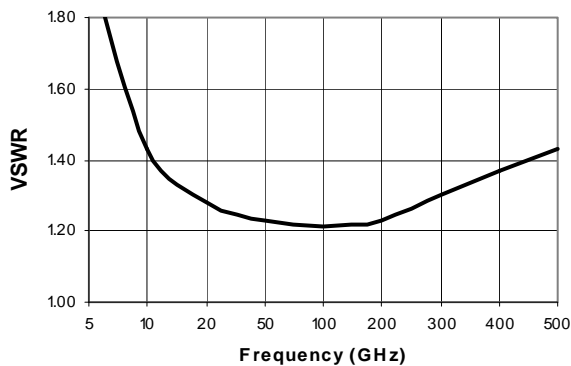

Coupling

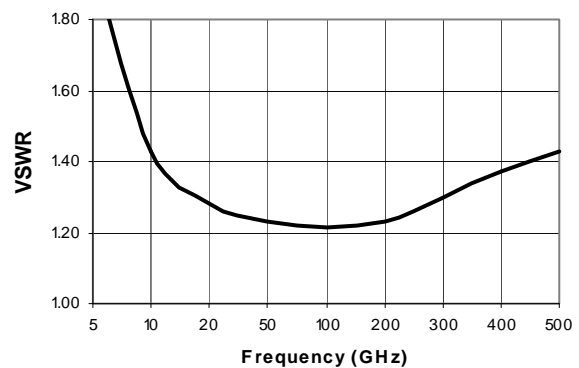

Ordering Information

Part Number	Package
CH-134 PIN	FP-2
CHS-134 PIN	SF-1