

36

361899

RAST 5 connectors, pitch 5.0 mm

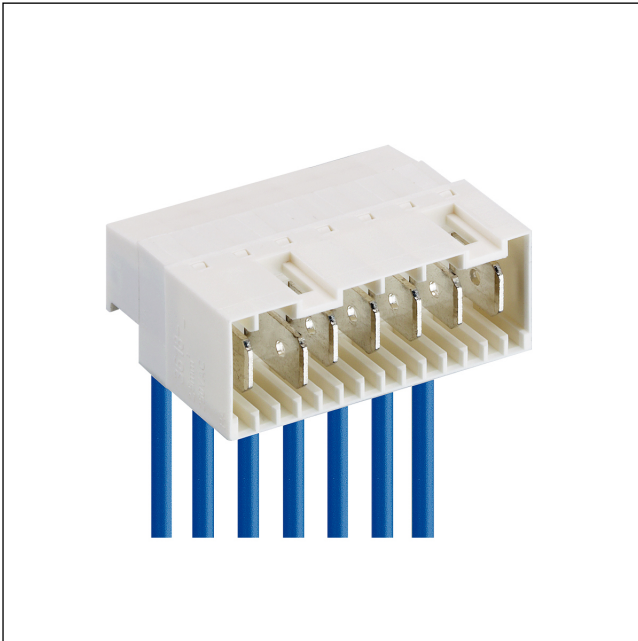

RAST 5 tab header, with screw terminal, with lift clamp with protection against misplacing, with test holes, cable departure opposite to lock, with pre-mating protective contact

State: Active

Approvals:



36 361899

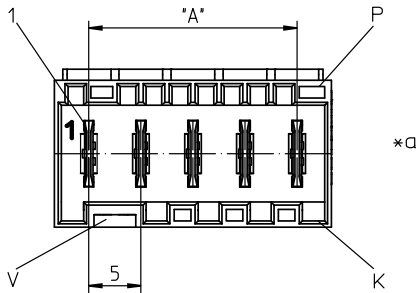

A-A

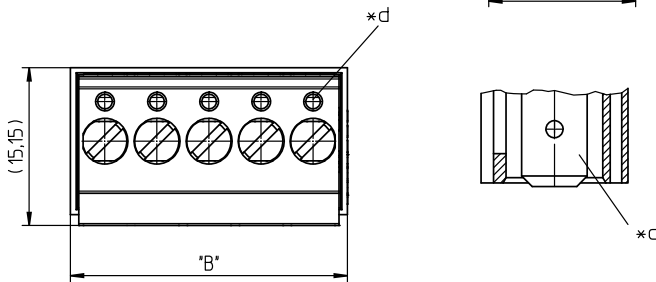
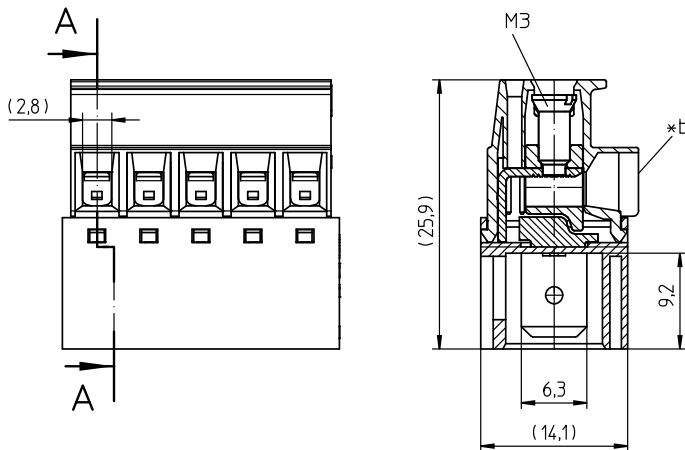

- *a K = keying
P = positioning
V = space for lock
- *b all screw clamps of the connector to be tightened with the indicated torque
- *c cable departure 90°
- *d pre-mating protective contact, protruding 1.5 mm, possible at any position
- *e hole for test spike \varnothing 1.3 mm

Environmental conditions

Temperature range -40 °C/+130 °C¹

¹ upper limit temperature (insulating body) RTI (electrical) of the UL Yellow Card

Materials

Insulating body PA GF, V-2 according to UL94¹
 Contact tab CuZn, tin-plated
 Clamp CuZn, nickel-plated
 Screw steel, zinc-plated and chromatiert

¹ component glow wire resistant (GWT 750 °C), testing acc. to IEC 60695-2-11, assessment acc. to IEC 60335-1 (flame < 2 s)

Mechanical data

Contact tab 6.3 x 0.8 mm according to DIN 42644
 Tightening torque screw 0,5 Nm
 Keying proposals at www.lumberg.com 











Connectable conductors for screw clamp

Section stranded wire 0,14-2,5 mm² (AWG 26-14)
 Section stranded wire with sleeve 0,25-2,5 mm² (AWG 24-14)
 Section solid wire 0,14-4,0 mm² (AWG 26-12)
 Stripping length 8 ± 1 mm

Electrical data (at T_{amb} 20 °C)

Contact resistance ≤ 5 mΩ
 Rated current 10 A (T_v 70 °C)
 Rated voltage 250 V AC
 Material group IIIa (IEC)/2 (UL) (CTI ≥ 250)
 Creepage distance 3,5 mm
 Clearance 3,5 mm
 Insulation resistance > 10 GΩ

Associated products

Counterparts
 3611  3615  3615-1
 3615-2  3615-3  3623
 3626  3680  3683
 3686  3687

36

361899

Designation	Pole Number	PU (Pieces)	MDQ (Pieces)	Dimensions	
				A (mm)	B (mm)
361899 02	2	200	1000	5	11.6
361899 03	3	200	1000	10	16.6
361899 04	4	200	1000	15	21.6
361899 05	5	200	1000	20	26.6
361899 06	6	200	1000	25	31.6
361899 07	7	200	1000	30	36.6

Designation to be completed by further details (e.g. for keying, color or material options).

Packaging:

in bulk, in a cardboard box