

Part No.

AL-513OR6C

Diff No.

5 mm

Round

Type : LED Lamps

Package Dimension :

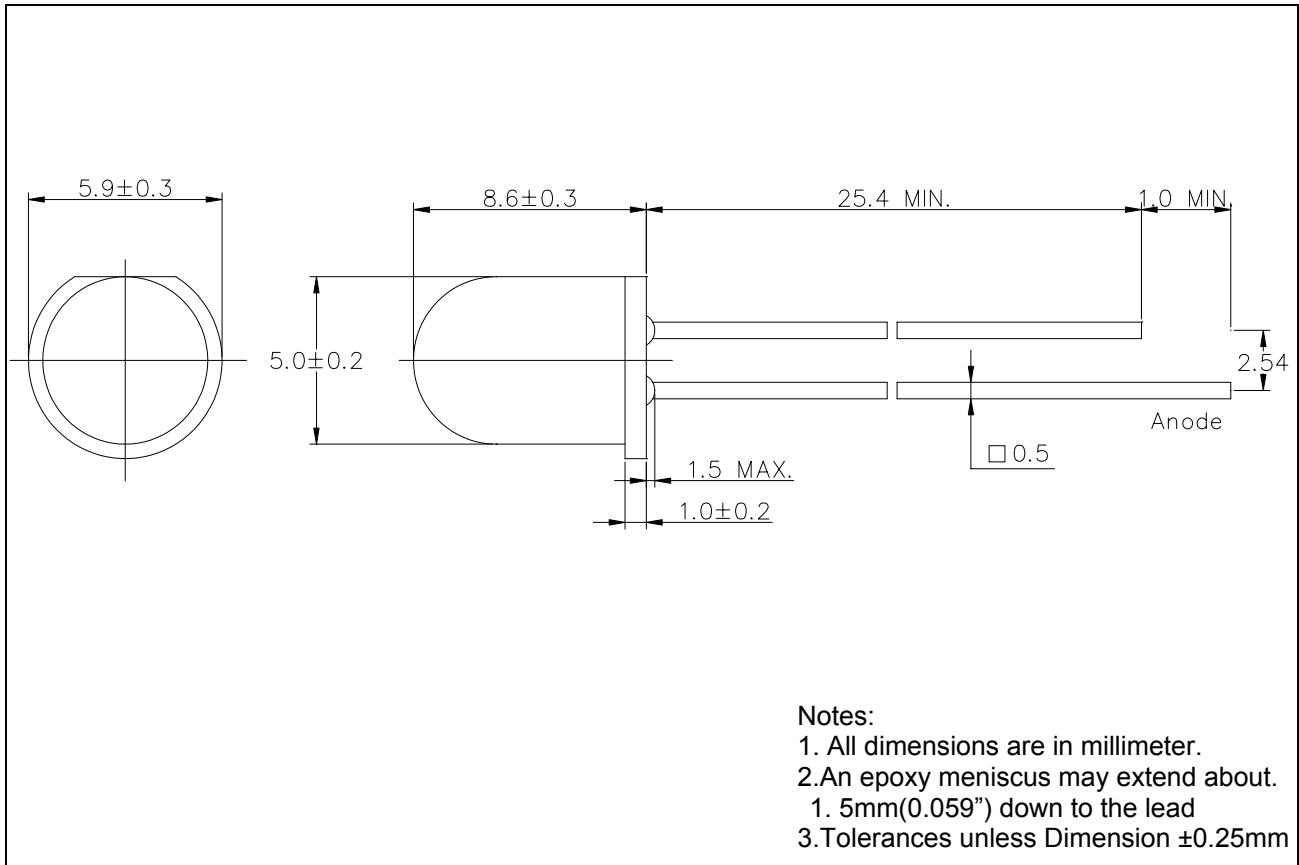

■ Features :

- Choice of various viewing angles.
- Available on Tape and Reel.
- Reliable and robust.

■ Descriptions :

- The series is specially designed for application requiring higher brightness.
- The LED lamps are available with different color, intensities, epoxy colors etc.

■ Applications :

- TV set
- Monitor
- Telephone

Part No.

AL-513OR6C

Diff No.

5 mm

Round

Type : LED Lamps

PART NO.	Chip		Lens Color
	Material	Emitted Color	
AL-513OR6C	AlGaInP	Ultra Red	Water Clear

■ Absolute Maximum Ratings at Ta=25°C

Parameter	Symbol	Rating	Unit
Continuous Forward Current	I _F	30	mA
Operating Temperature	T _{opr}	-40 to +85	°C
Storage Temperature	T _{stg}	-40 to +85	°C
Soldering Temperature	T _{sol}	260 ±5	°C
Electrostatic Discharge	ESD	1000	V
Power Dissipation	P _D	120	mW
Peak Forward Current (Duty 1/10@1KHz)	I _F (Peak)	100	mA
Reverse Voltage	V _R	5	V

■ Electronic Optical Characteristics :

Parameter	Symbol	Min.	Typ.	Max.	Unit	Condition
Luminous Intensity	I _V	15000	20000	/	mcd	I _F =20mA
Viewing Angle	2θ1/2	/	15	/	deg	I _F =20mA
Peak Wavelength	λ _p	/	630	/	nm	I _F =20mA
Dominant Wavelength	λ _d	/	625	/	nm	I _F =20mA
Spectrum Radiation Bandwidth	Δλ	/	30	/	nm	I _F =20mA
Forward Voltage	V _F	/	2.0	2.4	V	I _F =20mA
Reverse Current	I _R	/	/	10	μA	V _R =5V

Part No.

AL-513OR6C

Diff No.

5 mm

Round

Type : LED Lamps

■ Reliability test items and conditions :

NO	Item	Test Conditions	Test Hours/Cycle	Sample Size	Ac/Re
1	Solder Heat	TEMP : $260 \pm 5^{\circ}\text{C}$	5 SEC	76 PCS	0/1
2	Temperature Cycle	H : $+85^{\circ}\text{C}$ 30min ┆ 5min L : -55°C 30min	50 CYCLES	76 PCS	0/1
3	Thermal Shock	H : $+100^{\circ}\text{C}$ 5min ┆ 10set L : -10°C 5min	50 CYCLES	76 PCS	0/1
4	High Temperature Storage	TEMP : 100°C	1000 HRS	76 PCS	0/1
5	Low Temperature Storage	TEMP : -55°C	1000 HRS	76 PCS	0/1
6	DC Operating Life	TEMP : 25°C $I_{\text{F}}=20\text{mA}$	1000 HRS	76 PCS	0/1
7	High Temperature / High Humidity	85°C / 85%RH	1000 HRS	76 PCS	0/1

Part No.
5 mm

AL-513OR6C
Round

Diff No.
Type : LED Lamps

◆ TYPICAL ELECTRICAL-OPTICAL CHARACTERISTICS CURVES

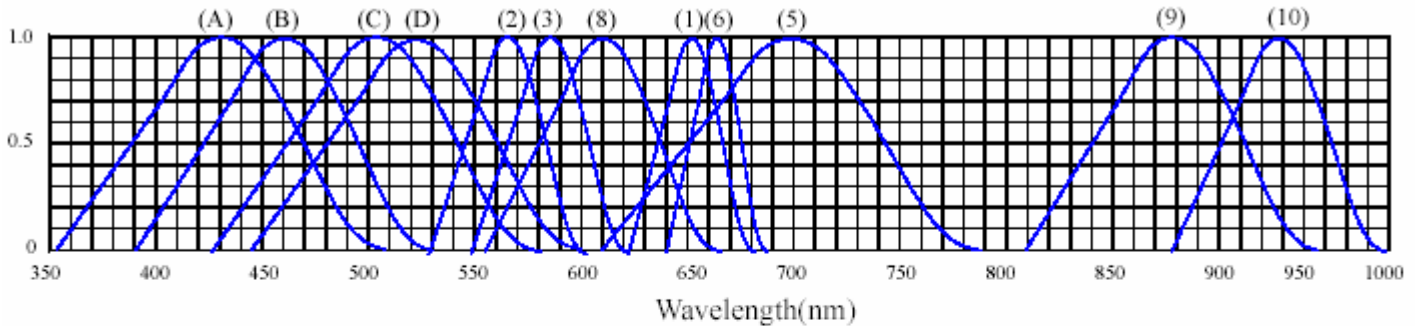
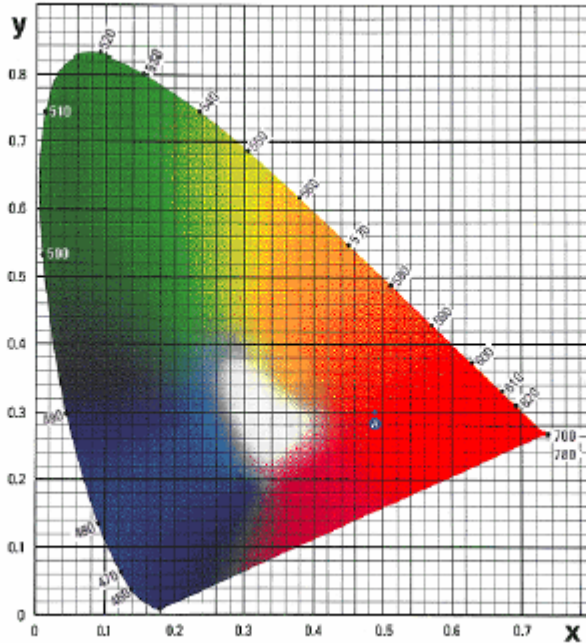

RELATIVE INTENSITY VS. WAVELENGTH(λ_p)

- | | |
|---|----------------------------------|
| (1) GaAsP/GaAs 655nm/Red | (9)- GaAlAs 880nm |
| (2) GaP 568nm/ Yellow Green | (10)-GaAs/GaAs&GaAlAs/GaAs 940nm |
| (3) GaAsP/GaP 585nm/Yellow | (A)- GaN 430nm/Blue |
| (4) GaAsP/GaP 635nm/Orange & Hi-Eff Red | (B)- InGaN 470nm/Blue |
| (5) GaP 700nm/Bright Red | (C)- InGaN 502nm/Ultra Green |
| (6) GaAlAs/GaAs 660nm/Super Red | (D)- InGaN 523nm/Ultra Green |
| (8) GaAsP/GaP 610nm/Super Red | |

Part No.

AL-513OR6C

Diff No.

5 mm

Round

Type : LED Lamps

◆ CHARACTERISTICS DIAGRAMS

FORWARD CURRENT VS. FORWARD VOLTAGE

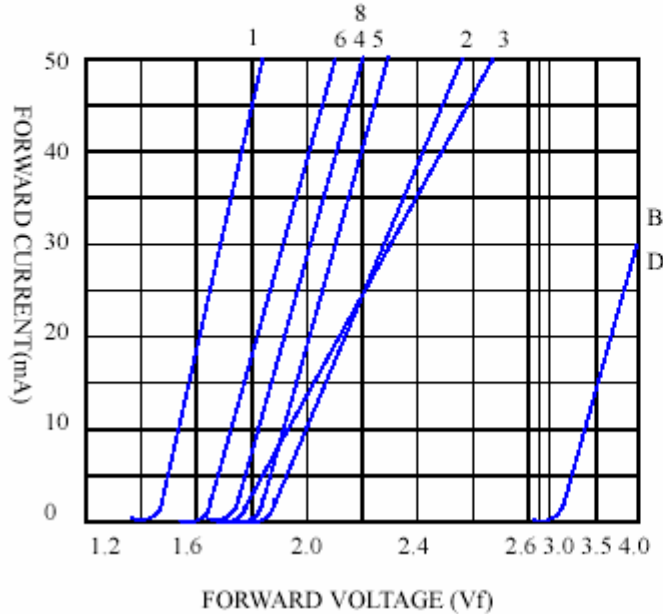

RELATIVE LUMINOUS INTENSITY VS. FORWARD CURRENT

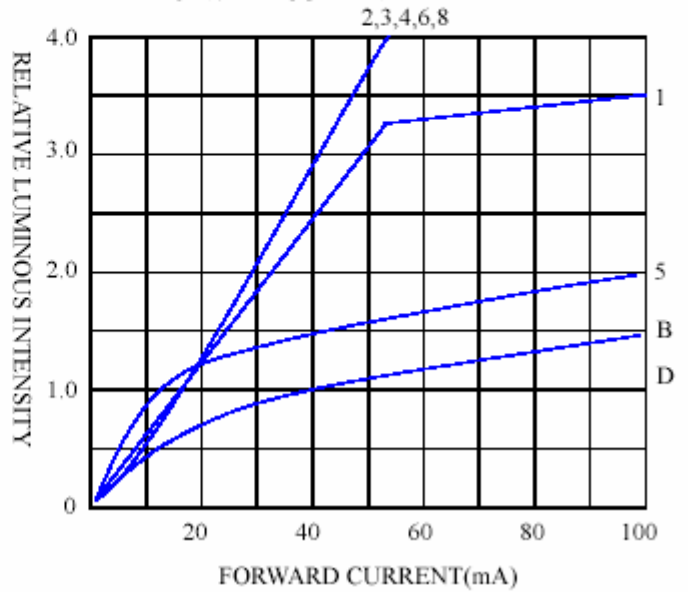

FORWARD CURRENT VS. AMBIENT TEMPERATURE

