

### DESCRIPTION

The CX-2V quartz crystal is a high quality tuning fork resonator for use in Pierce (single inverter) oscillators. The CX-2V is hermetically sealed in a rugged, miniature ceramic package, one-fourth the size of an eight-pin mini-DIP. The CX-2V crystal is manufactured using the STATEK-developed photolithographic process, and was designed utilizing the experience acquired by producing millions of crystals for industrial, commercial, military and medical applications.

### FEATURES

- Miniature tuning fork design
- High shock resistance
- Designed for low power applications
- Compatible with hybrid or PC board packaging
- Low aging
- Full military testing available
- Ideal for battery operated applications
- Designed and manufactured in the USA

### PACKAGE HANDLING

The CX crystal is hermetically sealed in a ceramic package. Normal handling and soldering precautions for small, low thermal mass parts are adequate when installing or testing CX crystals. CX crystals may be wave soldered, with proper precaution taken to avoid desoldering the leads. A slow machine rate or too high a pre-heat temperature or solder bath temperature can damage the crystals. **Lead to package solder interface temperature should not exceed 175°C, glass lid to package seal rim temperature should not exceed 210°C.** If the seal rim reaches temperatures above the maximum specified, the package may lose its hermeticity. Loss of hermeticity results in a frequency decrease and motional resistance increase.

### EQUIVALENT CIRCUIT

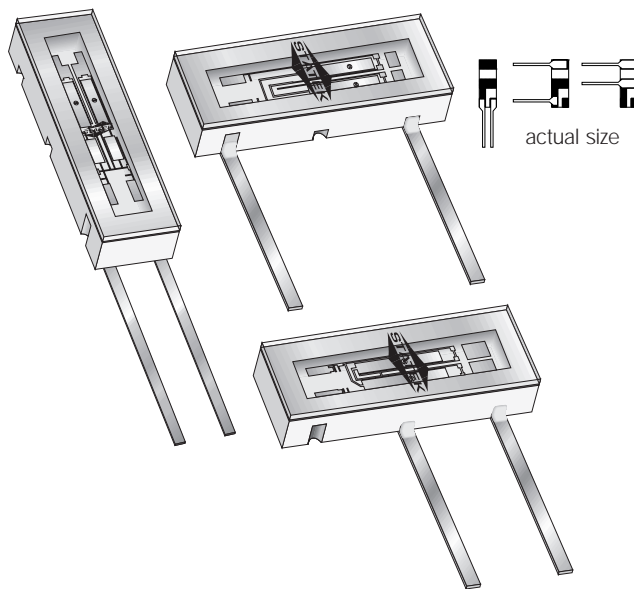
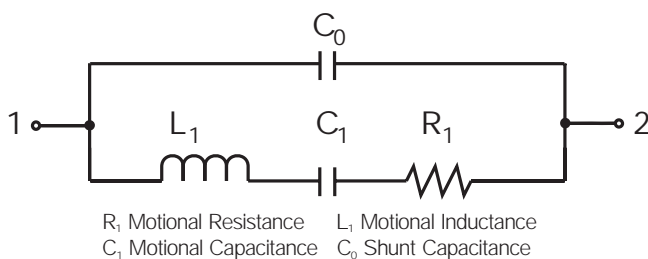

### PACKAGE DIMENSIONS

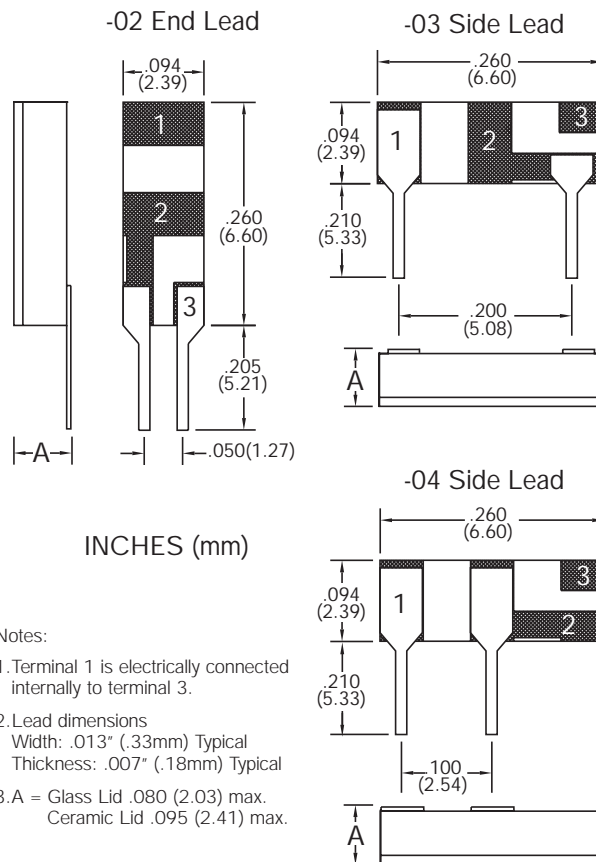

## SPECIFICATIONS

Specifications are typical at 25°C unless otherwise noted.  
Specifications are subject to change without notice.

Frequency Range	16 kHz to 600 kHz
Functional Mode	Tuning Fork (Flexure)
Calibration Tolerance* (see below)	A, B or C
Motional Resistance ( $R_1$ )	See Figure 1 MAX.: 16-24.9 kHz, 2x Typ. 25-600 kHz, 2.5x Typ.
Motional Capacitance ( $C_1$ )	Figure 2
Quality Factor (Q)	Figure 3 Min. is 0.25x Typ.
Shunt Capacitance ( $C_0$ )	2.0 pF MAX.
Drive Level	16-24.9 kHz 0.5 $\mu$ W MAX. 25-600 kHz 1.0 $\mu$ W MAX.
Turning Point ( $T_0$ )**	Figure 4
Temperature Coefficient (k)	-0.035 ppm/°C <sup>2</sup>
Aging, first year	5ppm MAX.
Shock***	1,000g peak, 1msec., 1/2 sine
Vibration, survival***	10g rms, 20-2,000 Hz random
Operating Temperature	-10°C to +70°C Commercial -40°C to +85°C Industrial -55°C to +125°C Military
Storage Temperature	-55°C to +125°C
Max Process Temperature	See package handling

\* Tighter frequency calibration available.  
\*\* Other turning point available.  
\*\*\* Higher shock and vibration available.

### CX-2V Crystal Calibration Tolerance at 25°C

	Frequency Range (kHz)			
Calibration	16-74.9	75-169.9	170-249.9	250-600
A	± 0.003%	± 0.005%	± 0.01%	± 0.02%
B	± 0.01%	± 0.01%	± 0.02%	± 0.05%
C	± 0.1%	± 0.1%	± 0.2%	± 0.5%

Load Capacitance ( $C_L$ ), Used to Calibrate CX-2V  
(other  $C_L$  available)

Frequency Range (kHz)	Load Capacitance (pF)	Frequency Range (kHz)	Load Capacitance (pF)
16-24.9	10	100.1-179.9	5
25-54.9	9	180-600	4
55-100.0	8		

## HOW TO ORDER CX-2V LEADED CRYSTALS

CX-2V	-03	32.768 kHz	( A / I )
"S" if special or custom design. Blank if Std.	Leads 02 03 04	Frequency	Calibration Tolerance* @ 25°C (A) (B) (C)
			Temp. Range: C = Commercial I = Industrial M = Military S = Specify

\*Other calibration fill in ppm.

FIGURE 1  
CX-2V TYPICAL MOTIONAL RESISTANCE ( $R_1$ )

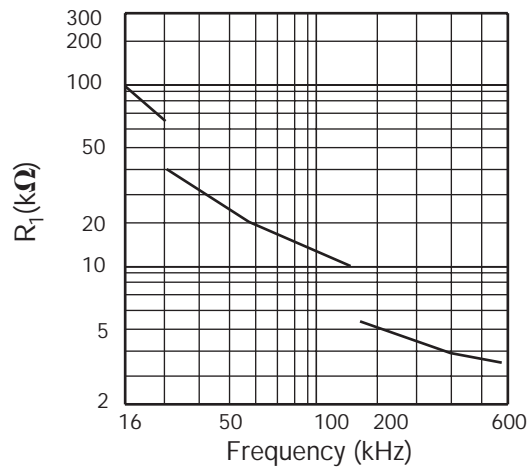

FIGURE 2  
CX-2V TYPICAL MOTIONAL CAPACITANCE ( $C_1$ )

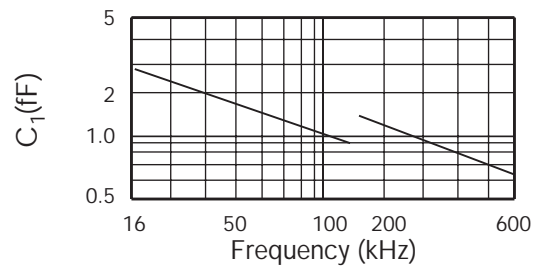

FIGURE 3  
CX-2V TYPICAL QUALITY FACTOR (Q)

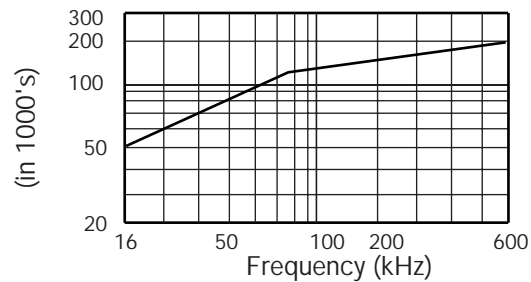
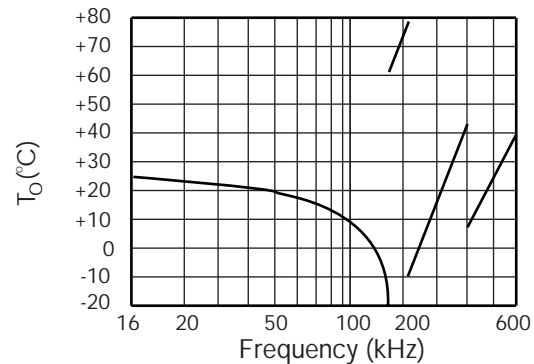

FIGURE 4  
CX-2V TYPICAL TURNING POINT TEMP. ( $T_0$ )



Note: Frequency (f) deviation from frequency ( $f_0$ ) @ turning point

$$\frac{f-f_0}{f_0} = k(T-T_0)^2$$

## PACKAGING

CX-2V-Leaded - Tray Pack (Standard)