

KEMET, HHBC, Choke, 54 uH, 20%

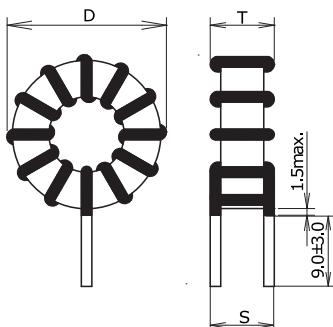

General Information	
Series:	HHBC
Style:	Through-Hole Toroid
Description:	Normal Mode Choke Coil. AC Line Filter.
Features:	Noise Solution, Switching Power Supply Outlets, DC-DC Converter
RoHS:	Yes
Lead:	Wire Leads
Core:	Ferrite
Miscellaneous:	35 (K) Temperature Rise Max.

Dimensions	
D	41.2mm MAX
T	19.5mm MAX
S	14mm NOM
LL	9mm +/-3mm
G	1.5mm MAX
Wire Size	1.7mm

Specifications	
Inductance:	54 uH
Inductance Tolerance:	20%
Temperature Range:	-40/+125C
Rated Temperature:	125C
Current:	12 A (MAX)

Packaging Specifications	
Weight:	56 g
Packaging:	Tray
Packaging Quantity:	80