

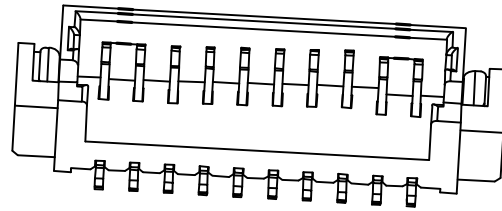

REV.	ECN NO OR DESCRIPTION	REVISED	DATE

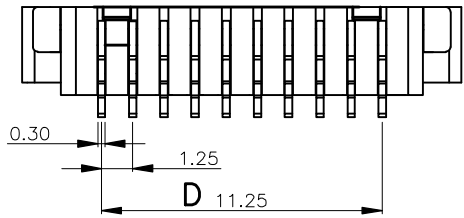

3D VIEW

Specifications:

1. Rated Voltage : 125V AC/DC
2. Rated Current : 1A AC,DC
3. Withstand Voltage : 200V AC/minute
4. Contact Resistance : 50mΩ(MAX.)
5. Insulation Resistance : 100MΩ(MIN.)
6. Storage Temperature Range: -40°C~+85°C;
7. Operation Temperature Range: -25°C~+70°C;

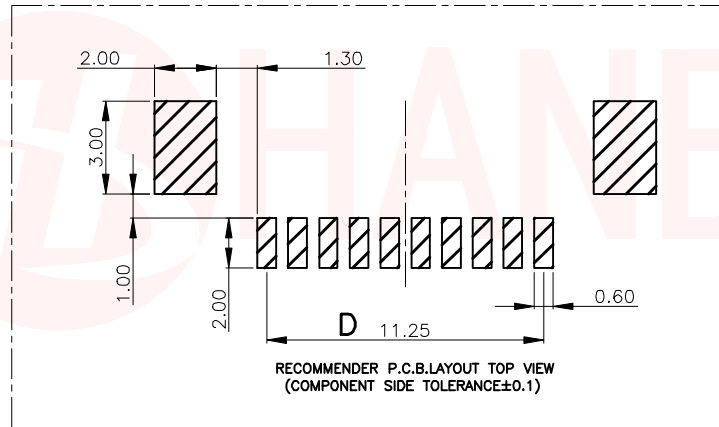
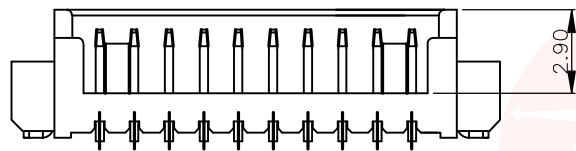

PIN数	A±0.1	B±0.1	C±0.1	D±0.1
2A	7.50	3.20	4.50	1.25
3A	8.75	4.45	5.75	2.50
4A	10.00	5.70	7.00	3.75
5A	11.25	6.95	8.25	5.00
6A	12.50	8.20	9.50	6.25
7A	13.75	9.45	10.75	7.50
8A	15.00	10.70	12.00	8.75
9A	16.25	11.95	13.25	10.00
10A	17.50	13.20	14.50	11.25

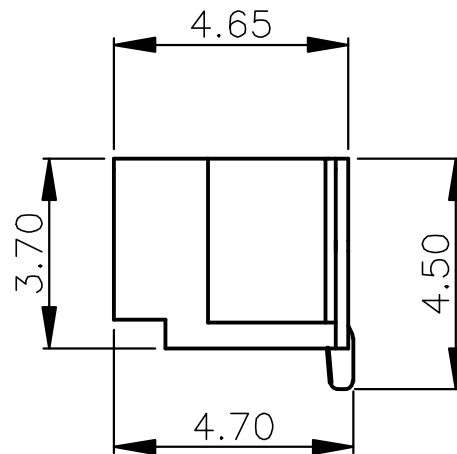
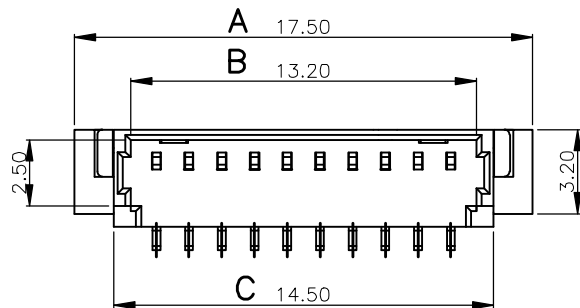
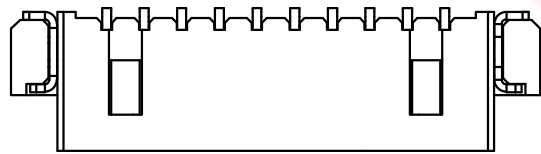

3	插片	黄铜H65	镀镍锡	
2	插针	黄铜H65	镀镍锡	
1	基座	LCP	本色	
序号	品名	材质	电镀/颜色	备注

UNLESS OTHERWISE SPECIFIED TOLERANCES



东莞市汉博电子科技有限公司  
DONGGUAN HANBO TECHNOLOGY CO., LTD

DECIMALS: X :±0.25 X.X :±0.15 X.XX :±0.05  
ANGLES: X :±2° X.X :±1°

TITLE	WAFER 1.25引脚			
DWN	xiong	PART NO. WAFER-125L-NA		
CHKD	lee	SCALE:1:1	UNIT: mm	
APVD	wang	SIZE: A4	SHEET:1OF 1	REV: A4

CUSTOMER COPY