

A30QS

SEMICONDUCTOR PROTECTION FUSES



A30QS Amp-Trap® Semiconductor Protection fuses are intended for the protection of Power Semiconductors such as Diodes, Phase Control SCR's and other Power Semiconductor devices. The A30QS is recommended for new applications providing solutions for your critical protection needs at 300V and less semiconductors.

Features/Benefits

- **Low I²t** minimizes damage to protected component on short circuit
- **Controlled arc Voltage** reduces stress to circuit components during fuse clearing
- **Choice of mounting types** helps in equipment design

HIGHLIGHTS:

- Fast Acting
- Current Limiting
- Low I²t
- Indicator Options Available
- Superior DC Capabilities

APPLICATIONS:

- Protection of 300 volt (or less) heavy duty rectifiers and similar heavy duty power supplies



Single Pole Fuse Blocks for A30QS Fuses

FUSE AMPERE RATING	FUSE BLOCK CATALOG NUMBER
1-30	70316
31-60	P243G
61-100	P243
101-200	P243
201-400	P243G
401-600	P243G



Ratings

- **AC:** 1- 4500A
300VAC, 200kA I.R.
- **DC:** 300VDC, 100kA I.R.
L/R= 10ms

Approvals

- UL Recognized Component
- AC: UL Guide No. JFHR2 (35-4500A)
- CSA

Catalog Numbering System

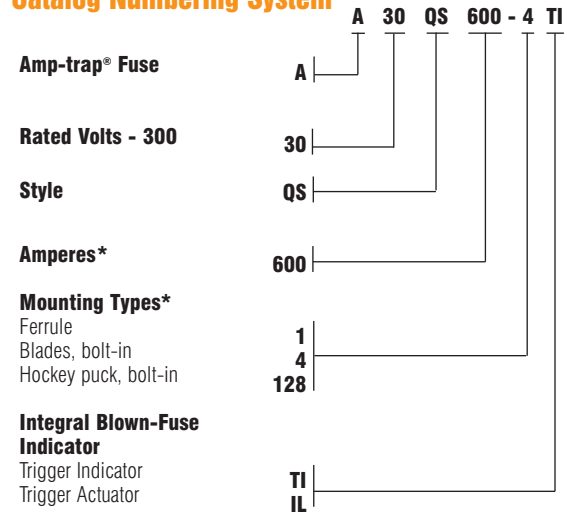

* For ampere ratings and types not listed, call Technical Services.

D

A30QS

SEMICONDUCTOR PROTECTION FUSES

Standard Fuse Ampere Ratings, Catalog Numbers

AMPERE RATING	CATALOG NUMBER	OUTLINE FIG.	AMPERE RATING	CATALOG NUMBER	OUTLINE FIG.	AMPERE RATING	CATALOG NUMBER	OUTLINE FIG.
1	A30QS1-1	1	100	A30QS100-4TI	3	600	A30QS600-4TI	3
2	A30QS2-1	1	125	A30QS125-4	3	600	A30QS600-4IL	4
3	A30QS3-1	1	130	A30QS130-4	3	700	A30QS700-4	4
4	A30QS4-1	1	150	A30QS150-4	3	700	A30QS700-128	5
5	A30QS5-1	1	150	A30QS150-4TI	3	800	A30QS800-4	3
6	A30QS6-1	1	175	A30QS175-4	3	800	A30QS800-4IL	4
7	A30QS7-1	1	200	A30QS200-4	3	800	A30QS800-128	5
8	A30QS8-1	1	200	A30QS200-4TI	3	1000	A30QS1000-128	5
10	A30QS10-1	1	225	A30QS225-4	3	1000	A30QS1000-128IL	5
12	A30QS12-1	1	250	A30QS250-4	3	1200	A30QS1200-128	5
15	A30QS15-1	1	250	A30QS250-4TI	3	1500	A30QS1500-128	7
20	A30QS20-1	1	300	A30QS300-4	3	1500	A30QS1500-128IL	7
25	A30QS25-1	1				1600	A30QS1600-128	6
30	A30QS30-1	1	300	A30QS300-4TI	3	2000	A30QS2000-128	6
35	A30QS35-1	2	350	A30QS350-4	3	2000	A30QS2000-128IL	7
40	A30QS40-4	2	400	A30QS400-4	3	2500	A30QS2500-128	6
50	A30QS50-4	2	400	A30QS400-4IL	4	2500	A30QS2500-128IL	7
60	A30QS60-4	2	400	A30QS400-4TI	3	3000	A30QS3000-128	6
70	A30QS70-4	3	450	A30QS450-4	3	3500	A30QS3500-128	6
80	A30QS80-4	3	500	A30QS500-4	3	3500	A30QS3500-128IL	7
90	A30QS90-4	3	550	A30QS550-4	3	4000	A30QS4000-128	6
100	A30QS100-4	3	600	A30QS600-4	3	4500	A30QS4500-128	6

For ampere ratings and styles not listed, call Technical Services.

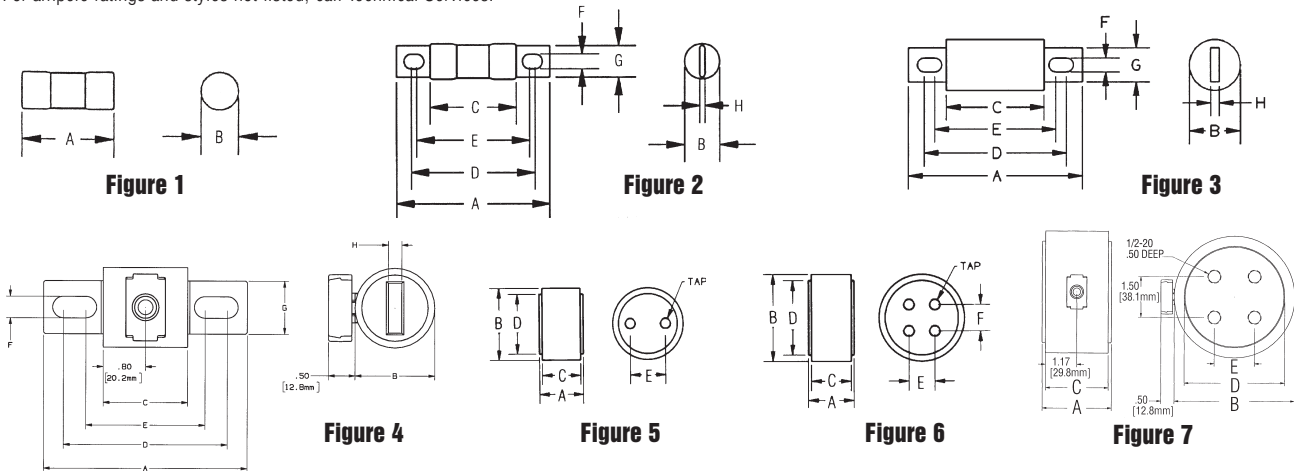

Dimensions

OUTLINE REF.	MOUNTING TYPE	FIG.	DIMENSIONS - INCHES (mm)								TAP
			A	B	C	D	E	F	G	H	
A30QS1 to 30	1		2.00 (51)	0.56 (14)	-	-	-	-	-	-	-
A30QS35 to 60	4	2	3.19 (81)	.081 (21)	1.63 (41)	2.50 (64)	2.25 (58)	0.34 (9)	.72 (18)	0.13 (3)	-
A30QS70 to 200	4	3	3.13 (80)	1.22 (31)	1.63 (41)	2.44 (62)	2.31 (59)	0.31 (8)	1.00 (25)	0.19 (5)	-
A30QS225 70 700	4, 4IL*	3,4*	3.84 (98)	1.50 (38)	1.59 (40)	2.91 (74)	2.28 (58)	0.41 (10)	1.00 (25)	0.25 (6)	-
A30QS700 to 1200	128	5	2.59 (66)	3.00 (76)	2.34 (59)	2.50 (64)	1.50 (38)	-	-	-	3/8-24-1/2 Deep (2)
A30QS1500 to 2500	128, 128IL*	6, 7*	2.59 (66)	3.50 (89)	2.34 (59)	3.00 (76)	1.50 (38)	1.50 (38)	-	-	3/8-24-1/2 Deep (4)
A30QS3000 to 4500	128, 128IL*	6, 7*	2.59 (66)	4.50 (114)	2.34 (59)	3.75 (95)	1.50 (38)	1.50 (38)	-	-	1/2-20-1/2 Deep (4)

* Optional (IL) Actuator

A30QS

SEMICONDUCTOR PROTECTION FUSES

I²t Data

AMPERE RATING	MELTING I ² t (A ² s X 10 ³)	MAX CLEARING I ² t		AMPERE RATING	MELTING I ² t (A ² s X 10 ³)	MAX CLEARING I ² t	
		@ 250VAC (A ² s X 10 ³)	@ 300 VAC (A ² s X 10 ³)			@ 250VAC (A ² s X 10 ³)	@ 300 VAC (A ² s X 10 ³)
1	0.0001	0.0002	0.0003	175	2.1	7.6	10
2	0.0004	0.0009	0.001	200	3.0	11	15
3	0.001	0.0018	0.002	225	3.6	16	22
4	0.002	0.0035	0.004	250	4.4	19	25
5	0.004	0.007	0.008	275	5.6	23	31
6	0.001	0.007	0.010	300	6.9	27	37
7	0.001	0.007	0.010	350	12	45	62
8	0.002	0.010	0.013	400	16	61	83
10	0.003	0.013	0.018	450	25	95	130
12	0.004	0.018	0.025	500	30	120	160
15	0.006	0.032	0.045	550	36	140	190
20	0.009	0.053	0.075	600	47	170	230
25	0.017	0.09	0.13	700	50	190	260
30	0.027	0.15	0.21	800	67	240	330
35	0.09	0.61	0.90	900	83	290	380
40	0.13	0.83	1.2	1000	100	350	460
45	0.15	1.0	1.5	1200	200	680	880
50	0.21	1.4	2.0	1500	330	1100	1400
60	0.29	1.9	2.7	1600	390	1300	1690
70	0.24	1.2	1.6	1800	450	1500	2000
80	0.42	1.9	2.6	2000	590	2000	2600
90	0.53	2.3	3.2	2500	920	3100	4000
100	0.74	3.0	4.1	3000	1200	3600	4700
125	1.2	4.6	6.3	3500	1700	5000	6500
130	1.2	4.6	6.3	4000	2200	6000	8600
150	1.9	6.8	9.3	4500	2800	8400	11000

Peak Arc Voltage

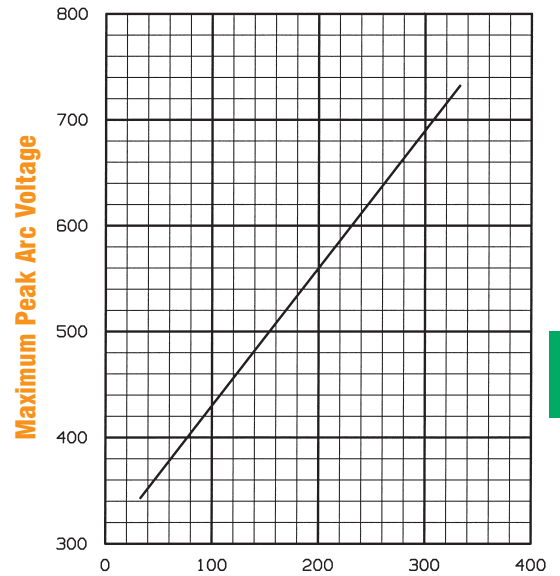

D

I²t vs. Working Voltage

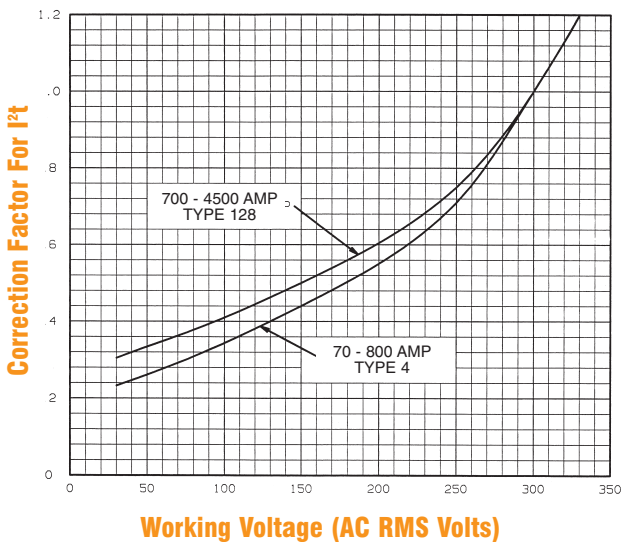

I²t vs. Working Voltage

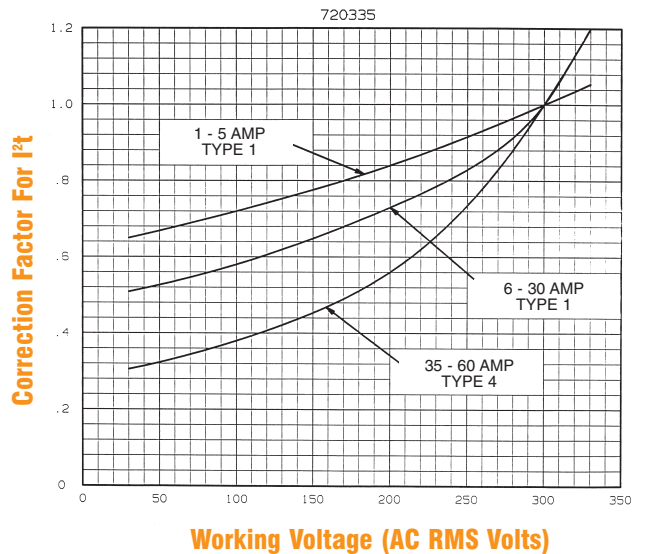

A30QS

SEMICONDUCTOR PROTECTION FUSES

Watts Loss at Rated Current

AMPERE RATING	WATTS LOSS (W)		AMPERE RATING	WATTS LOSS (W)	
	Type 1	Type 4		Type 4	Type 128
1	0.9		175	27	
2	1.0		200	30	
3	1.4		225	33	
4	1.7		250	41	
5	2.0		275	44	
6	2.3		300	47	
7	2.6		350	49	
8	3.0		400	56	
10	4.0		450	53	
12	4.9		500	59	
15	6.4		550	65	
20	8.8		600	69	
25	10.5		700	90	73
30	12.4		800	108	84
35		6.4	900		94
40		7.0	1000		105
45		9.0	1200		110
50		9.9	1500		140
60		11.6	1600		150
70		11	1800		170
80		11	2000		190
90		13	2500		230
100		13	3000		340
125		16	3500		380
130		16	4000		450
150		19	4500		500

Clearing I²t at 300VDC, 100kA, L/R = 10ms

AMPERE RATING	CLEARING I ² t (A ² s X 10 ³)	AMPERE RATING	CLEARING I ² t (A ² s X 10 ³)
35	0.45	450	100
40	0.58	500	130
50	0.96	550	150
60	1.3	600	190
70	1.3	700	200
80	2.1	800	260
90	2.5	900	300
100	3.3	1000	360
125	5.0	1200	710
130	5.0	1500	1200
150	7.5	1600	1400
175	8.3	1800	1600
200	12	2000	2100
225	18	2500	3300
250	20	3000	4300
275	25	3500	5900
300	29	4000	7700
350	50	4500	9900
400	66		

Watts loss vs. Percent Rated Current

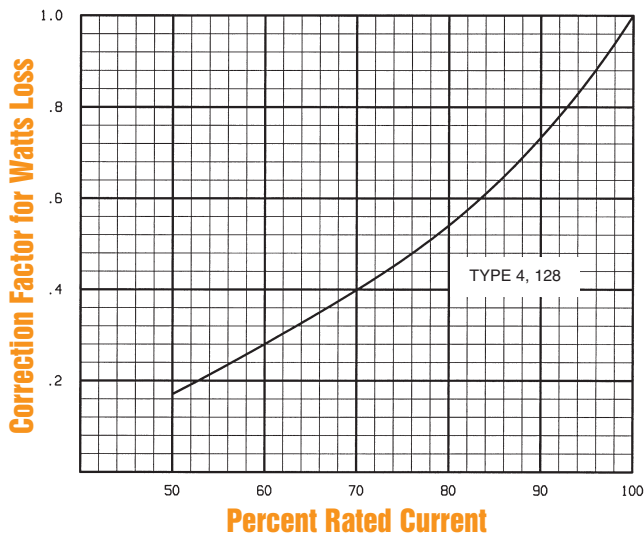

DC Voltage Capability vs. Circuit Time Constant (ms)

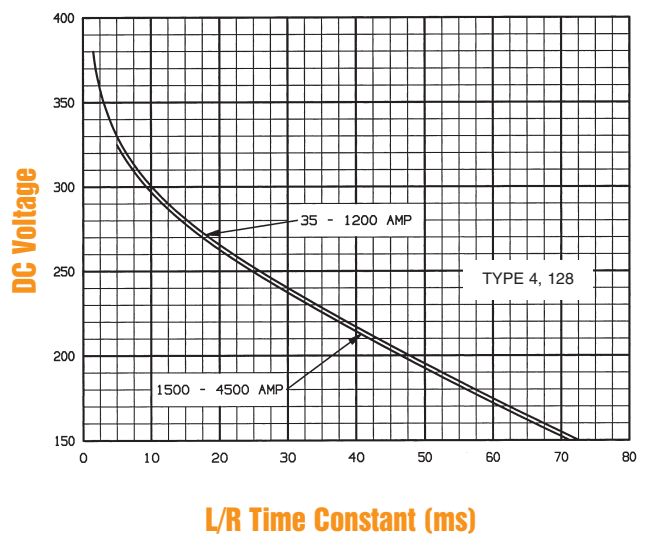

A30QS

SEMICONDUCTOR PROTECTION FUSES

Melting Time - Current Data A30QS 1 to 60

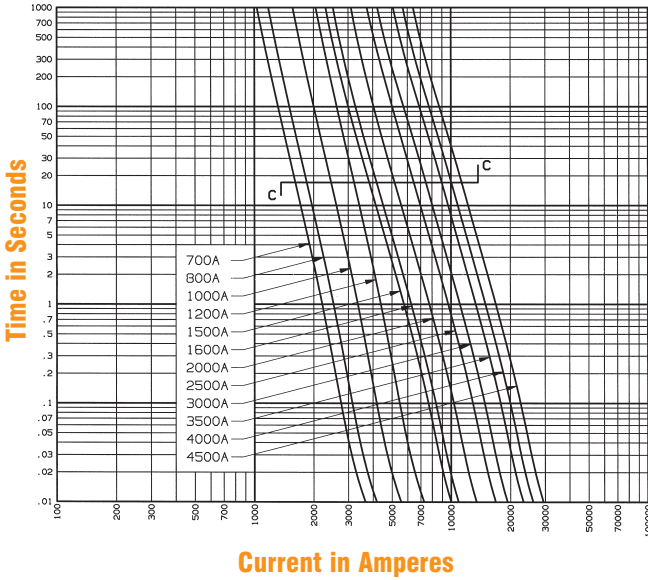

Melting Time - Current Data A30QS 70 to 800

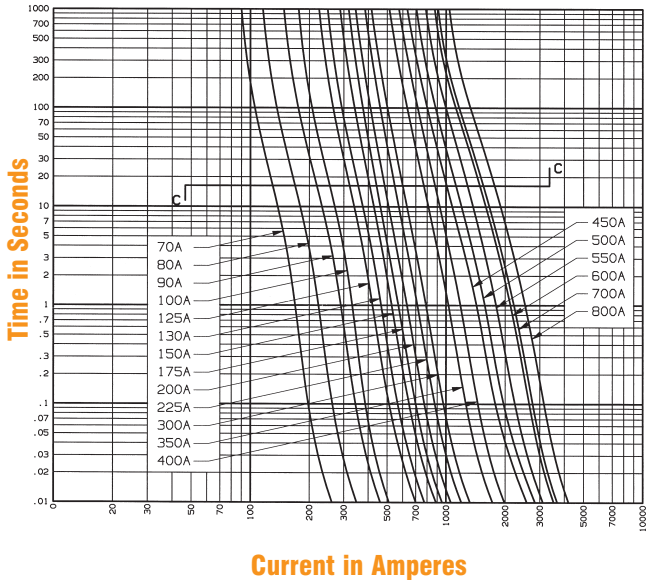

D

Melting Time - Current Data A30QS 700 to 4500

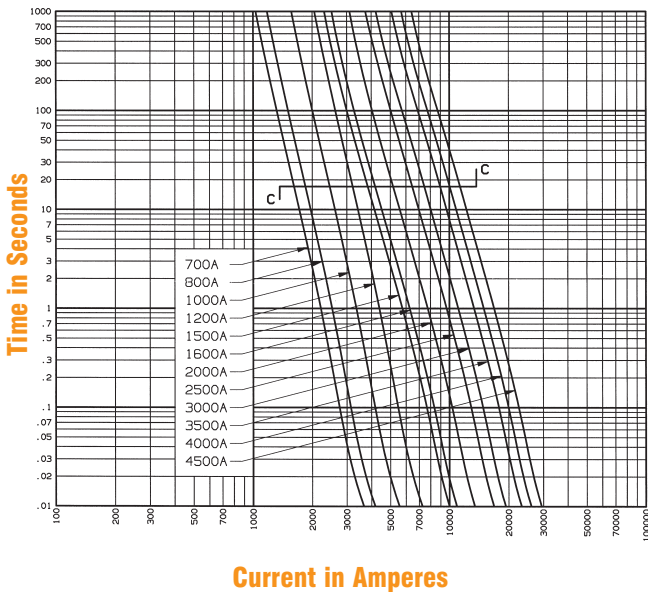

Peak Let Thru Data

