

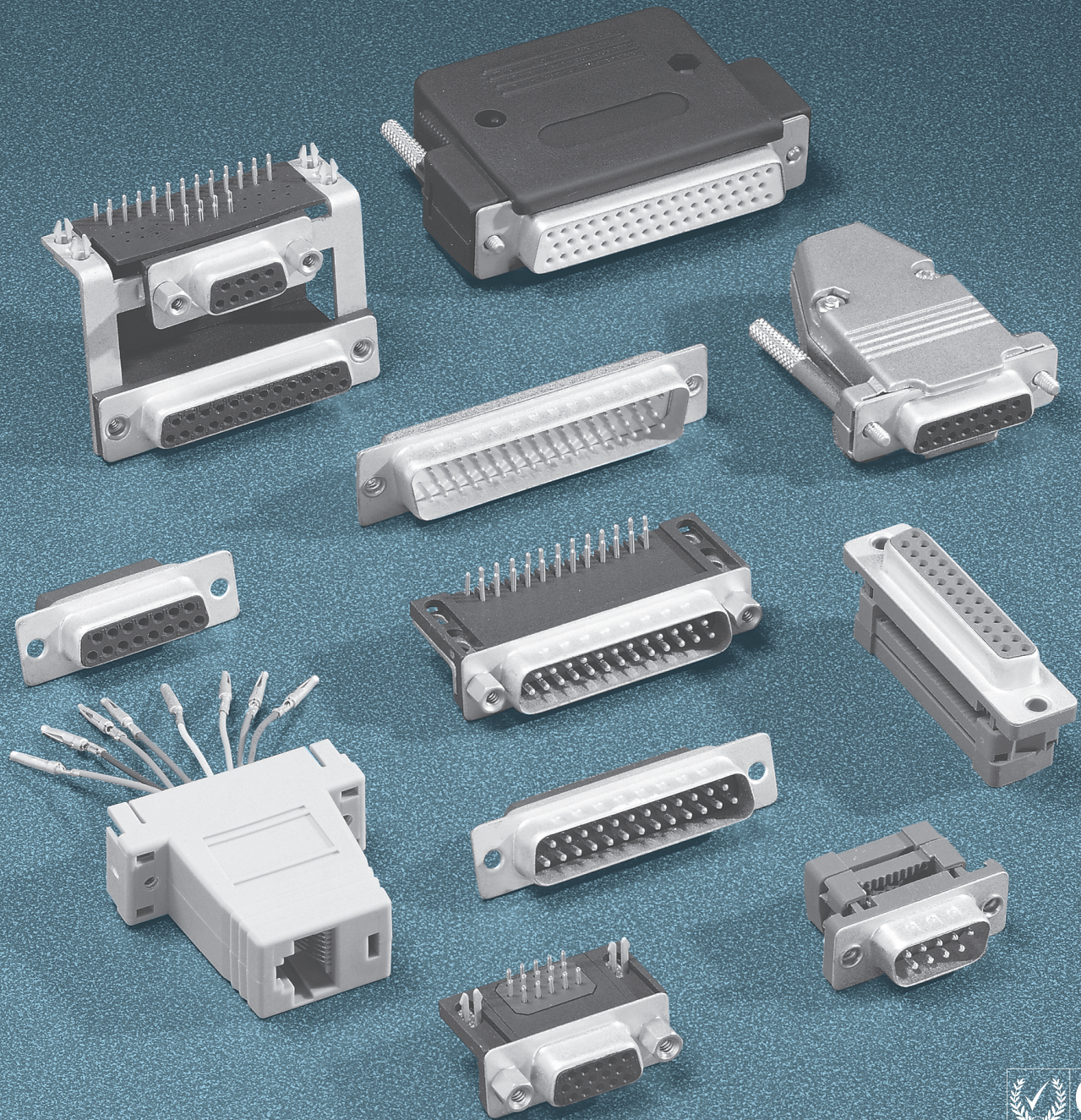

D-SUB CONNECTORS



Power Dynamics filtered and unfiltered D-Sub miniature connectors are low-cost, space-saving components used in a wide variety of applications. They are available in standard 9, 15, 25, 37 pins, high density 15, 26, 44, 62, pins, and stackable versions. Termination types include P.C.B., solder cup, and I.D.C. Power Dynamics filtered D-Subs have integrated ferrite plates. All PDI D-Subs carry the  and  safety approvals.



PDI[®]
Power Dynamics, Inc.

EXAMPLE & ORDERING CODE

RIGHT ANGLE, P.C.B. PDI - 15 - S - 9 - J - [] - []

NUMBER OF PINS:
 = 09
 = 15
 = 25
 = 37

GENDER:
 MALE = S
 FEMALE = R

FOOT PRINT LENGTH:
 7.2mm = BLANK
 5.34mm = 5
 9.4mm = 9
 13.84mm = 13
 9.4mm RECESSED BOARD LOCK = 9L
 13.84mm RECESSED BOARD LOCK = 13L

MATING FACE:
 4-40 THREADED RIVET = BLANK
 JACK SCREW 4-40 THREAD = J
 RIVETED HEX STANDOFF = K
 4-40 THREADED RIVET AND JACK SCREW (UNASSEMBLED) = P
 4-40 THREADED RIVET AND JACK SCREW = R

P.C.B. FACE:
 BOARD LOCK = BLANK
 HOLE = H
 THREADED HOLE = T
 NO GROUNDING STRAP = Z

GOLD PLATING:
 (XX is gold in micro inches) = GXX
 GOLD FLASH (STANDARD) = BLANK

SPECIFICATIONS

MATERIAL AND FINISH:

Shell:
 Material: Steel
 Plating: Tin
 Thickness: Base Copper: 40µ"
 Tin: 80~120µ"

Contacts:
 Material: Brass (male)
 Phosphor Bronze (female)
 Plating: Gold Plate or Tin over Nickel
 Thickness: Gold Flash
 40µ" Nickel base
 80~100µ" Tin

Insulator:
 P.B.T. and glass-fiber reinforced
 UL 94V-0

Mechanical:
 Mating Force: **9 PIN 15 PIN 25 PIN 37 PIN**
 minimum: 1.5 kg 2.0 kg 3.0 kg 3.0 kg
 maximum: 5.0 kg 7.0 kg 8.0 kg 12.0 kg

Unmating Force: **9 PIN 15 PIN 25 PIN 37 PIN**
 minimum: 1.5 kg 2.0 kg 3.5 kg 3.5 kg
 maximum: 5.0 kg 7.0 kg 8.0 kg 12.0 kg

ELECTRICAL SPECIFICATIONS:

Rated Current: 3A
Rated Voltage: 300 VDC
Insulator Resistance:
 3000 Megaohm min. @ 500 VDC
Contact Resistance: 15 milliohm max.
Dielectric Withstanding Strength:
 1000 VA for 1 minute
Temperature: -55°C to 105°C



145 Algonquin Parkway, Whippany, NJ 07981 • 973-560-0019 • FAX: 973-560-0076
 e-mail: sales@powerdynamics.com • www.powerdynamics.com

Board Mount Options, Right Angle

P.C.B. FACE OPTIONS

MATING FACE OPTIONS

	BOARD LOCK	HOLE	THREADED HOLE
JACK SCREW 4-40 THREAD			
4-40 THREADED RIVET AND JACK SCREW			
4-40 THREADED RIVET			
RIVETED HEX STANDOFF			

7

D-SUB CONNECTORS

Right Angle, P.C.B., 5.0mm Footprint

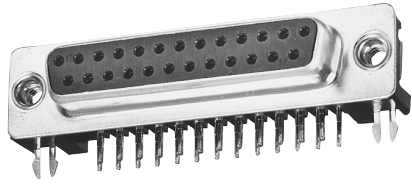

PDI-25R-5

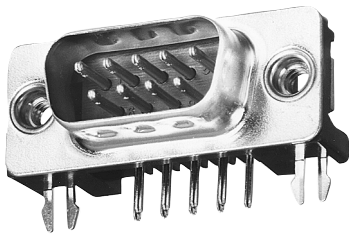
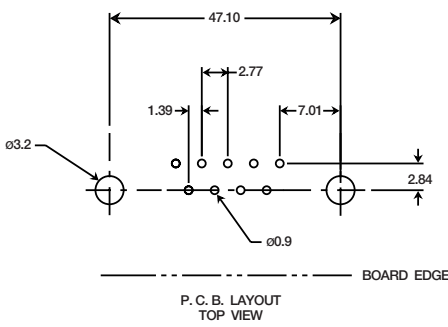
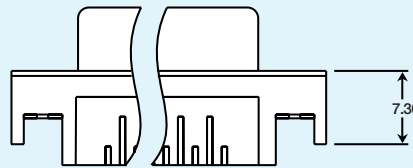
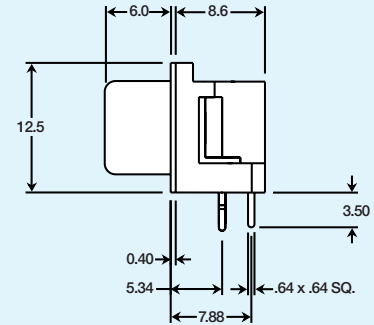
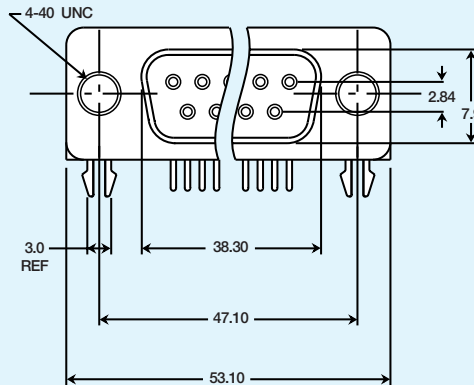

PDI-09S-5

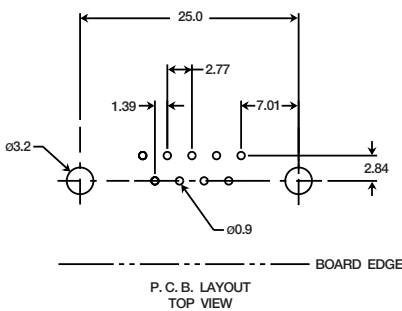
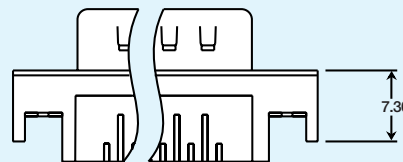
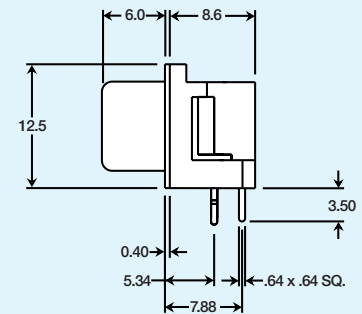
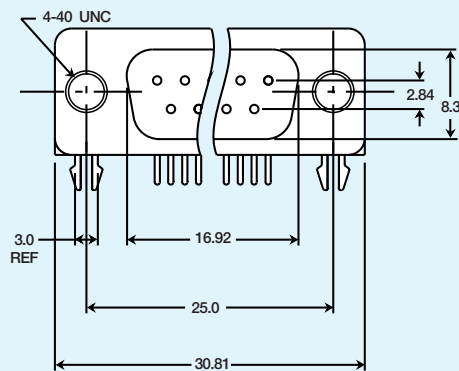

Specifications subject to change without notice. Dimensions in mm.

7

D-SUB CONNECTORS



145 Algonquin Parkway, Whippany, NJ 07981 • 973-560-0019 • FAX: 973-560-0076
e-mail: sales@powerdynamics.com • www.powerdynamics.com

Right Angle, P.C.B., 7.2mm Footprint

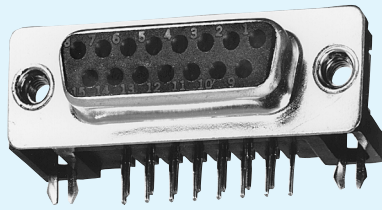

PDI-15R
(shown)

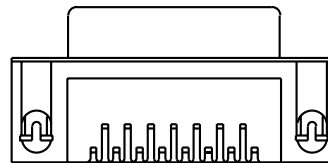
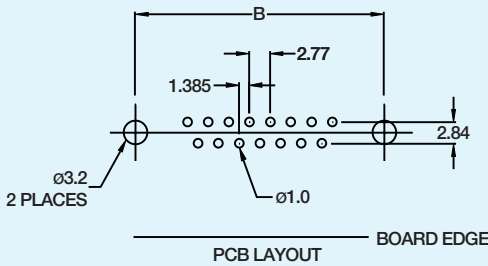
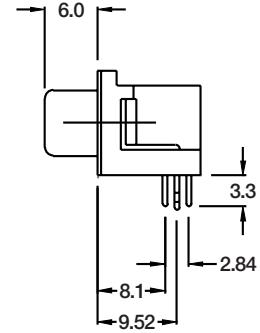
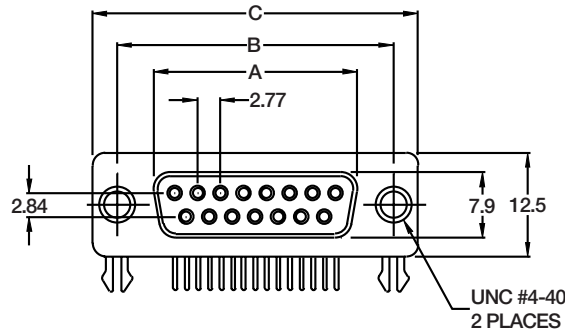

	NUMBER OF PINS			
	9	15	25	37
A	16.30	24.60	38.30	54.80
B	25.00	33.30	47.10	63.50
C	30.80	39.20	53.10	69.40

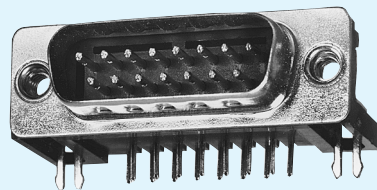

PDI-15S
(shown)

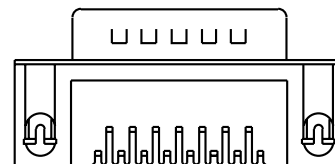
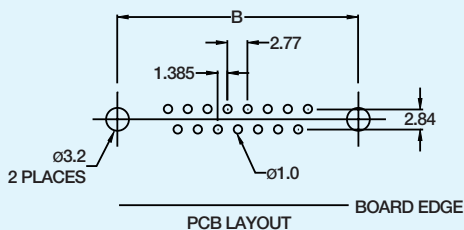
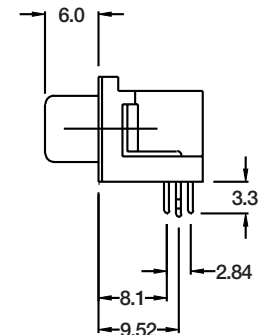
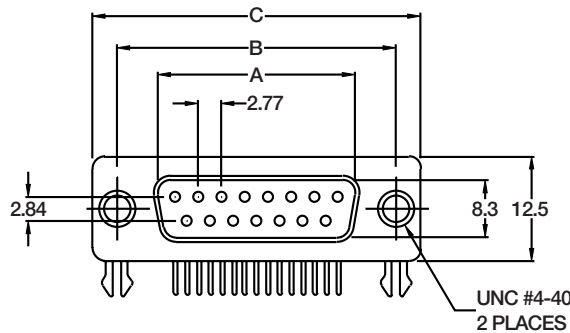

	NUMBER OF PINS			
	9	15	25	37
A	16.92	25.25	38.96	55.42
B	25.00	33.30	47.10	63.50
C	30.80	39.20	53.10	69.40

Specifications subject to change without notice. Dimensions in mm.

Right Angle, P.C.B., 9.4mm Footprint

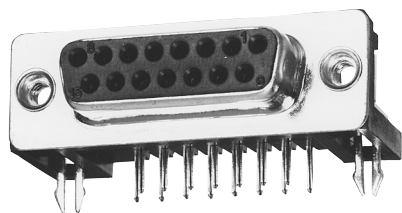

PDI-15R-9
(shown)

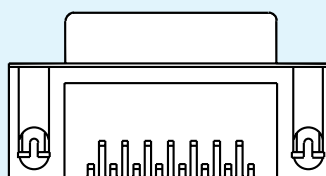
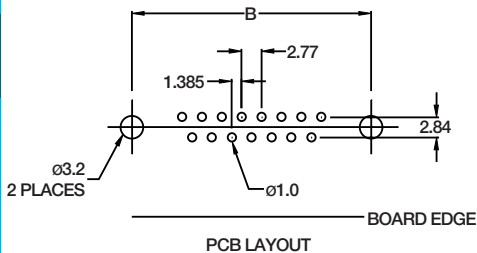
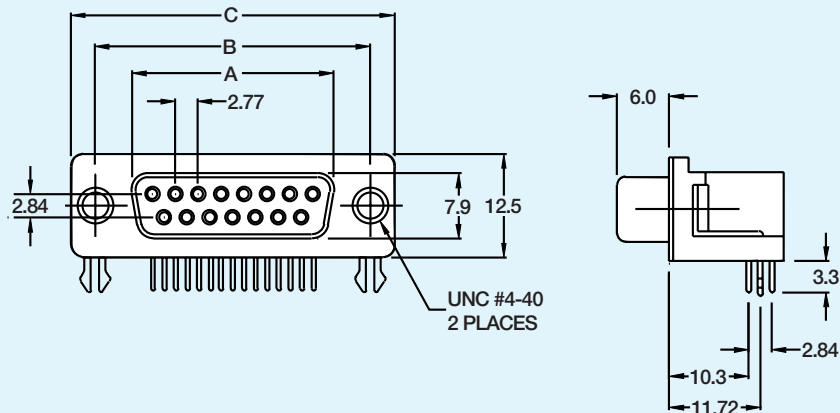

NUMBER OF PINS				
	9	15	25	37
A	16.30	24.60	38.30	54.80
B	25.00	33.30	47.10	63.50
C	30.80	39.20	53.10	69.40

7

D-SUB CONNECTORS

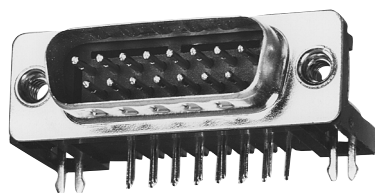

PDI-15S-9
(shown)

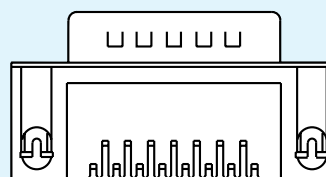
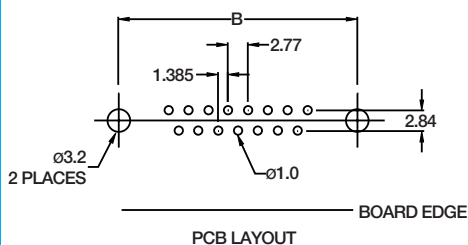
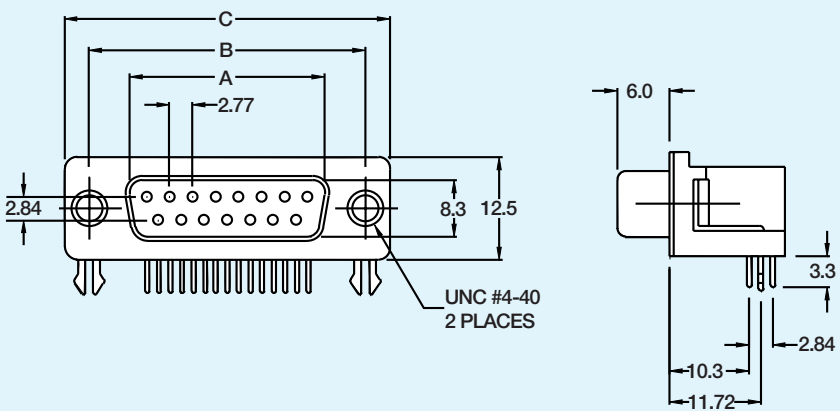

NUMBER OF PINS				
	9	15	25	37
A	16.92	25.25	38.96	55.42
B	25.00	33.30	47.10	63.50
C	30.80	39.20	53.10	69.40

Specifications subject to change without notice. Dimensions in mm.



145 Algonquin Parkway, Whippany, NJ 07981 • 973-560-0019 • FAX: 973-560-0076
e-mail: sales@powerdynamics.com • www.powerdynamics.com

EXAMPLE & ORDERING CODE

HIGH DENSITY,
RIGHT ANGLE, P.C.B.

PDI - **15** **S** H- - **J** **H**

NUMBER OF PINS:
= 15
= 26
= 44
= 62

GENDER:
MALE = S
FEMALE = R

FOOT PRINT LENGTH:
11.26mm = BLANK
5.34mm = 5

MATING FACE:
4-40 THREADED RIVET = BLANK
JACK SCREW 4-40 THREAD = J
RIVETED HEX STANDOFF = K
4-40 THREADED RIVET AND JACK SCREW (JACK SCREW UNASSEMBLED) = P
4-40 THREADED RIVET AND JACK SCREW = R

P.C.B. FACE:
BOARD LOCK = BLANK
HOLE = H
THREADED HOLE = T
NO GROUNDING STRAP = Z

GOLD PLATING: (XX is gold in micro inches) = GXX
GOLD FLASH (STANDARD) = BLANK

SPECIFICATIONS

MATERIAL AND FINISH:

Shell:

Material: Steel
Plating: Tin
Thickness: Base Copper: 40µ"
Tin: 80~120µ"

Contacts:

Material: Brass (male)
Phosphor Bronze (female)
Plating: Gold Plate or Tin over Nickel
Thickness: Gold Flash
40µ" Nickel base
80~100µ" Tin

Insulator:

P.B.T. and glass-fiber reinforced
UL 94V-0

Mechanical:

Mating Force:	9 PIN	15 PIN	25 PIN	37 PIN
minimum:	1.5 kg	2.0 kg	3.0 kg	3.0 kg
maximum:	5.0 kg	7.0 kg	8.0 kg	12.0 kg
Unmating Force:	9 PIN	15 PIN	25 PIN	37 PIN
minimum:	1.5 kg	2.0 kg	3.5 kg	3.5 kg
maximum:	5.0 kg	7.0 kg	8.0 kg	12.0 kg

ELECTRICAL SPECIFICATIONS:

Rated Current: 3A
Rated Voltage: 300 VDC
Insulator Resistance:
3000 Megaohm min. @ 500 VDC
Contact Resistance: 15 milliohm max.
Dielectric Withstanding Strength:
1000 VA for 1 minute
Temperature: -55°C to 105°C



145 Algonquin Parkway, Whippany, NJ 07981 • 973-560-0019 • FAX: 973-560-0076
e-mail: sales@powerdynamics.com • www.powerdynamics.com

High Density, Right Angle, P.C.B., 5.0mm Footprint

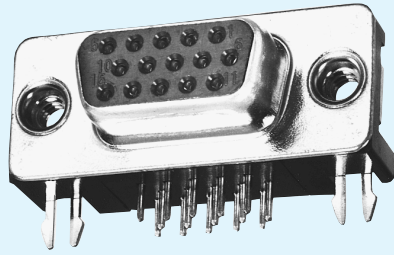

PDI-15RH-5

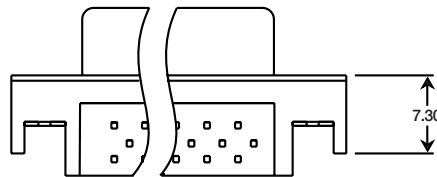
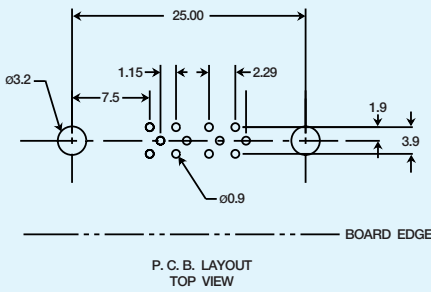
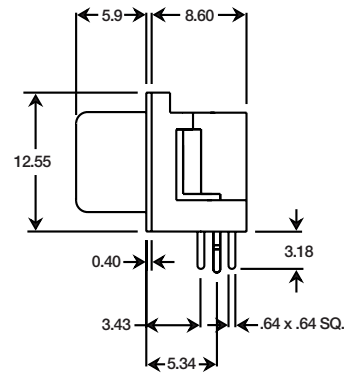
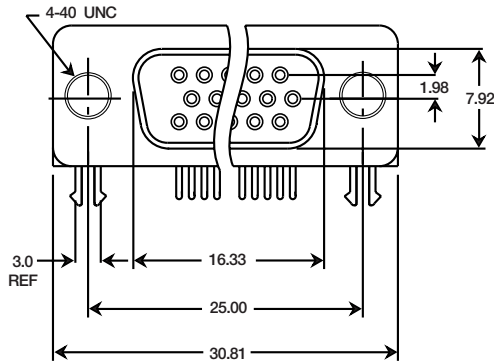

Specifications subject to change without notice. Dimensions in mm.

145 Algonquin Parkway, Whippany, NJ 07981 • 973-560-0019 • FAX: 973-560-0076
e-mail: sales@powerdynamics.com • www.powerdynamics.com



High Density, Right Angle, P.C.B.

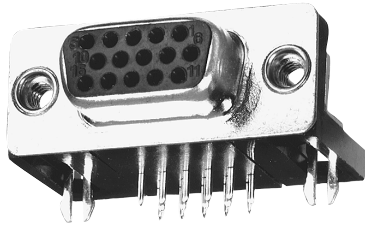

PDI-15RH
(shown)

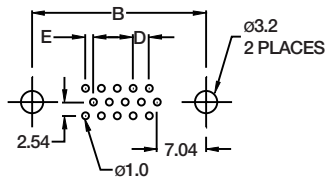

P.C. BOARD EDGE
15 POSITION FEMALE

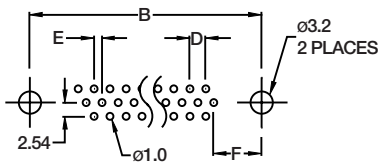

P.C. BOARD EDGE
26, 44, 62 POSITION FEMALE

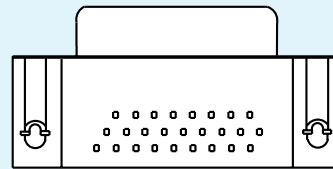
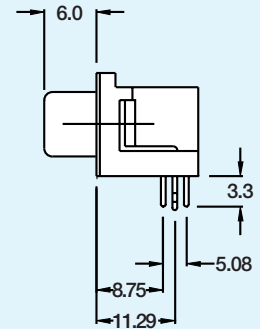
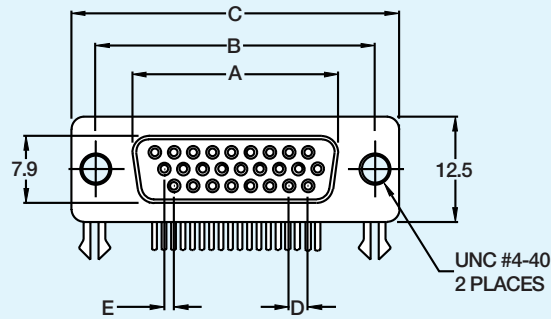

NUMBER OF PINS				
	15	26	44	62
A	16.30	24.60	38.30	54.80
B	25.00	33.30	47.10	63.50
C	30.80	39.20	53.10	69.40
D	2.29	2.29	2.29	2.41
E	1.145	1.145	1.145	1.205
F	7.04	6.88	6.88	7.00

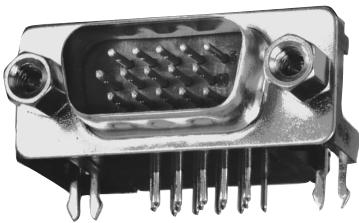

PDI-15SH-J
(shown)

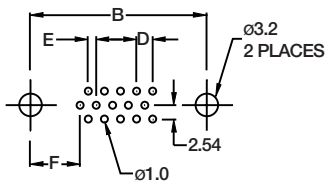

P.C. BOARD EDGE
15 POSITION MALE

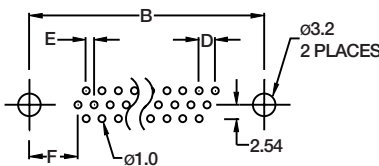

P.C. BOARD EDGE
26, 44, 62 POSITION MALE

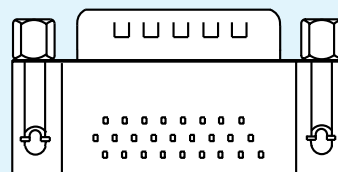
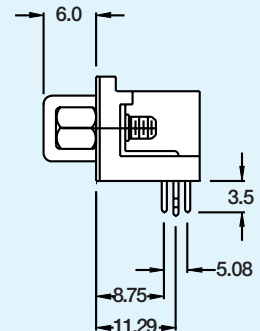
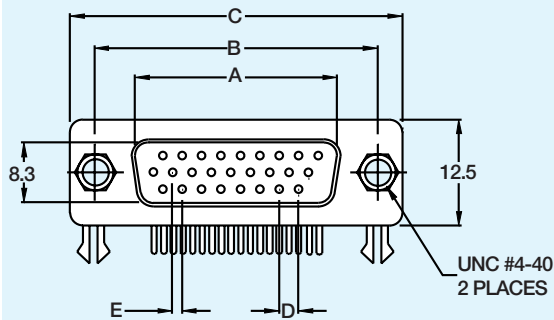

NUMBER OF PINS				
	15	26	44	62
A	16.92	25.25	38.96	55.42
B	25.00	33.30	47.10	63.50
C	30.80	39.20	53.10	69.40
D	2.29	2.29	2.29	2.41
E	1.145	1.145	1.145	1.205
F	7.04	6.88	6.88	7.00

Specifications subject to change without notice. Dimensions in mm.



145 Algonquin Parkway, Whippany, NJ 07981 • 973-560-0019 • FAX: 973-560-0076
e-mail: sales@powerdynamics.com • www.powerdynamics.com

EXAMPLE & ORDERING CODE

STACKED PDI - **B** **A** - **H**

NUMBER OF PINS:	
9 PIN TOP / 9 PIN BOTTOM	= A
9 PIN TOP / 25 PIN BOTTOM	= B
25 PIN TOP / 9 PIN BOTTOM	= C
25 PIN TOP / 25 PIN BOTTOM	= D
15 PIN TOP / 15 PIN BOTTOM	= E
9 PIN TOP / 15HD PIN BOTTOM	= F

GENDER:	
MALE TOP / MALE BOTTOM	= A
MALE TOP / FEMALE BOTTOM	= B
FEMALE TOP / MALE BOTTOM	= C
FEMALE TOP / FEMALE BOTTOM	= D

D-SUB SPACING (CENTER TO CENTER):	
15.88mm	= BLANK
19.05mm	= A
22.86mm	= B

MATING FACE:	
4-40 THREADED RIVET	= BLANK
4-40 THREADED RIVET AND JACK SCREW (JACK SCREW UNASSEMBLED)	= P
4-40 THREADED RIVET AND JACK SCREW	= R

P.C.B. FACE:	
ONE SET OF BOARD LOCKS	= BLANK
HOLE	= H
THREADED HOLE	= T
TWO SETS OF BOARD LOCKS	= V

GOLD PLATING: (XX is gold in micro inches)	= GXX
GOLD FLASH (STANDARD)	= BLANK

7

D-SUB CONNECTORS

SPECIFICATIONS

MATERIAL AND FINISH:

Shell:
 Material: Steel
 Plating: Tin
 Thickness: Base Copper: 40µ"
 Tin: 80~120µ"

Contacts:
 Material: Brass (male)
 Phosphor Bronze (female)
 Plating: Gold Plate or Tin
 Thickness: Gold Flash
 40µ" Nickel base
 80~100µ" Tin

Insulator:

P.B.T. and glass-fiber reinforced
 UL 94V-0

Mechanical:

Mating Force:	9 PIN	15 PIN	25 PIN	37 PIN
minimum:	1.5 kg	2.0 kg	3.0 kg	3.0 kg
maximum:	5.0 kg	7.0 kg	8.0 kg	12.0 kg
Unmating Force:	9 PIN	15 PIN	25 PIN	37 PIN
minimum:	1.5 kg	2.0 kg	3.5 kg	3.5 kg
maximum:	5.0 kg	7.0 kg	8.0 kg	12.0 kg

ELECTRICAL SPECIFICATIONS:

Rated Current: 3A
Rated Voltage: 300 VDC
Insulator Resistance:
 3000 Megaohm min. @ 500 VDC
Contact Resistance: 15 milliohm max.
Dielectric Withstanding Strength:
 1000 VA for 1 minute
Temperature: -55°C to 105°C



Stacked

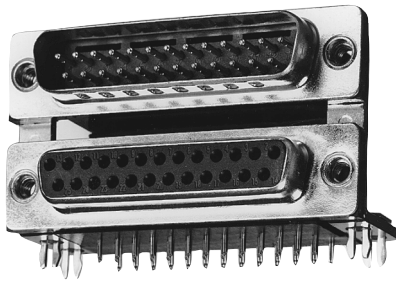

PDI-DB-V
(shown)

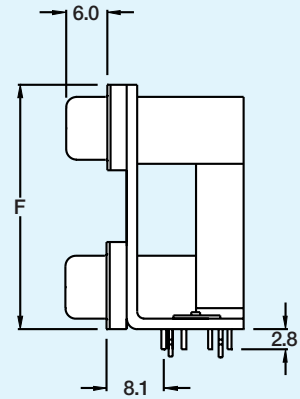
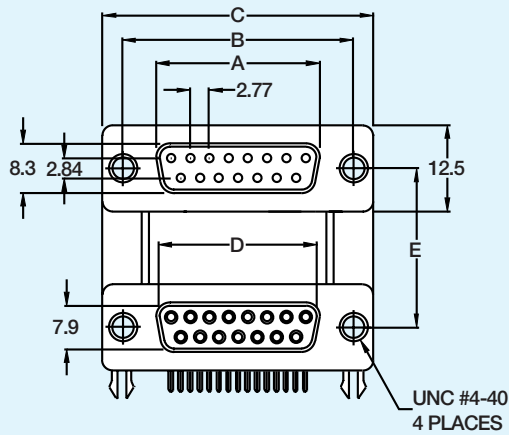

NUMBER OF PINS				
	9	15	25	37
A	16.92	25.25	38.96	55.42
B	25.00	33.30	47.10	63.50
C	30.80	39.20	53.10	69.40
D	16.30	24.60	38.30	54.80

PORT TO PORT SPACING			
	E	F	
E	15.88	19.05	22.86
F	28.38	31.55	35.36

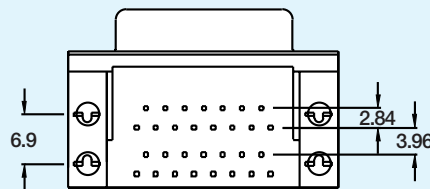
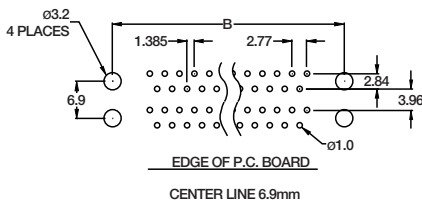

7

D-SUB CONNECTORS

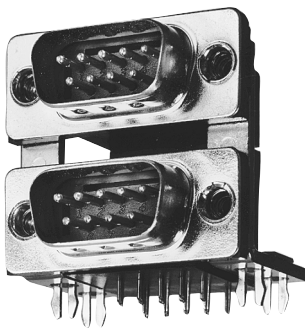

PDI-AA-V
(shown)

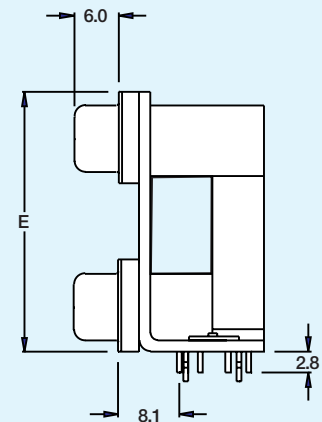
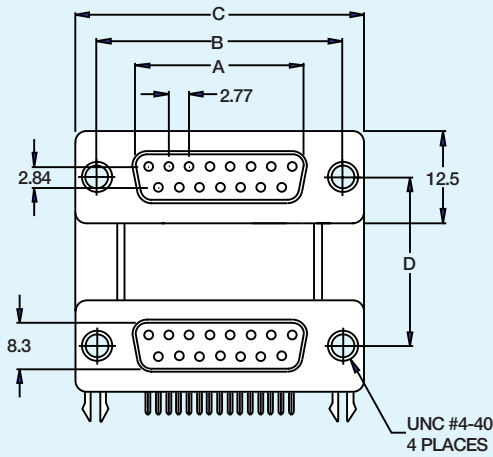

NUMBER OF PINS				
	9	15	25	37
A	16.92	25.25	38.96	55.42
B	25.00	33.30	47.10	63.50
C	30.80	39.20	53.10	69.40

PORT TO PORT SPACING			
	D	E	
D	15.88	19.05	22.86
E	28.38	31.55	35.36

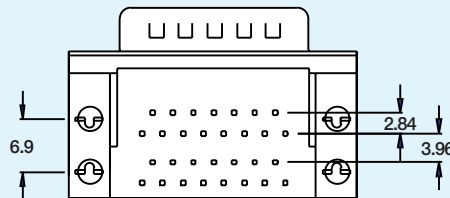
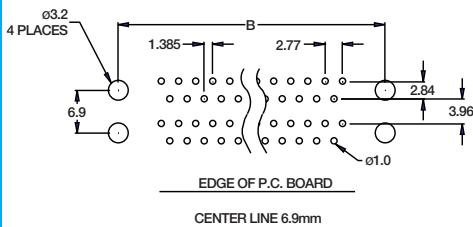

Specifications subject to change without notice. Dimensions in mm.



145 Algonquin Parkway, Whippany, NJ 07981 • 973-560-0019 • FAX: 973-560-0076
e-mail: sales@powerdynamics.com • www.powerdynamics.com

Stacked

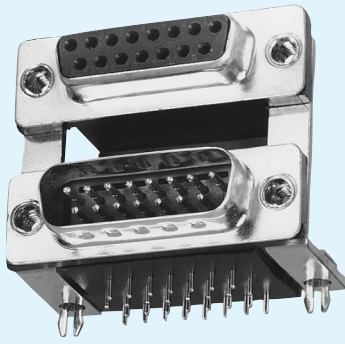

PDI-ECA
(shown)

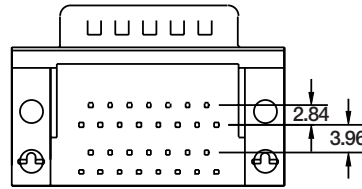
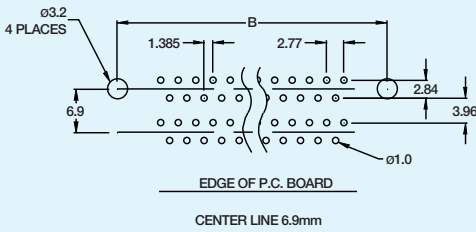
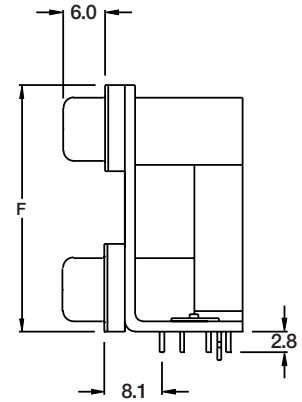
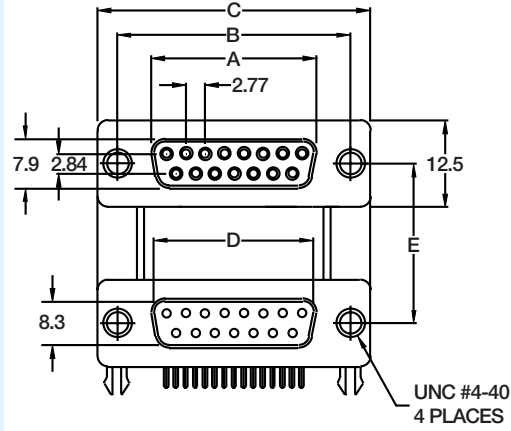

NUMBER OF PINS				
	9	15	25	37
A	16.30	24.60	38.30	54.80
B	25.00	33.30	47.10	63.50
C	30.80	39.20	53.10	69.40
D	16.92	25.25	38.96	55.42

PORT TO PORT SPACING			
E	15.88	19.05	22.86
F	28.38	31.55	35.36

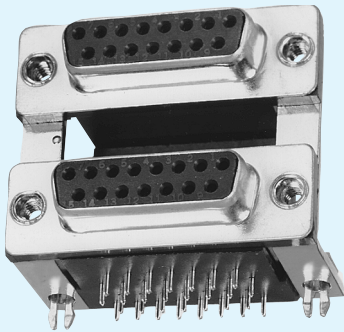

PDI-EDA
(shown)

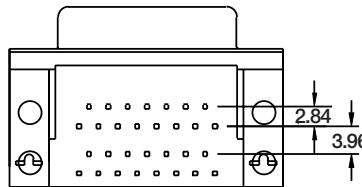
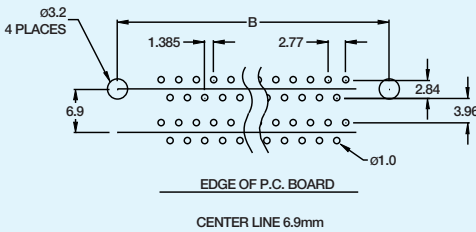
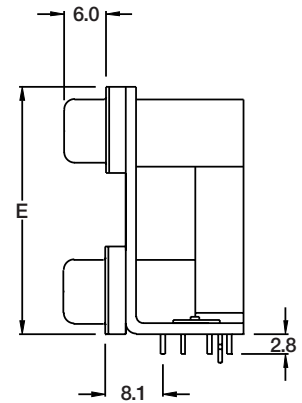
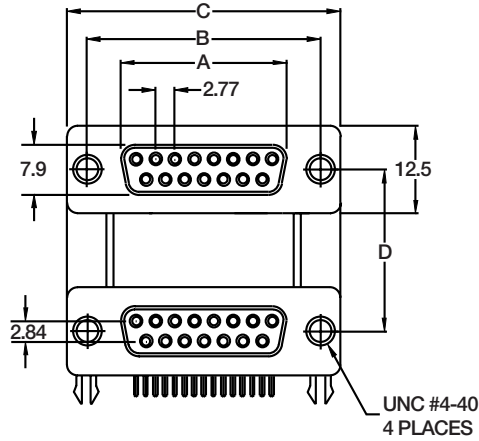

NUMBER OF PINS				
	9	15	25	37
A	16.30	24.60	38.30	54.80
B	25.00	33.30	47.10	63.50
C	30.80	39.20	53.10	69.40

PORT TO PORT SPACING			
D	15.88	19.05	22.86
E	28.38	31.55	35.36

Specifications subject to change without notice. Dimensions in mm.

145 Algonquin Parkway, Whippany, NJ 07981 • 973-560-0019 • FAX: 973-560-0076
e-mail: sales@powerdynamics.com • www.powerdynamics.com



7

D-SUB CONNECTORS

EXAMPLE & ORDERING CODE

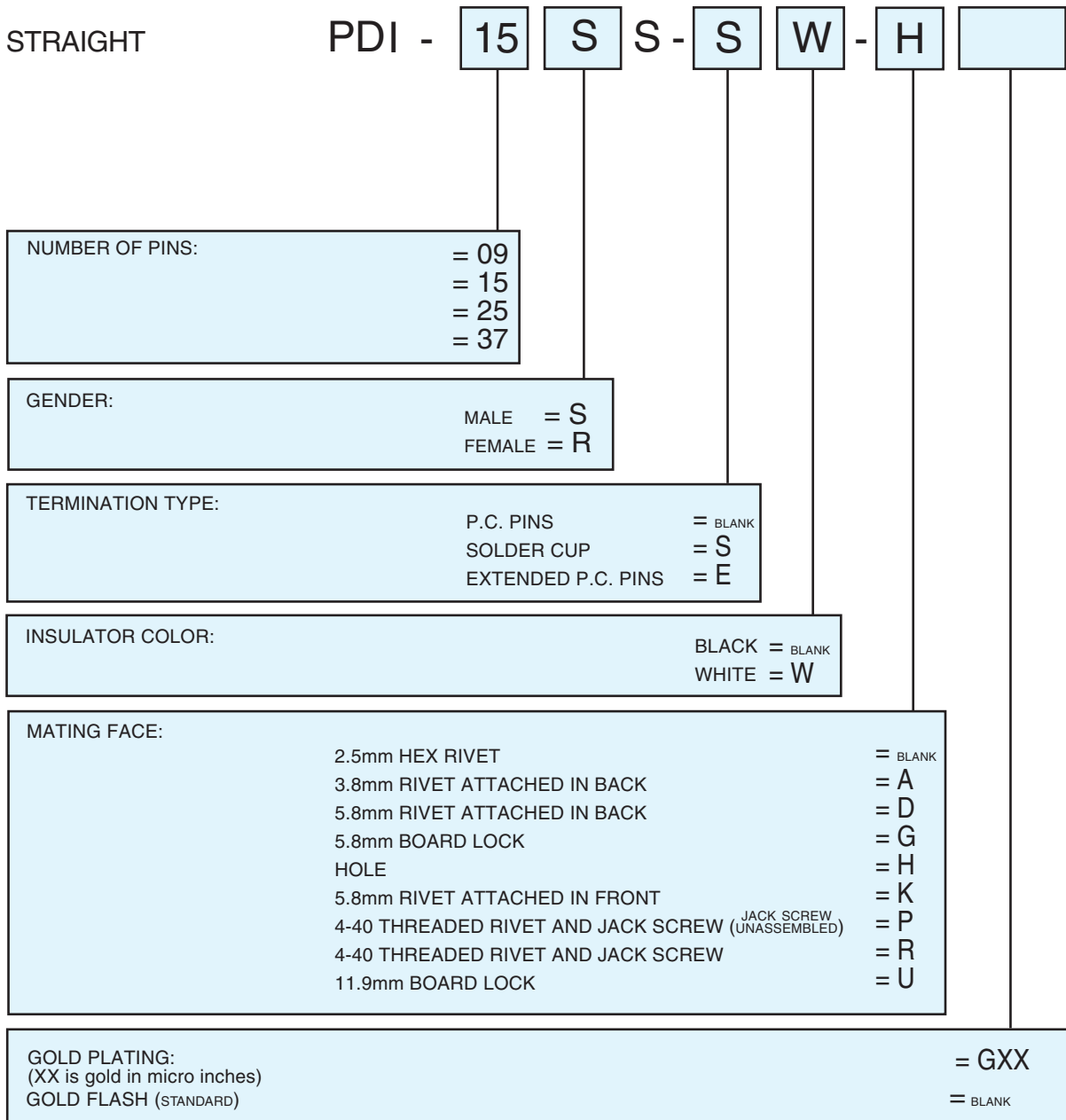

SPECIFICATIONS

MATERIAL AND FINISH:

Shell:
Material: Steel
Plating: Tin or Nickel
Thickness: Base Copper: 40µ"
Tin: 80-120µ"

Contacts:
Material: Brass (male)
Phosphor Bronze (female)
Plating: Gold Plate or Tin
Thickness: Gold Flash
40µ" Nickel base
80-100µ" Tin

Insulator:

P.B.T. and glass-fiber reinforced
UL 94V-0

Mechanical:

Mating Force: **9 PIN** 1.5 kg 2.0 kg 3.0 kg 3.0 kg
 15 PIN 2.0 kg 7.0 kg 8.0 kg 12.0 kg
 25 PIN 3.0 kg 8.0 kg 8.0 kg 12.0 kg
 37 PIN 3.0 kg 12.0 kg 12.0 kg 12.0 kg

Unmating Force: **9 PIN** 1.5 kg 2.0 kg 3.5 kg 3.5 kg
 15 PIN 2.0 kg 7.0 kg 8.0 kg 12.0 kg
 25 PIN 3.5 kg 8.0 kg 8.0 kg 12.0 kg
 37 PIN 3.5 kg 12.0 kg 12.0 kg 12.0 kg

ELECTRICAL SPECIFICATIONS:

Rated Current: 3A
Rated Voltage: 300 VDC
Insulator Resistance:
3000 Megaohm min. @ 500 VDC
Contact Resistance: 15 milliohm max.
Dielectric Withstanding Strength:
1000 VAC for 1 minute
Temperature: -55°C to 105°C



145 Algonquin Parkway, Whippany, NJ 07981 • 973-560-0019 • FAX: 973-560-0076
e-mail: sales@powerdynamics.com • www.powerdynamics.com

Board Mount Options, Straight

TERMINATION TYPE

MATING FACE OPTIONS

	P.C. PINS	SOLDER CUP	EXTENDED P.C. PINS
HOLE			
5.8mm RIVET ATTACHED IN FRONT			
2.5mm HEX RIVET			
5.8mm RIVET ATTACHED IN BACK			
5.8mm BOARD LOCK			
11.9mm BOARD LOCK			

7

D-SUB CONNECTORS

Straight, P.C. Pins

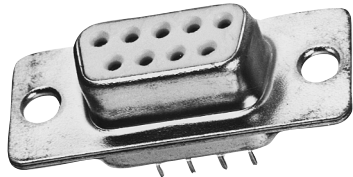

PDI-09RS-W-H
(shown)

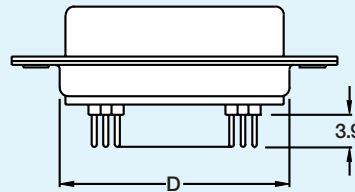
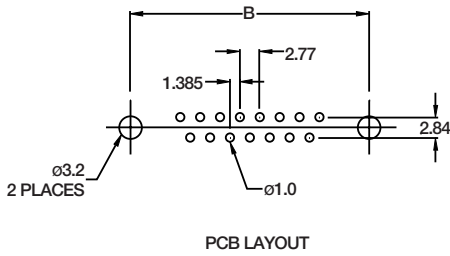
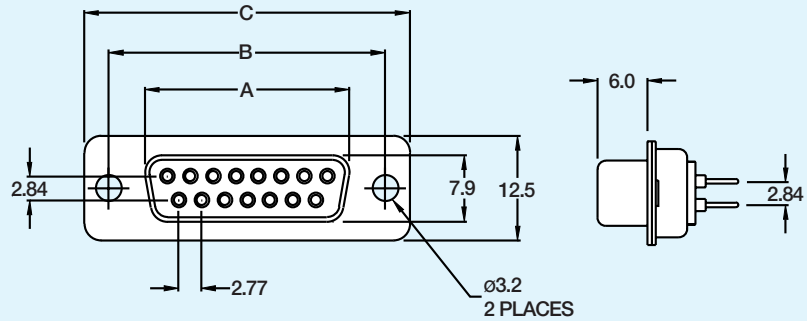

	NUMBER OF PINS			
	9	15	25	37
A	16.30	24.60	38.30	54.80
B	25.00	33.30	47.10	63.50
C	30.80	39.20	53.10	69.40
D	19.20	27.70	41.10	57.30

7

D-SUB CONNECTORS

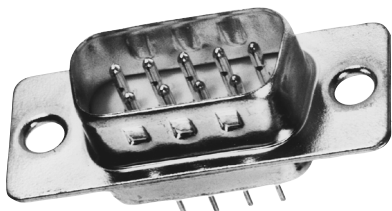

PDI-09SS-W-H
(shown)

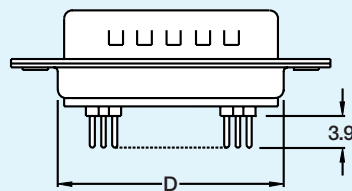
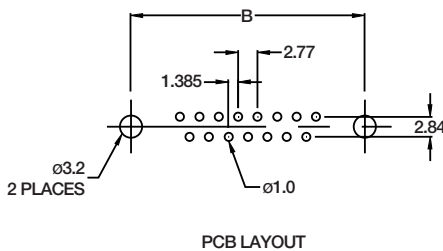
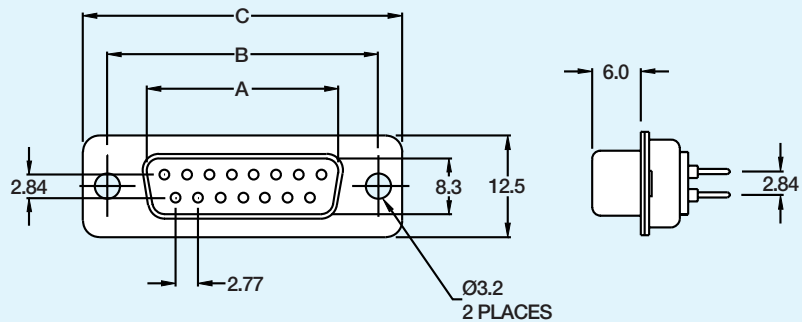

	NUMBER OF PINS			
	9	15	25	37
A	16.92	25.25	38.96	55.42
B	25.00	33.30	47.10	63.50
C	30.80	39.20	53.10	69.40
D	19.20	27.70	41.10	57.30

Specifications subject to change without notice. Dimensions in mm.



145 Algonquin Parkway, Whippany, NJ 07981 • 973-560-0019 • FAX: 973-560-0076
e-mail: sales@powerdynamics.com • www.powerdynamics.com

Straight, Solder Cup

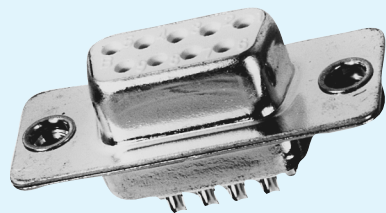

PDI-09RS-SW
(shown)

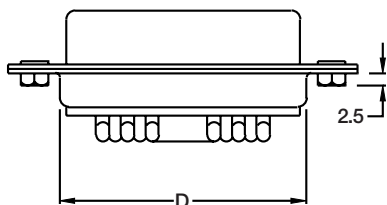
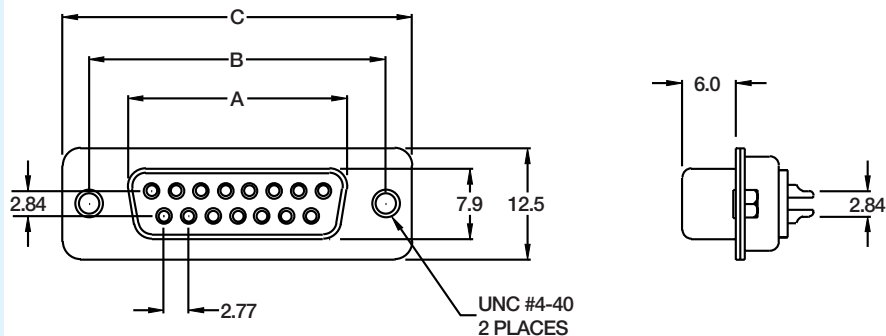

	NUMBER OF PINS			
	9	15	25	37
A	16.30	24.60	38.30	54.80
B	25.00	33.30	47.10	63.50
C	30.80	39.20	53.10	69.40
D	19.20	27.70	41.10	57.30

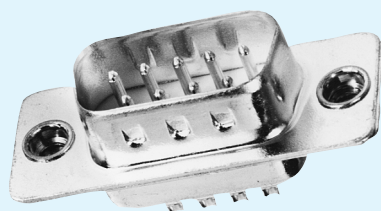

PDI-09SS-SW
(shown)

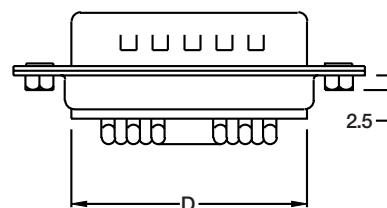
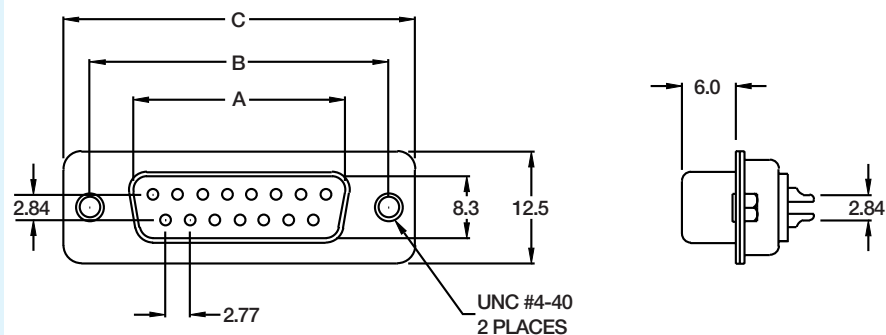

	NUMBER OF PINS			
	9	15	25	37
A	16.92	25.25	38.96	55.42
B	25.00	33.30	47.10	63.50
C	30.80	39.20	53.10	69.40
D	19.20	27.70	41.10	57.30

Specifications subject to change without notice. Dimensions in mm.

D-Sub Covers located on pages 210 and 211.

Custom molded cables also available. See page 290.

145 Algonquin Parkway, Whippany, NJ 07981 • 973-560-0019 • FAX: 973-560-0076
e-mail: sales@powerdynamics.com • www.powerdynamics.com



EXAMPLE & ORDERING CODE

HIGH DENSITY,
STRAIGHT

PDI - **15** **S** HS- **S** **W** - **H**

NUMBER OF PINS:	= 15 = 26 = 44 = 62																		
GENDER:	MALE = S FEMALE = R																		
TERMINATION TYPE:	P.C. PINS = BLANK SOLDER CUP = S EXTENDED P.C. PINS = E																		
INSULATOR COLOR:	BLACK = BLANK WHITE = W																		
MATING FACE:	<table style="width: 100%; border: none;"> <tr> <td style="width: 70%;">2.5mm HEX RIVET</td> <td style="text-align: right;">= BLANK</td> </tr> <tr> <td>3.8mm RIVET ATTACHED IN BACK</td> <td style="text-align: right;">= A</td> </tr> <tr> <td>5.8mm RIVET ATTACHED IN BACK</td> <td style="text-align: right;">= D</td> </tr> <tr> <td>5.8mm BOARD LOCK</td> <td style="text-align: right;">= G</td> </tr> <tr> <td>HOLE</td> <td style="text-align: right;">= H</td> </tr> <tr> <td>5.8mm RIVET ATTACHED IN FRONT</td> <td style="text-align: right;">= K</td> </tr> <tr> <td>4-40 THREADED RIVET AND JACK SCREW (JACK SCREW UNASSEMBLED)</td> <td style="text-align: right;">= P</td> </tr> <tr> <td>4-40 THREADED RIVET AND JACK SCREW</td> <td style="text-align: right;">= R</td> </tr> <tr> <td>11.9mm BOARD LOCK</td> <td style="text-align: right;">= U</td> </tr> </table>	2.5mm HEX RIVET	= BLANK	3.8mm RIVET ATTACHED IN BACK	= A	5.8mm RIVET ATTACHED IN BACK	= D	5.8mm BOARD LOCK	= G	HOLE	= H	5.8mm RIVET ATTACHED IN FRONT	= K	4-40 THREADED RIVET AND JACK SCREW (JACK SCREW UNASSEMBLED)	= P	4-40 THREADED RIVET AND JACK SCREW	= R	11.9mm BOARD LOCK	= U
2.5mm HEX RIVET	= BLANK																		
3.8mm RIVET ATTACHED IN BACK	= A																		
5.8mm RIVET ATTACHED IN BACK	= D																		
5.8mm BOARD LOCK	= G																		
HOLE	= H																		
5.8mm RIVET ATTACHED IN FRONT	= K																		
4-40 THREADED RIVET AND JACK SCREW (JACK SCREW UNASSEMBLED)	= P																		
4-40 THREADED RIVET AND JACK SCREW	= R																		
11.9mm BOARD LOCK	= U																		
GOLD PLATING: (XX is gold in micro inches)	= GXX																		
GOLD FLASH (STANDARD)	= BLANK																		

SPECIFICATIONS

MATERIAL AND FINISH:

Shell:
 Material: Steel
 Equivalent to ANSI 1008
 Plating: Tin
 Thickness: Base Copper: 40µ"
 Tin: 80-120µ"

Contacts:
 Material: Brass (male)
 Phosphor Bronze (female)
 Plating: Gold Plate or Tin,
 Gold Flash
 Thickness: 40µ" Nickel base
 80-100µ" Tin

Insulator:
 P.B.T. and glass-fiber reinforced
 UL 94V-0

Mechanical:
 Mating Force: **15 PIN 26 PIN 44 PIN 62 PIN**
 minimum: 1.5 kg 2.0 kg 3.5 kg 3.5 kg
 maximum: 5.0 kg 7.0 kg 8.0 kg 12.0 kg

Unmating Force: **15 PIN 26 PIN 44 PIN 62 PIN**
 minimum: 1.5 kg 2.0 kg 3.0 kg 3.0 kg
 maximum: 5.0 kg 7.0 kg 8.0 kg 12.0 kg

ELECTRICAL SPECIFICATIONS:

Rated Current: 3A
Rated Voltage: 300 VDC
Insulator Resistance:
 3000 Megaohm min. @ 500 VDC
Contact Resistance: 15 milliohm max.
Dielectric Withstanding Strength:
 1000 VAC for 1 minute
Temperature: -55°C to 105°C



145 Algonquin Parkway, Whippany, NJ 07981 • 973-560-0019 • FAX: 973-560-0076
 e-mail: sales@powerdynamics.com • www.powerdynamics.com

High Density, P.C. Pins

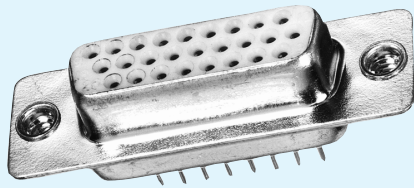

PDI-26RHS-W
(shown)

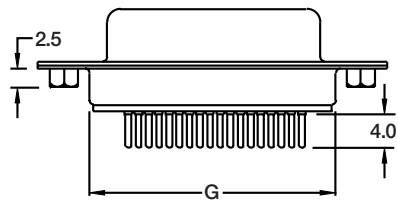
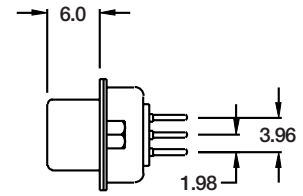
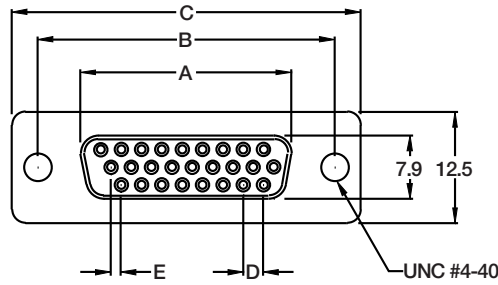
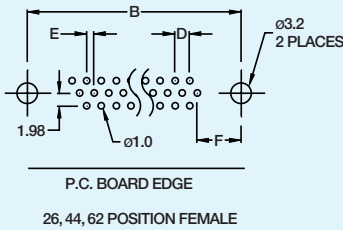
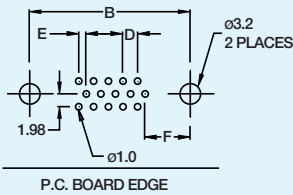

	NUMBER OF PINS			
	15	26	44	62
A	16.30	24.60	38.30	54.80
B	25.00	33.30	47.10	63.50
C	30.80	39.20	53.10	69.40
D	2.29	2.29	2.29	2.41
E	1.14	1.14	1.14	1.20
F	7.04	6.88	6.88	7.00
G	19.20	27.70	41.10	57.30

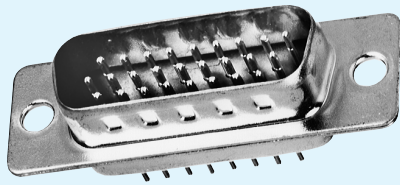

PDI-26SHS-H
(shown)

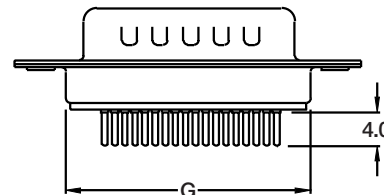
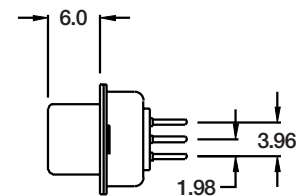
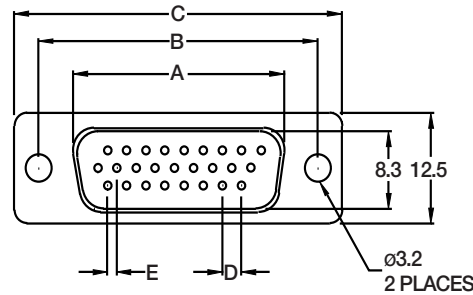
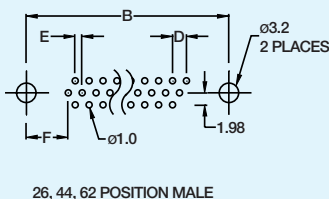
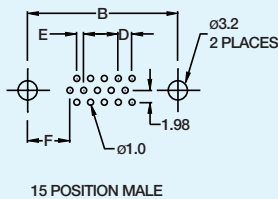

	NUMBER OF PINS			
	15	26	44	62
A	16.92	25.25	38.96	55.42
B	25.00	33.30	47.10	63.50
C	30.80	39.20	53.10	69.40
D	2.29	2.29	2.29	2.41
E	1.14	1.14	1.14	1.20
F	7.04	6.88	6.88	7.00
G	19.20	27.70	41.10	57.30

Specifications subject to change without notice. Dimensions in mm.

High Density, Solder Cup



PDI-26RHS-S-H
(shown)

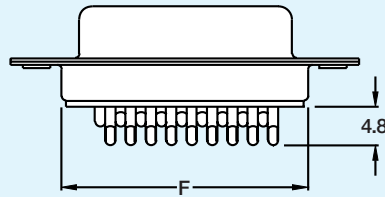
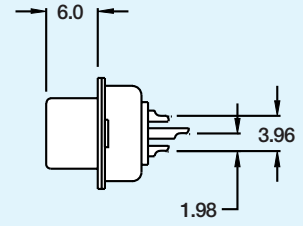
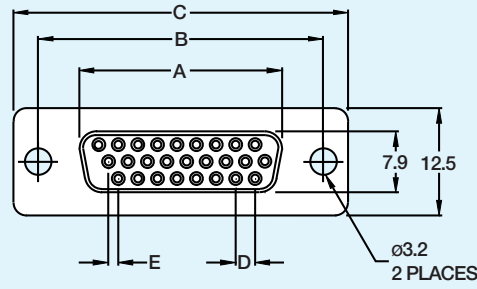

	NUMBER OF PINS			
	15	26	44	62
A	16.30	24.60	38.30	54.80
B	25.00	33.30	47.10	63.50
C	30.80	39.20	53.10	69.40
D	2.29	2.29	2.29	2.41
E	1.14	1.14	1.14	1.20
F	19.20	27.70	41.10	57.30

7

D-SUB CONNECTORS



PDI-26SHS-S-H
(shown)

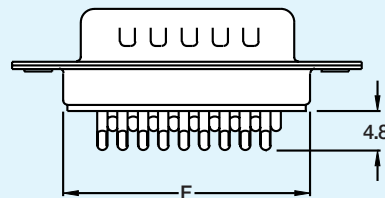
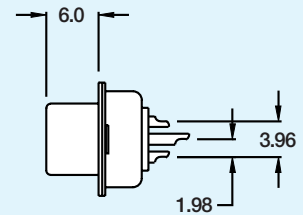
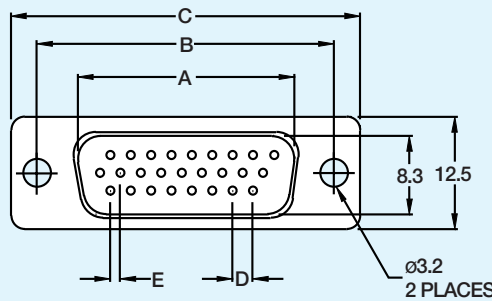

	NUMBER OF PINS			
	15	26	44	62
A	16.92	25.25	38.96	55.42
B	25.00	33.30	47.10	63.50
C	30.80	39.20	53.10	69.40
D	2.29	2.29	2.29	2.41
E	1.14	1.14	1.14	1.20
F	19.20	27.70	41.10	57.30

Specifications subject to change without notice. Dimensions in mm.

D-Sub Covers located on pages 210 and 211.

Custom molded cables also available. See page 290.



145 Algonquin Parkway, Whippany, NJ 07981 • 973-560-0019 • FAX: 973-560-0076
e-mail: sales@powerdynamics.com • www.powerdynamics.com

EXAMPLE & ORDERING CODE

CRIMP SHELLS PDI - **15** **R** **H** S - C - **H**

NUMBER OF PINS:	
STANDARD	= 9 = 15 = 25 = 37
HIGH DENSITY	= 15 = 26 = 44 = 62

GENDER:	
MALE	= S
FEMALE	= R

SPACING:	
STANDARD	= BLANK
HIGH DENSITY	= H

MATING FACE:	
2.5mm HEX RIVET	= BLANK
HOLE	= H
RIVETED HEX STANDOFF	= K
4-40 THREADED RIVET AND JACK SCREW (JACK SCREW UNASSEMBLED)	= P
4-40 THREADED RIVET AND JACK SCREW	= R

7

D-SUB CONNECTORS

SPECIFICATIONS

MATERIAL AND FINISH:

Shell:
 Material: Steel
 Plating: Tin
 Thickness: Base Copper: 40µ"
 Tin: 80~120µ"

Insulator:
 P.B.T. and glass-fiber reinforced
 UL 94V-0

Mechanical:

Standard:
 Mating Force: **9 PIN 15 PIN 25 PIN 37 PIN**
 minimum: 1.5 kg 2.0 kg 3.0 kg 3.0 kg
 maximum: 5.0 kg 7.0 kg 8.0 kg 12.0 kg

Unmating Force: **9 PIN 15 PIN 25 PIN 37 PIN**
 minimum: 1.5 kg 2.0 kg 3.5 kg 3.5 kg
 maximum: 5.0 kg 7.0 kg 8.0 kg 12.0 kg

Mechanical:

High Density:
 Mating Force: **15 PIN 26 PIN 44 PIN 62 PIN**
 minimum: 3.0 kg 3.5 kg 4.0 kg 5.0 kg
 maximum: 8.0 kg 9.0 kg 13.0 kg 18.0 kg

Unmating Force: **15 PIN 26 PIN 44 PIN 62 PIN**
 minimum: 3.0 kg 3.5 kg 4.0 kg 6.0 kg
 maximum: 9.0 kg 10.0 kg 13.0 kg 18.0 kg

ELECTRICAL SPECIFICATIONS:

Rated Current: 3A
Rated Voltage: 300 VDC
Insulator Resistance:
 3000 Megaohm min. @ 500 VDC
Contact Resistance: 15 milliohm max.
Dielectric Withstanding Strength:
 1000 VAC for 1 minute
Temperature: -55°C to 105°C



Crimp Shell



PDI-15RS-C-H
(shown)

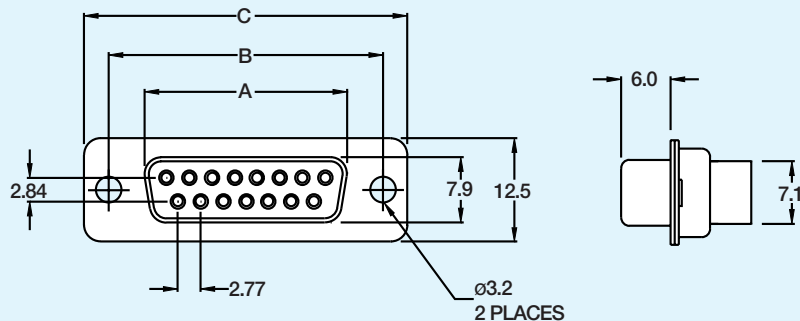

	NUMBER OF PINS			
	9	15	25	37
A	16.30	24.60	38.30	54.80
B	25.00	33.30	47.10	63.50
C	30.80	39.20	53.10	69.40
D	19.20	27.70	41.10	57.30

See pages 196 and 197 for Crimp Pins



PDI-15SS-C-H
(shown)

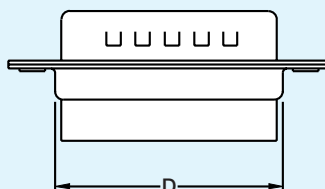
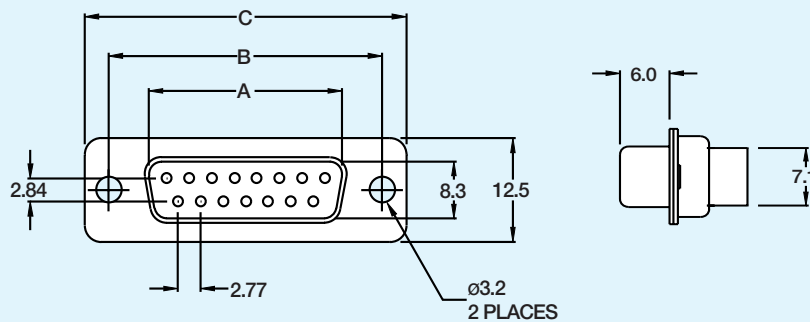

	NUMBER OF PINS			
	9	15	25	37
A	16.92	25.25	38.96	55.42
B	25.00	33.30	47.10	63.50
C	30.80	39.20	53.10	69.40
D	19.20	27.70	41.10	57.30

See pages 196 and 197 for Crimp Pins

Specifications subject to change without notice. Dimensions in mm.
Custom molded cables also available. See page 290.



145 Algonquin Parkway, Whippany, NJ 07981 • 973-560-0019 • FAX: 973-560-0076
e-mail: sales@powerdynamics.com • www.powerdynamics.com

High Density Crimp Shell

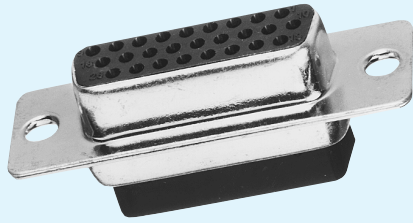

PDI-26RHS-C-H
(shown)

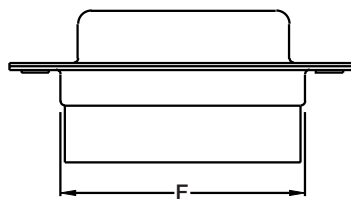
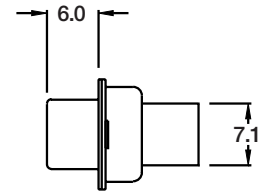
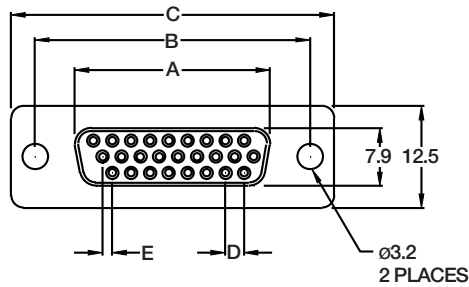

	NUMBER OF PINS			
	15	26	44	62
A	16.30	24.60	38.30	54.80
B	25.00	33.30	47.10	63.50
C	30.80	39.20	53.10	69.40
D	2.29	2.29	2.29	2.41
E	1.14	1.14	1.14	1.20
F	7.04	6.88	6.88	7.00
G	19.20	27.70	41.10	57.30

See pages 196 and 197 for Crimp Pins

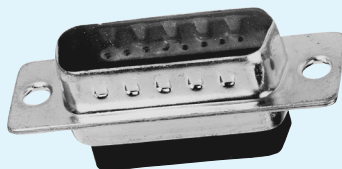

PDI-26SHS-C-H
(shown)

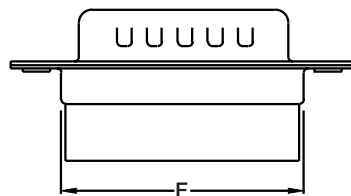
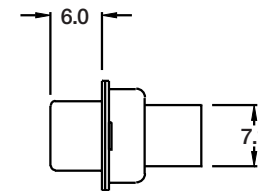
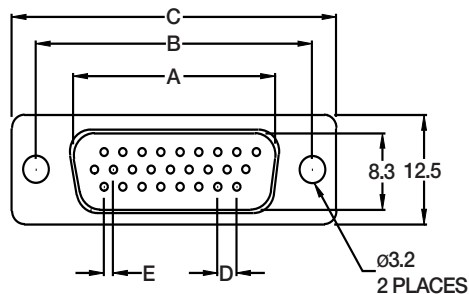

	NUMBER OF PINS			
	15	26	44	62
A	16.92	25.25	38.96	55.42
B	25.00	33.30	47.10	63.50
C	30.80	39.20	53.10	69.40
D	2.29	2.29	2.29	2.41
E	1.14	1.14	1.14	1.20
F	19.20	27.70	41.10	57.30

See pages 196 and 197 for Crimp Pins

Specifications subject to change without notice. Dimensions in mm.
Custom molded cables also available. See page 290.

EXAMPLE & ORDERING CODE

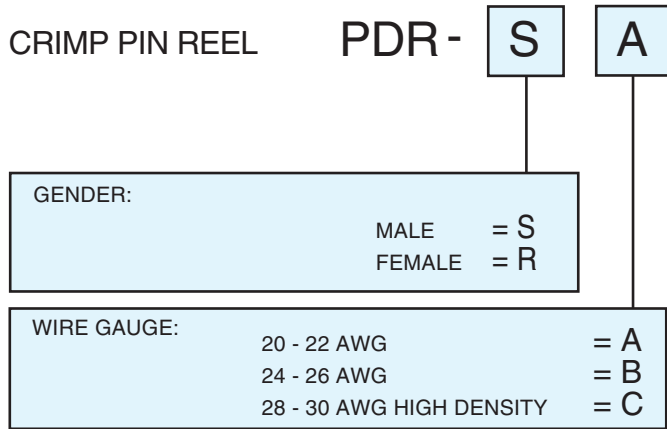

SPECIFICATIONS

Male Contacts:

Material: Brass
 Plating: Gold Plate over Nickel
 Thickness: Gold Flash
 40µ" Nickel base

Female Contacts:

Material: Phosphor Bronze
 Plating: Gold Plate over Nickel
 Thickness: Gold Flash
 40µ" Nickel base



Crimp Pins

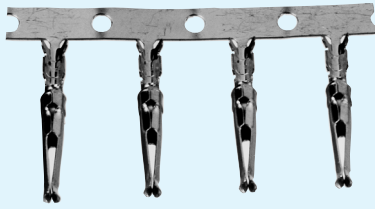

PDR-RB
(shown)

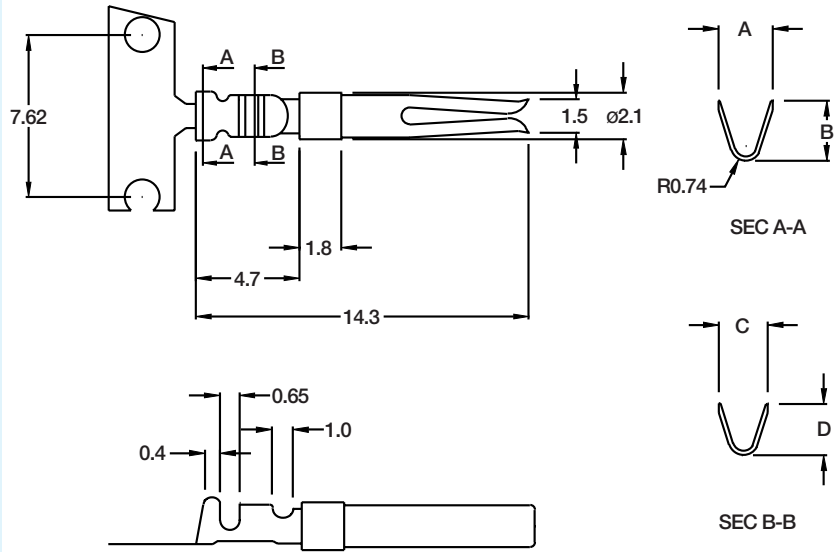

WIRE AWG	A	B	C	D
20-22 AWG	2.8	2.7	2.3	2.1
24-26 AWG	2.1	1.9	1.8	1.36

See pages 193-195 for Crimp Shells

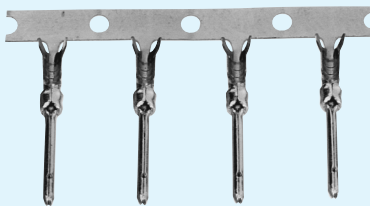

PDR-SB
(shown)

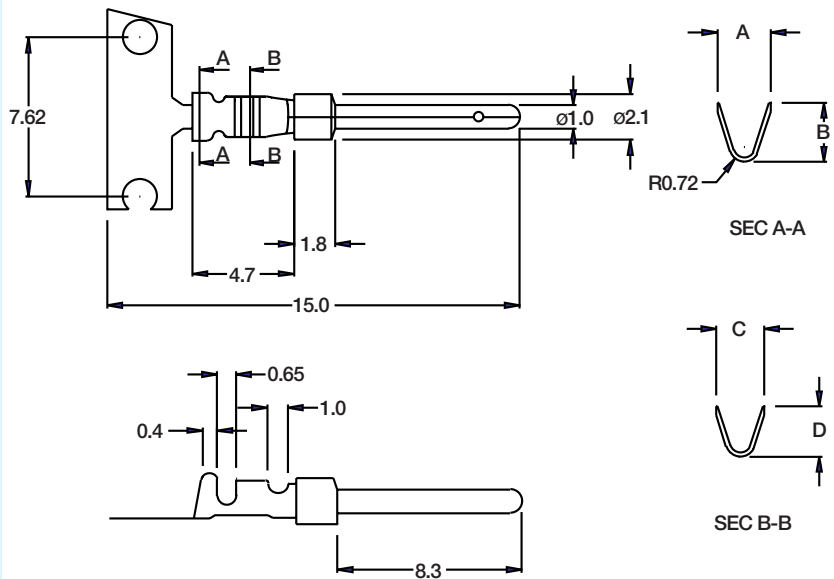

WIRE AWG	A	B	C	D
20-22 AWG	2.8	2.7	2.3	2.1
24-26 AWG	2.1	1.9	1.8	1.36

See pages 193-195 for Crimp Shells

Specifications subject to change without notice. Dimensions in mm.

EXAMPLE & ORDERING CODE

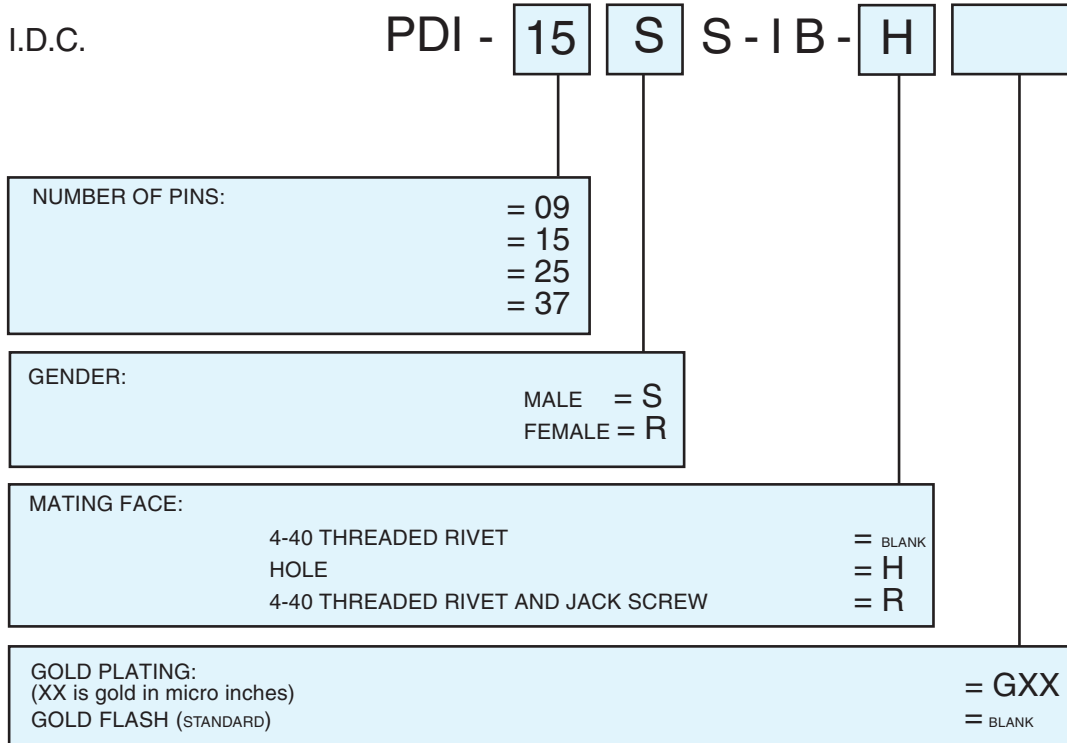

SPECIFICATIONS

MATERIAL AND FINISH:

Shell:

Material: Steel
Plating: Tin
Thickness: Base Copper: 40µ"
Tin: 80~120µ"

Contacts:

Material: Brass (male)
Phosphor Bronze (female)
Plating: Gold Plate and Tin
Thickness: Gold Flash
40µ" Nickel base
80~100µ" Tin

Insulator:

P.B.T. and glass-fiber reinforced
UL 94V-0

Mechanical:

Mating Force:	9 PIN	15 PIN	25 PIN	37 PIN
minimum:	1.5 kg	2.0 kg	3.0 kg	3.0 kg
maximum:	5.0 kg	7.0 kg	8.0 kg	12.0 kg
Unmating Force:	9 PIN	15 PIN	25 PIN	37 PIN
minimum:	1.5 kg	2.0 kg	3.5 kg	3.5 kg
maximum:	5.0 kg	7.0 kg	8.0 kg	12.0 kg

ELECTRICAL SPECIFICATIONS:

Rated Current: 3A
Rated Voltage: 300 VDC
Insulator Resistance:
3000 Megaohm min. @ 500 VDC
Contact Resistance: 15 milliohm max.
Dielectric Withstanding Strength:
1000 VAC for 1 minute
Temperature: -55°C to 105°C



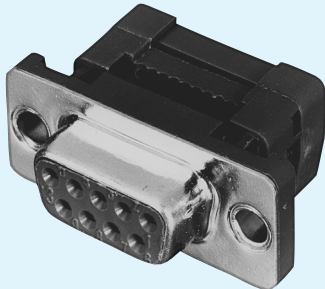

PDI-09RS-IB-H
(shown)

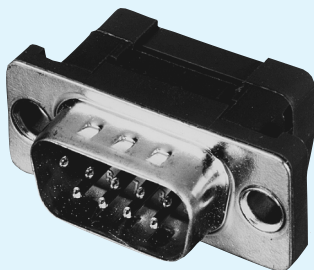
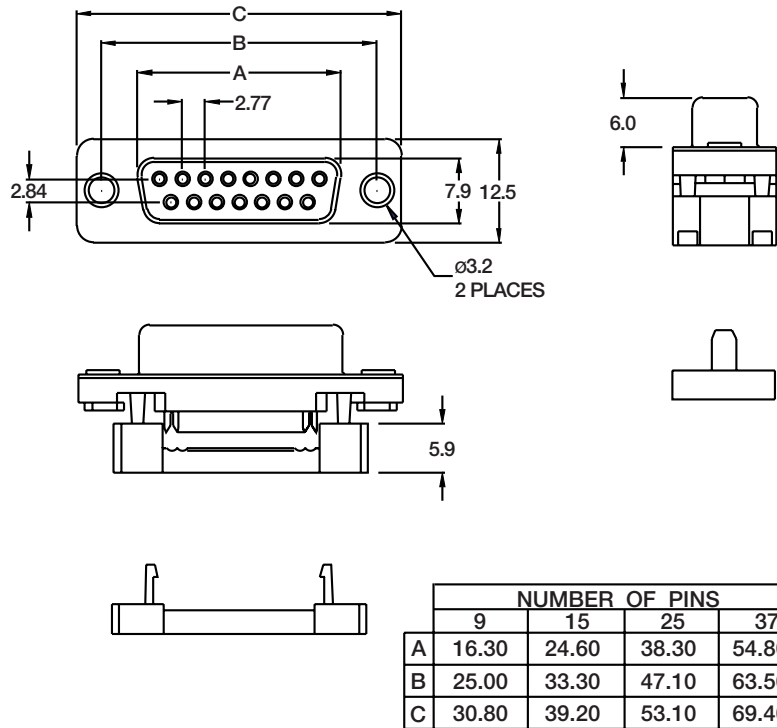

PDI-09SS-IB-H
(shown)

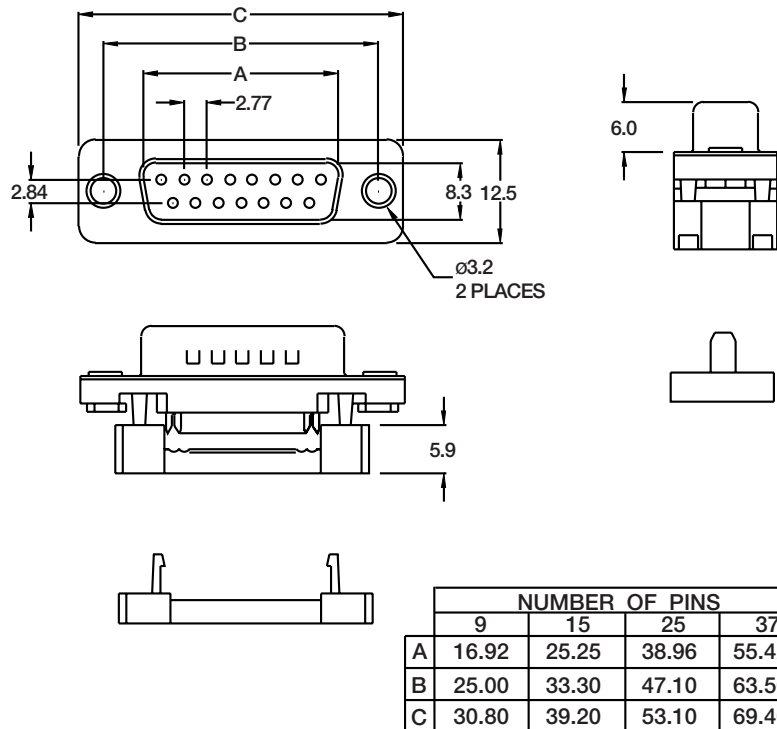

Specifications subject to change without notice. Dimensions in mm.
Custom cables also available. See page 290.

EXAMPLE & ORDERING CODE

RIGHT ANGLE, P.C.B.,
FILTERED

PDF - 15 - S - 9 - J - [] - []

NUMBER OF PINS:	= 09 = 15 = 25 = 37
GENDER:	MALE = S FEMALE = R
FOOT PRINT LENGTH:	7.2mm = BLANK 9.4mm = 9 13.84mm = 13
MATING FACE:	4-40 THREADED RIVET = BLANK JACK SCREW 4-40 THREAD = J RIVETED HEX STANDOFF = K 4-40 THREADED RIVET AND JACK SCREW (UNASSEMBLED) = P 4-40 THREADED RIVET AND JACK SCREW = R
P.C.B. FACE:	BOARD LOCK = BLANK HOLE = H THREADED HOLE = T NO GROUNDING STRAP = Z
GOLD PLATING: (XX is gold in micro inches)	= GXX
GOLD FLASH (STANDARD)	= BLANK

SPECIFICATIONS

MATERIAL AND FINISH:

Shell:
Material: Steel
Plating: Tin
Thickness: Base Copper: 40µ"
Tin: 80-120µ"

Contacts:

Material: Brass (male)
Phosphor Bronze (female)
Plating: Gold Plate or Tin
Thickness: Gold Flash
40µ" Nickel base
80-100µ" Tin

Insulator:

P.B.T. and glass-fiber reinforced
UL 94V-0

Mechanical:

Mating Force:	9 PIN	15 PIN	25 PIN	37 PIN
minimum:	1.5 kg	2.0 kg	3.0 kg	3.0 kg
maximum:	5.0 kg	7.0 kg	8.0 kg	12.0 kg
Unmating Force:	9 PIN	15 PIN	25 PIN	37 PIN
minimum:	1.5 kg	2.0 kg	3.5 kg	3.5 kg
maximum:	5.0 kg	7.0 kg	8.0 kg	12.0 kg

ELECTRICAL SPECIFICATIONS:

Rated Current: 3A
Rated Voltage: 300 VDC
Insulator Resistance:
3000 Megaohm min. @ 500 VDC
Contact Resistance: 15 milliohm max.
Dielectric Withstanding Strength:
1000 VAC for 1 minute
Temperature: -55°C to 105°C



145 Algonquin Parkway, Whippany, NJ 07981 • 973-560-0019 • FAX: 973-560-0076
e-mail: sales@powerdynamics.com • www.powerdynamics.com

Filtered, Right Angle, P.C.B., 7.2mm Footprint

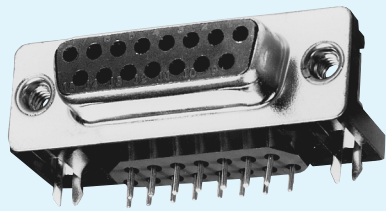

PDF-15R
(shown)

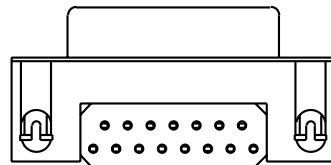
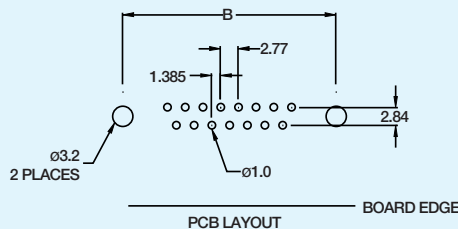
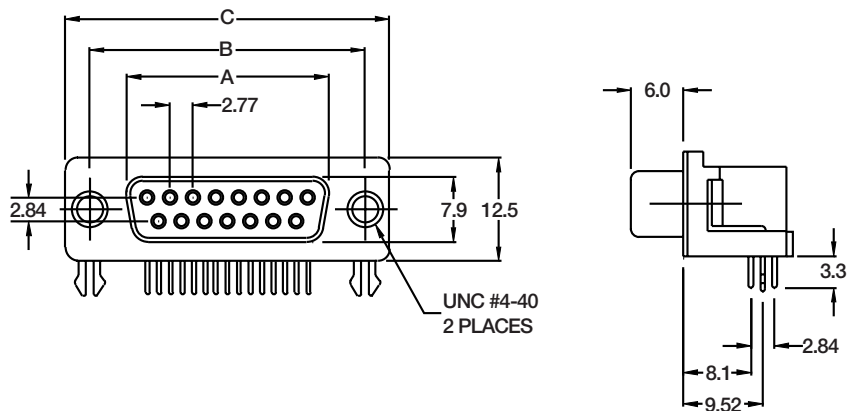

	NUMBER OF PINS			
	9	15	25	37
A	16.30	24.60	38.30	54.80
B	25.00	33.30	47.10	63.50
C	30.80	39.20	53.10	69.40

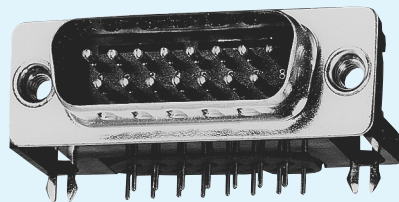

PDF-15S
(shown)

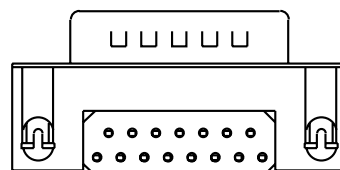
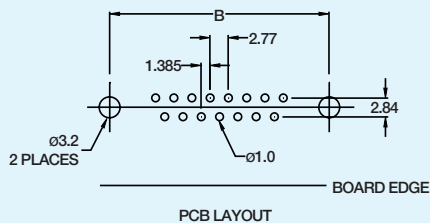
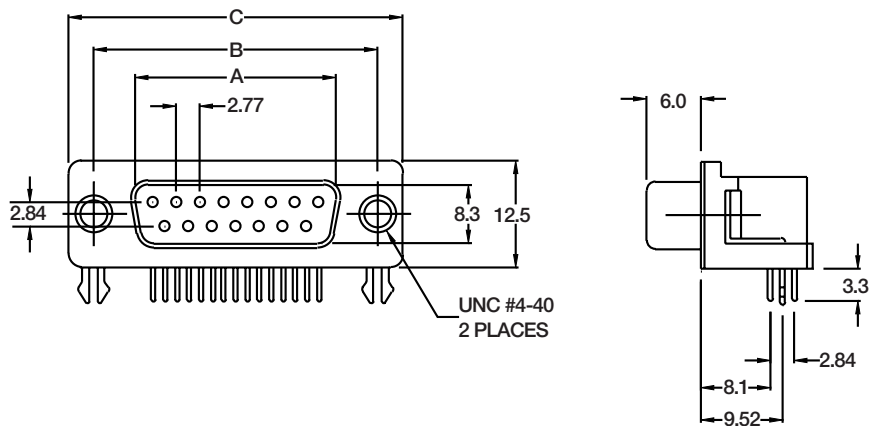

	NUMBER OF PINS			
	9	15	25	37
A	16.92	25.25	38.96	55.42
B	25.00	33.30	47.10	63.50
C	30.80	39.20	53.10	69.40

Specifications subject to change without notice. Dimensions in mm.
See pages 208 and 209 for Attenuation Curves.

145 Algonquin Parkway, Whippany, NJ 07981 • 973-560-0019 • FAX: 973-560-0076
e-mail: sales@powerdynamics.com • www.powerdynamics.com



EXAMPLE & ORDERING CODE

FILTERED, HIGH DENSITY,
RIGHT ANGLE, P.C.B.

PDF - 15 S H- J H

NUMBER OF PINS:	= 15 = 26 = 44 = 62
GENDER:	MALE = S FEMALE = R
MATING FACE:	4-40 THREADED RIVET = BLANK JACK SCREW 4-40 THREAD = J RIVETED HEX STANDOFF = K 4-40 THREADED RIVET AND JACK SCREW (UNASSEMBLED) = P 4-40 THREADED RIVET AND JACK SCREW = R
P.C.B. FACE:	BOARD LOCK = BLANK HOLE = H THREADED HOLE = T NO GROUNDING STRAP = Z
GOLD PLATING: (XX is gold in micro inches) GOLD FLASH (STANDARD)	= GXX = BLANK

SPECIFICATIONS

MATERIAL AND FINISH:

Shell:
 Material: Steel
 Plating: Tin
 Thickness: Base Copper: 40µ"
 Tin: 80~120µ"

Contacts:
 Material: Brass (male)
 Phosphor Bronze (female)
 Plating: Gold Plate or Tin,
 Gold Flash
 Thickness: 40µ" Nickel base
 80~100µ" Tin

Insulator:

P.B.T. and glass-fiber reinforced
 UL 94V-0

Mechanical:

Mating Force:	15 PIN	26 PIN	44 PIN	62 PIN
minimum:	3.0 kg	3.5 kg	4.0 kg	5.0 kg
maximum:	8.0 kg	9.0 kg	13 kg	18 kg
Unmating Force:	15 PIN	26 PIN	44 PIN	62 PIN
minimum:	3.0 kg	3.5 kg	4.0 kg	6.0 kg
maximum:	9.0 kg	10 kg	13 kg	18 kg

ELECTRICAL SPECIFICATIONS:

Rated Current: 3A
Rated Voltage: 300 VDC
Insulator Resistance:
 3000 Megaohm min. @ 500 VDC
Contact Resistance: 15 milliohm max.
Dielectric Withstanding Strength:
 1000 VAC for 1 minute
Temperature: -55°C to 105°C



145 Algonquin Parkway, Whippany, NJ 07981 • 973-560-0019 • FAX: 973-560-0076
 e-mail: sales@powerdynamics.com • www.powerdynamics.com

Filtered, High Density, Right Angle

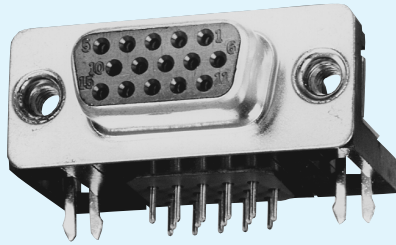

PDF-15RH
(shown)

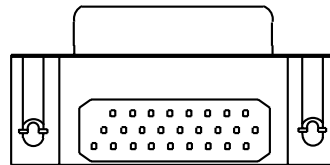
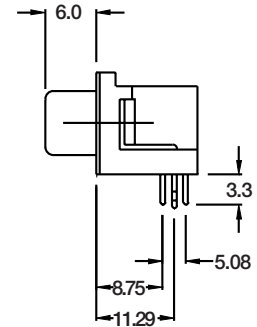
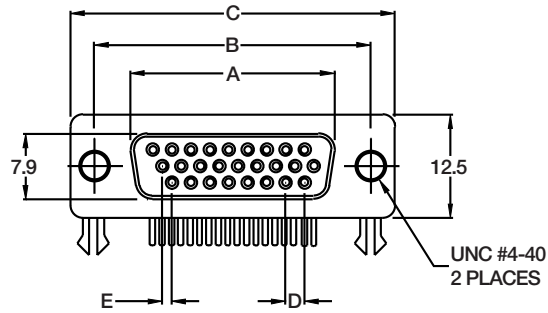
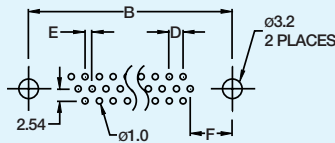
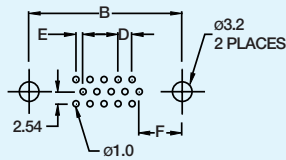

	NUMBER OF PINS			
	15	26	44	62
A	16.30	24.60	38.30	54.80
B	25.00	33.30	47.10	63.50
C	30.80	39.20	53.10	69.40
D	2.29	2.29	2.29	2.41
E	1.145	1.145	1.145	1.205
F	7.04	6.88	6.88	7.00

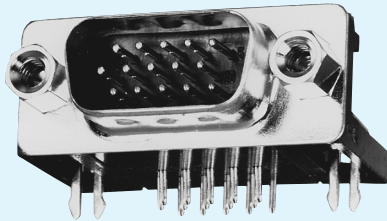

PDF-15SH-J
(shown)

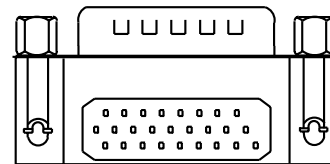
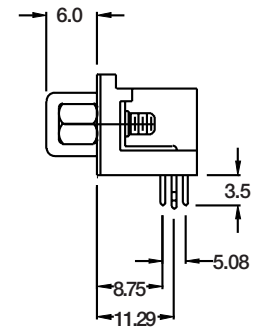
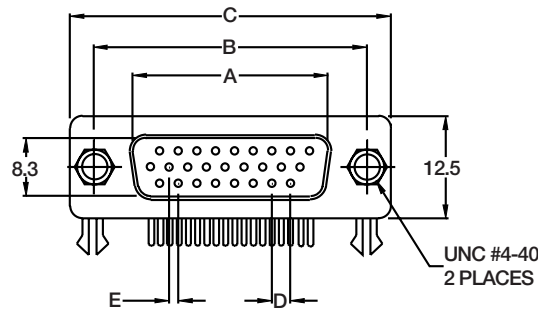
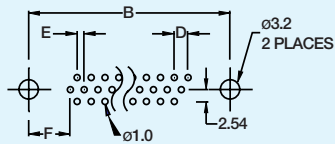
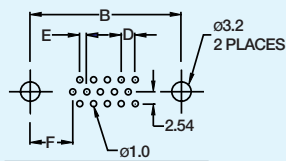

	NUMBER OF PINS			
	15	26	44	62
A	16.92	25.25	38.96	55.42
B	25.00	33.30	47.10	63.50
C	30.80	39.20	53.10	69.40
D	2.29	2.29	2.29	2.41
E	1.145	1.145	1.145	1.205
F	7.04	6.88	6.88	7.00

Specifications subject to change without notice. Dimensions in mm.
See pages 208 and 209 for Attenuation Curves.

EXAMPLE & ORDERING CODE

FILTERED, STRAIGHT PDF - **15** **S** **S** - **S** **W** - **H**

NUMBER OF PINS:	= 09 = 15 = 25 = 37																		
GENDER:	MALE = S FEMALE = R																		
TERMINATION TYPE:	P.C. PINS = BLANK SOLDER CUP = S EXTENDED P.C. PINS = E																		
INSULATOR COLOR:	BLACK = BLANK WHITE = W																		
MATING FACE:	<table style="width: 100%; border-collapse: collapse;"> <tr><td style="width: 80%;">2.5mm HEX RIVET</td><td style="text-align: right;">= BLANK</td></tr> <tr><td>3.8mm RIVET ATTACHED IN BACK</td><td style="text-align: right;">= A</td></tr> <tr><td>5.8mm RIVET ATTACHED IN BACK</td><td style="text-align: right;">= D</td></tr> <tr><td>5.8mm BOARD LOCK</td><td style="text-align: right;">= G</td></tr> <tr><td>HOLE</td><td style="text-align: right;">= H</td></tr> <tr><td>5.8MM RIVET ATTACHED IN FRONT</td><td style="text-align: right;">= K</td></tr> <tr><td>4-40 THREADED RIVET AND JACK SCREW (JACK SCREW UNASSEMBLED)</td><td style="text-align: right;">= P</td></tr> <tr><td>4-40 THREADED RIVET AND JACK SCREW</td><td style="text-align: right;">= R</td></tr> <tr><td>11.9mm BOARD LOCK</td><td style="text-align: right;">= U</td></tr> </table>	2.5mm HEX RIVET	= BLANK	3.8mm RIVET ATTACHED IN BACK	= A	5.8mm RIVET ATTACHED IN BACK	= D	5.8mm BOARD LOCK	= G	HOLE	= H	5.8MM RIVET ATTACHED IN FRONT	= K	4-40 THREADED RIVET AND JACK SCREW (JACK SCREW UNASSEMBLED)	= P	4-40 THREADED RIVET AND JACK SCREW	= R	11.9mm BOARD LOCK	= U
2.5mm HEX RIVET	= BLANK																		
3.8mm RIVET ATTACHED IN BACK	= A																		
5.8mm RIVET ATTACHED IN BACK	= D																		
5.8mm BOARD LOCK	= G																		
HOLE	= H																		
5.8MM RIVET ATTACHED IN FRONT	= K																		
4-40 THREADED RIVET AND JACK SCREW (JACK SCREW UNASSEMBLED)	= P																		
4-40 THREADED RIVET AND JACK SCREW	= R																		
11.9mm BOARD LOCK	= U																		
GOLD PLATING: (XX is gold in micro inches)	= GXX																		
GOLD FLASH (STANDARD)	= BLANK																		

SPECIFICATIONS

MATERIAL AND FINISH:

Shell:
 Material: Steel
 Plating: Tin
 Thickness: Base Copper: 40µ"
 Tin: 80-120µ"

Contacts:
 Material: Brass (male)
 Phosphor Bronze (female)
 Plating: Gold Plate or Tin
 Thickness: Gold Flash
 40µ" Nickel base
 80-100µ" Tin.

Insulator:
 P.B.T. and glass-fiber reinforced
 UL 94V-0

Mechanical:

Mating Force:	9 PIN	15 PIN	25 PIN	37 PIN
minimum:	1.5 kg	2.0 kg	3.0 kg	3.0 kg
maximum:	5.0 kg	7.0 kg	8.0 kg	12.0 kg

Unmating Force: **9 PIN** **15 PIN** **25 PIN** **37 PIN**
 minimum: 1.5 kg 2.0 kg 3.5 kg 3.5 kg
 maximum: 5.0 kg 7.0 kg 8.0 kg 12.0 kg

ELECTRICAL SPECIFICATIONS:

Rated Current: 3A

Rated Voltage: 300 VDC

Insulator Resistance:
 3000 Megaohm min. @ 500 VDC

Contact Resistance: 15 milliohm max.

Dielectric Withstanding Strength:
 1000 VAC for 1 minute

Temperature: -55°C to 105°C



145 Algonquin Parkway, Whippany, NJ 07981 • 973-560-0019 • FAX: 973-560-0076
 e-mail: sales@powerdynamics.com • www.powerdynamics.com

Board Mount Options, Filtered, Straight

TERMINATION TYPE

MATING FACE OPTIONS

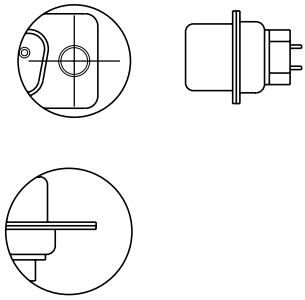
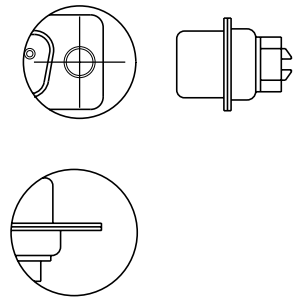
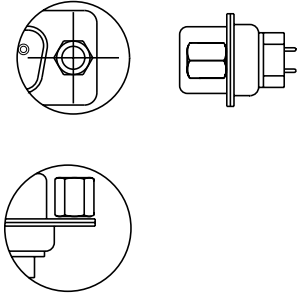
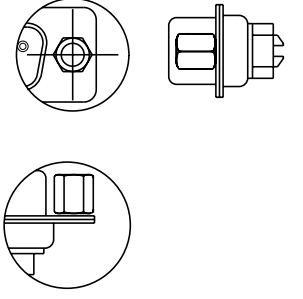
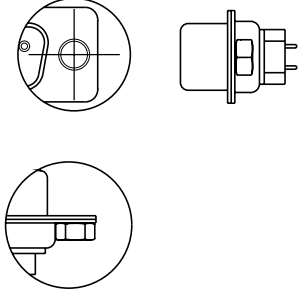
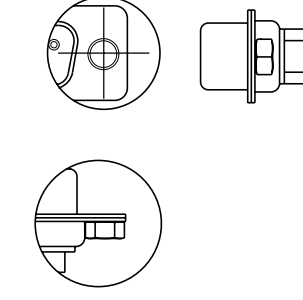
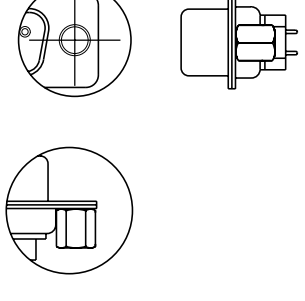
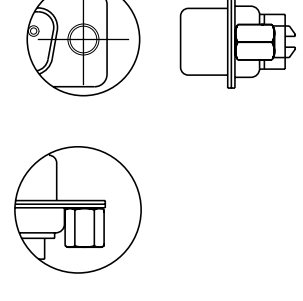
	P. C. PINS	SOLDER CUPS
HOLE		
5.8mm RIVET ATTACHED IN FRONT		
2.5mm HEX RIVET		
5.8mm RIVET ATTACHED IN BACK		

Filtered, Straight, P.C. Pins

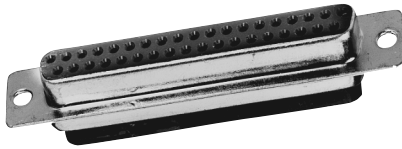

PDF-37RS-H
(shown)

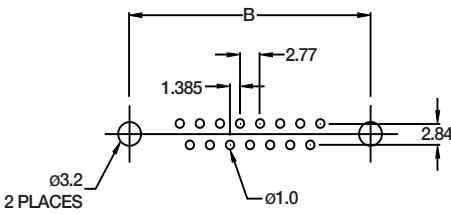
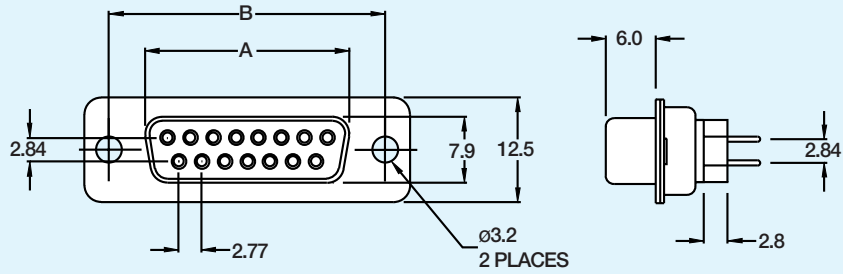

PCB LAYOUT

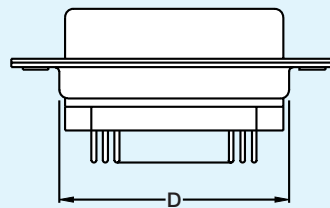

NUMBER OF PINS				
	9	15	25	37
A	16.30	24.60	38.30	54.80
B	25.00	33.30	47.10	63.50
C	30.80	39.20	53.10	69.40
D	19.20	27.70	41.10	57.30

7

D-SUB CONNECTORS



PDF-37SS-H
(shown)

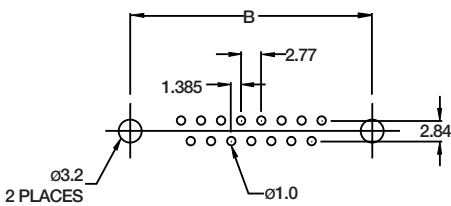
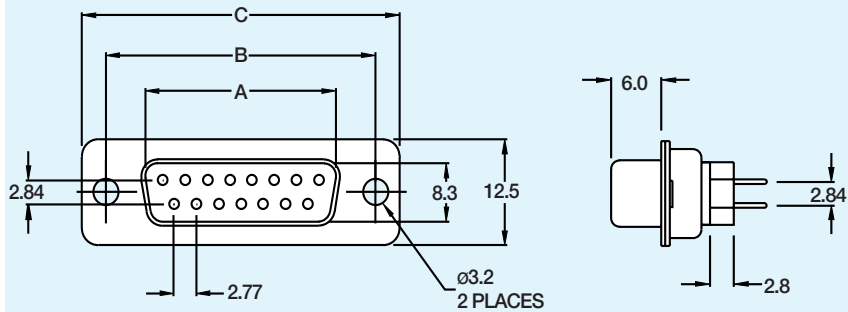

PCB LAYOUT

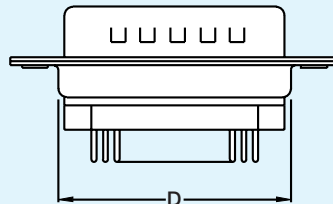

NUMBER OF PINS				
	9	15	25	37
A	16.92	25.25	38.96	55.42
B	25.00	33.30	47.10	63.50
C	30.80	39.20	53.10	69.40
D	19.20	27.70	41.10	57.30

Specifications subject to change without notice. Dimensions in mm.
See pages 208 & 209 for Attenuation Curves.



145 Algonquin Parkway, Whippany, NJ 07981 • 973-560-0019 • FAX: 973-560-0076
e-mail: sales@powerdynamics.com • www.powerdynamics.com

Filtered, Straight, Solder Cup

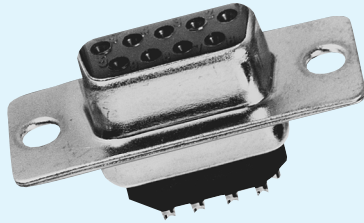

PDF-09RS-S-H
(shown)

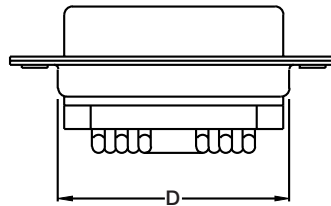
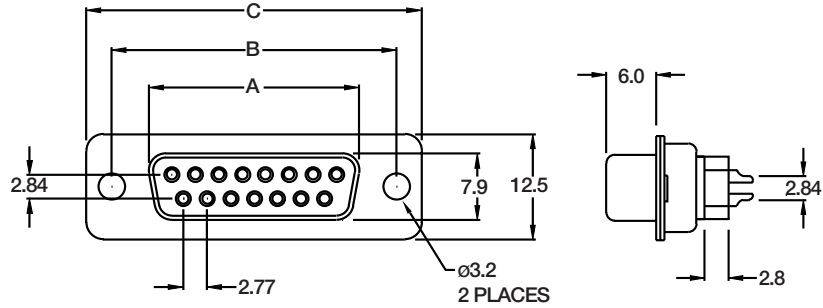

	NUMBER OF PINS			
	9	15	25	37
A	16.30	24.60	38.30	54.80
B	25.00	33.30	47.10	63.50
C	30.80	39.20	53.10	69.40
D	19.20	27.70	41.10	57.30

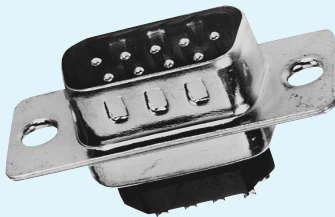

PDF-09SS-S-H
(shown)

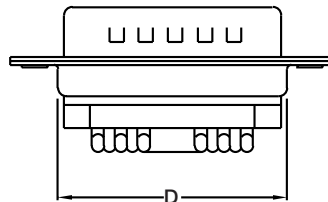
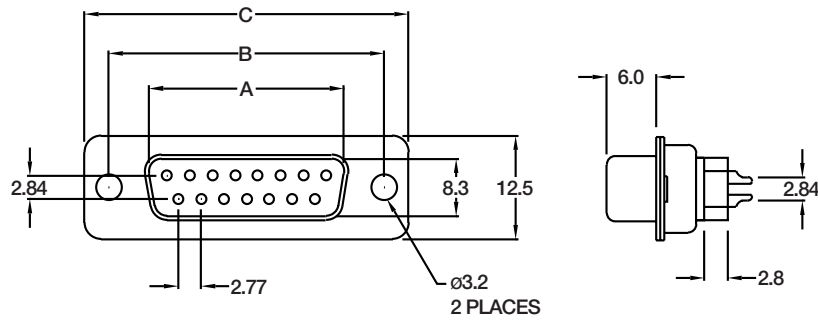

	NUMBER OF PINS			
	9	15	25	37
A	16.92	25.25	38.96	55.42
B	25.00	33.30	47.10	63.50
C	30.80	39.20	53.10	69.40
D	19.20	27.70	41.10	57.30

Specifications subject to change without notice. Dimensions in mm.
See pages 208 and 209 for Attenuation Curves.
Custom molded cables also available. See page 290.
D-Sub Covers see pages 210 and 211.

145 Algonquin Parkway, Whippany, NJ 07981 • 973-560-0019 • FAX: 973-560-0076
e-mail: sales@powerdynamics.com • www.powerdynamics.com



Attenuation Curves

9 Pin

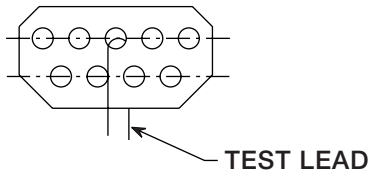

EQUIPMENT USED:
 HP-4191A RF IMPEDANCE TESTER
 HP-16093A BINDING POST FIXTURE
 TEST LEAD WIRE LENGTH: 80mm
 NUMBER OF TURNS: 1/2
 WIRE DIAMETER: 1.0mm

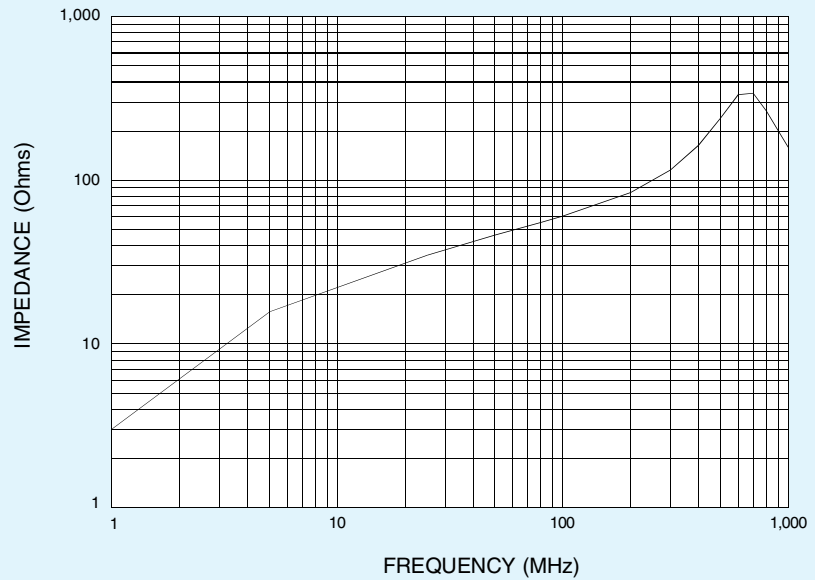

15 Pin

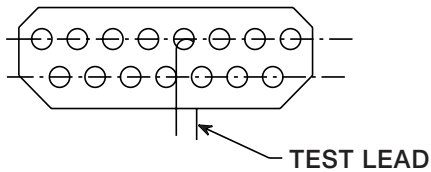

EQUIPMENT USED:
 HP-4191A RF IMPEDANCE TESTER
 HP-16093A BINDING POST FIXTURE
 TEST LEAD WIRE LENGTH: 63mm
 NUMBER OF TURNS: 1/2
 WIRE DIAMETER: 0.6mm

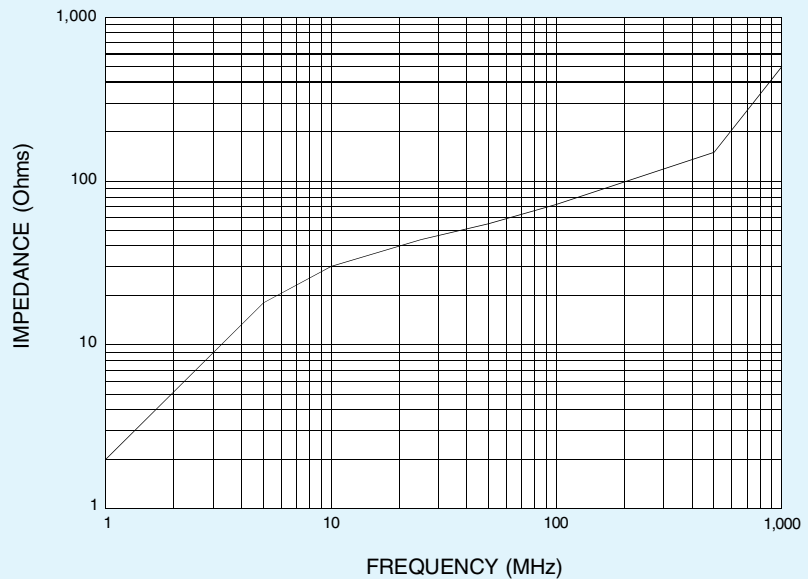

Specifications subject to change without notice.



145 Algonquin Parkway, Whippany, NJ 07981 • 973-560-0019 • FAX: 973-560-0076
 e-mail: sales@powerdynamics.com • www.powerdynamics.com

Attenuation Curves

15 Pin High Density

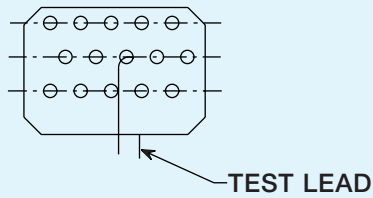

EQUIPMENT USED:
 HP-4191A RF IMPEDANCE TESTER
 HP-16093A BINDING POST FIXTURE
 TEST LEAD WIRE LENGTH: 80mm
 NUMBER OF TURNS: 1/2
 WIRE DIAMETER: 1.0mm

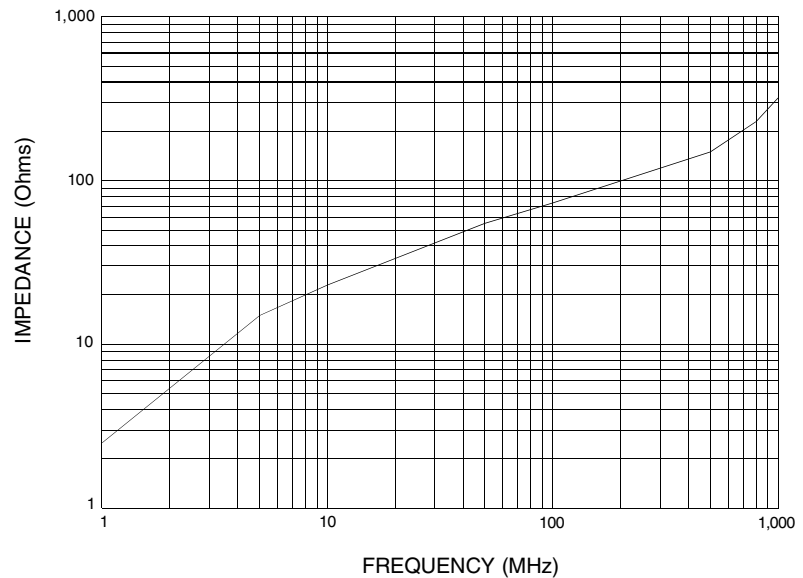

25 Pin

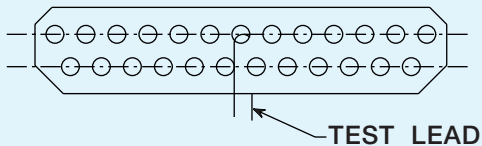

EQUIPMENT USED:
 HP-4191A RF IMPEDANCE TESTER
 HP-16093A BINDING POST FIXTURE
 TEST LEAD WIRE LENGTH: 80mm
 NUMBER OF TURNS: 1/2
 WIRE DIAMETER: 0.4mm

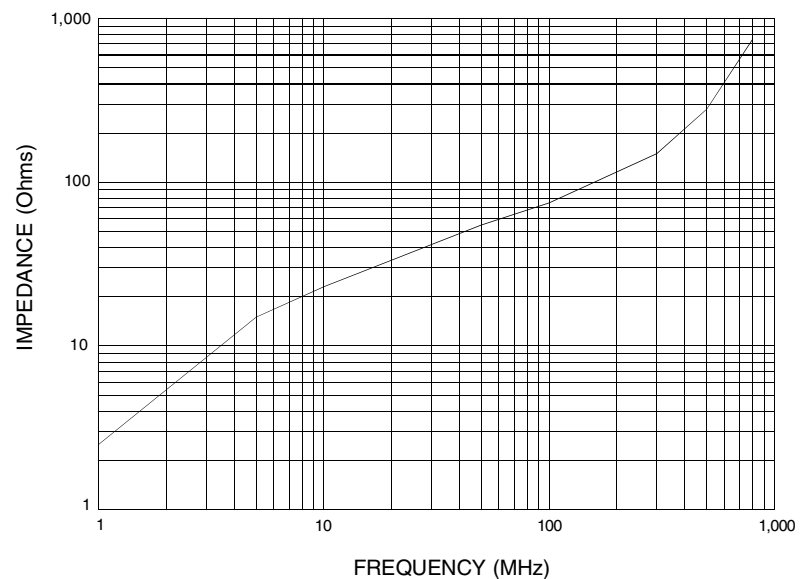

Specifications subject to change without notice.

EXAMPLE & ORDERING CODE

COVERS

PD **P** - **15** C - **G** - **S**

SHELL TYPE:
 PLASTIC = P
 METAL = M

D-SUB SIZE (NUMBER OF PINS):
 = 09
 = 15
 = 25
 = 37

HIGH DENSITY:
 15 USE 09
 26 USE 15
 44 USE 25
 62 USE 37

COLOR (FOR PLASTIC ONLY):
 GRAY = G
 BLACK = B

MATING FACE:
 SHORT SCREW = S
 THUMB SCREW = T



145 Algonquin Parkway, Whippany, NJ 07981 • 973-560-0019 • FAX: 973-560-0076
 e-mail: sales@powerdynamics.com • www.powerdynamics.com

Covers, Metal and Plastic

PDM-37C-T
(shown)

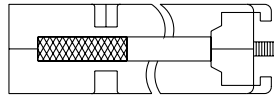
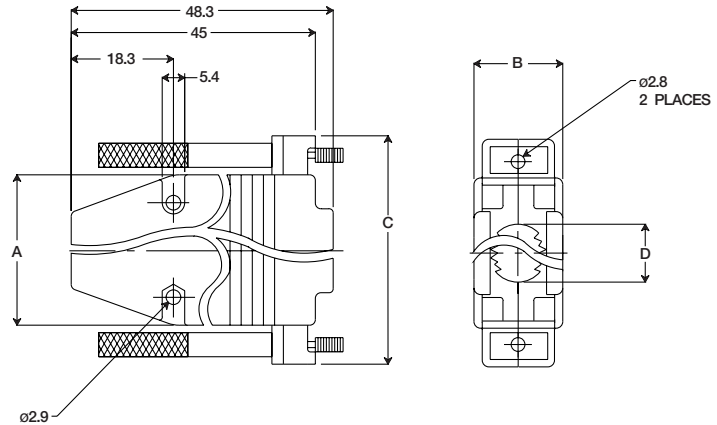
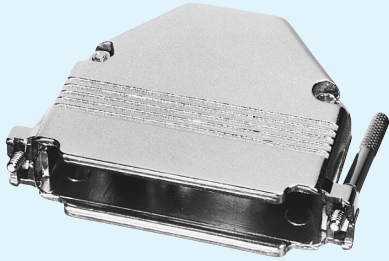

DIMENSIONS				
	A	B	C	D
9 PIN	20.00	15.60	31.00	8.50
15 PIN	27.90	15.80	40.00	10.00
25 PIN	41.50	16.00	53.50	11.00
37 PIN	57.80	16.00	69.20	14.00

PDP-15C-G-T
(shown)

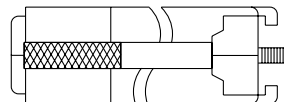
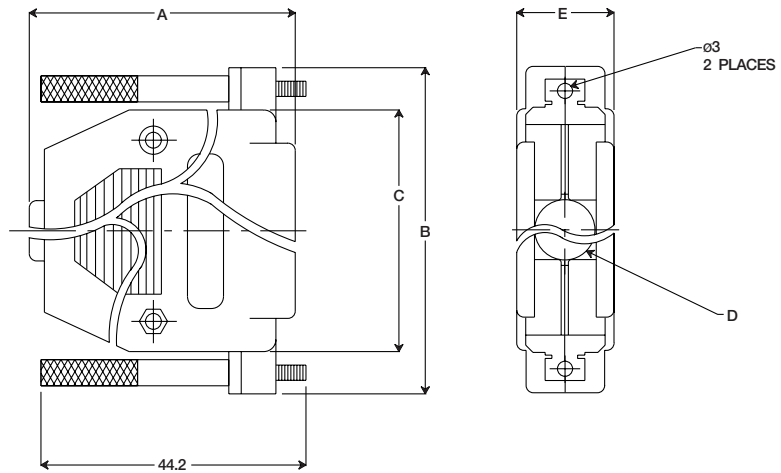
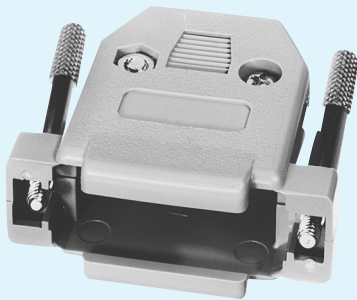

DIMENSIONS					
	A	B	C	D	E
9 PIN	40.50	30.95	20.50	Ø8.5	16.00
15 PIN	36.80	39.50	27.50	Ø10.0	16.00
25 PIN	44.00	55.00	41.00	Ø11.0	16.00
37 PIN	52.80	69.40	57.80	Ø14.0	24.75

Specifications subject to change without notice. Dimensions in mm.

EXAMPLE & ORDERING CODE

D-SUB TO
PHONE JACK

PDI- 15 S - 8 P 8 C - S

NUMBER OF D-SUB CONTACTS:	= 09
	= 15
	= 25
GENDER:	MALE = S
	FEMALE = R
NUMBER OF POSITIONS:	= 4
	= 6
	= 8
	= 10
NUMBER OF CONTACTS:	= 2
	= 4
	= 6
	= 8
	= 10
BODY COLOR:	GRAY = BLANK
	BLACK = B
SCREW TYPE:	THUMB SCREW = BLANK
	STANDARD PHILLIPS SCREW = S

SPECIFICATIONS

MATERIAL AND FINISH (D-SUB):

Shell:

Material: Steel
 Plating: Tin
 Thickness: Base Copper: 40µ"
 Tin: 80~120µ"

Contacts:

Material: Brass (male)
 Brass or Phosphor Bronze (female)
 Plating: Gold Plate over Nickel
 Thickness: Gold Flash
 40µ" Nickel base

Insulator:

P.B.T. and glass-fiber reinforced
 UL 94V-0

Mechanical:

Mating Force:	9 PIN	15 PIN	25 PIN
minimum:	1.5 kg	2.0 kg	3.0 kg
maximum:	5.0 kg	7.0 kg	8.0 kg
Unmating Force:	9 PIN	15 PIN	25 PIN
minimum:	1.5 kg	2.0 kg	3.5 kg
maximum:	5.0 kg	7.0 kg	8.0 kg

ELECTRICAL SPECIFICATIONS:

Rated Current: 3A
Rated Voltage: 300 VDC
Insulator Resistance:
 3000 Megaohm min. @ 500 VDC
Contact Resistance: 15 milliohm max.
Dielectric Withstanding Strength:
 1000 VAC for 1 minute
Temperature: -55°C to 105°C



145 Algonquin Parkway, Whippany, NJ 07981 • 973-560-0019 • FAX: 973-560-0076
 e-mail: sales@powerdynamics.com • www.powerdynamics.com

D-Sub to Phone Jack

PDI-09R-8P8C

(shown)

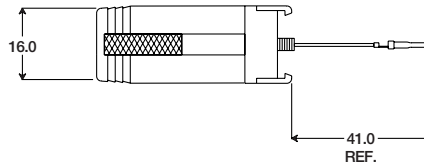
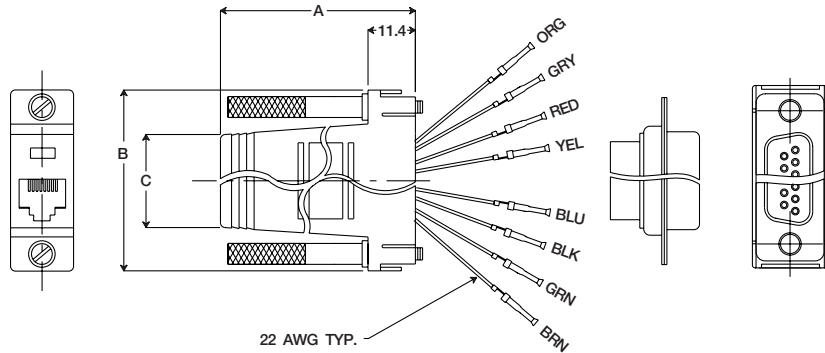
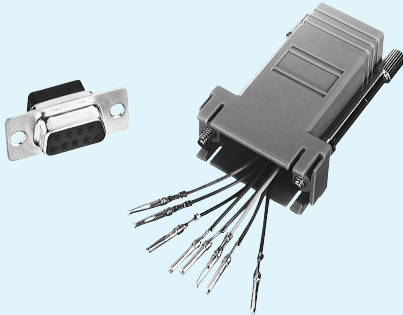

WIRE DESIGNATION		
POS #	TO	COLOR
1	→	BLU
2	→	ORG
3	→	BLK
4	→	RED
5	→	GRN
6	→	YEL
7	→	BRN
8	→	GRY

DIMENSIONS			
	A	B	C
9 PIN	49.30	32.80	19.60
15 PIN	39.30	41.50	23.00
25 PIN	39.30	55.00	34.00

Specifications subject to change without notice. Dimensions in mm.

D-Sub to Phone Jack

PDI-25S-8P8C

(shown)

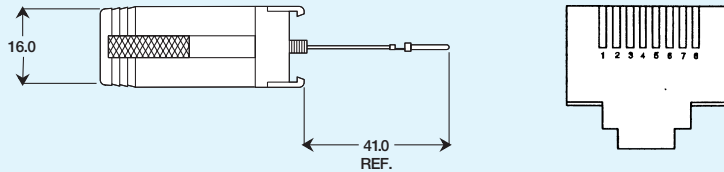
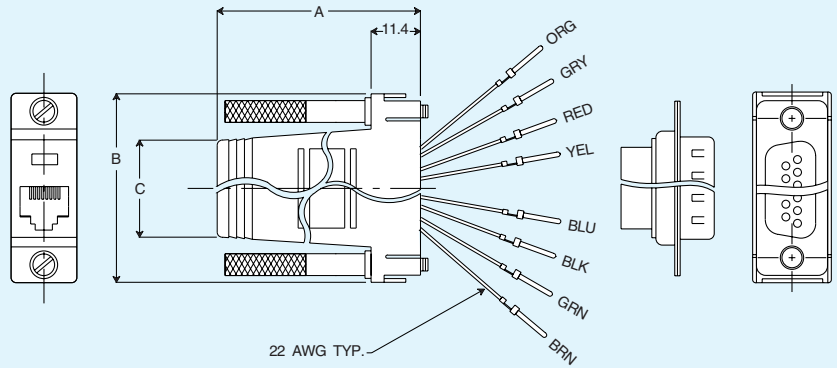
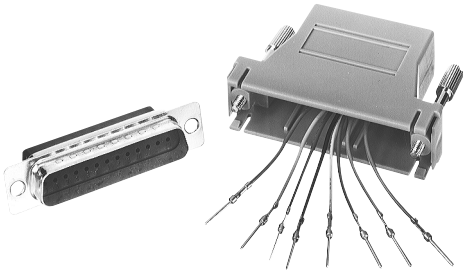

WIRE POS #	DESIGNATION TO	COLOR
1	→	BLU
2	→	ORG
3	→	BLK
4	→	RED
5	→	GRN
6	→	YEL
7	→	BRN
8	→	GRY

DIMENSIONS			
	A	B	C
9 PIN	49.30	32.80	19.60
15 PIN	39.30	41.50	23.00
25 PIN	39.30	55.00	34.00

Specifications subject to change without notice. Dimensions in mm.
See pages 208 and 209 for Attenuation Curves.



145 Algonquin Parkway, Whippany, NJ 07981 • 973-560-0019 • FAX: 973-560-0076
e-mail: sales@powerdynamics.com • www.powerdynamics.com