

CBM-90-IRD-X33-850nm

Mosaic Array Series

Infrared Chip On Board LEDs

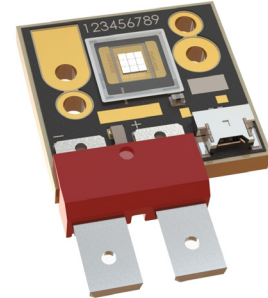

Table of Contents

Technology Overview	2
Product Binning.	3
Ordering Information	4
Optical and Electrical Characteristics	5
Mech. Dimensions	8
Tray Information	9
Shipping information	10
Revision History.	11

Features

- Mosaic Array Infrared LED chipset with surface emitting area of 9 mm²
- Vertical chip LED technology for high power density and uniform emission
- High thermal conductivity copper coreboard package
- Can be operated at variable drive currents up to 18A

Applications

- Medical and Scientific Instrumentation
- Fiber-coupled illumination
- Inspection
- Machine Vision

Technology Overview

Luminus CBM-90-IRD-X33 LEDs benefit from innovations in device technology, chip packaging and thermal management. This suite of technologies give engineers and system designers the freedom to develop solutions both high in power and efficiency.

Reliability

Luminus CBM-90-IRD-X33 LEDs have passed a rigorous suite of environmental and mechanical stress tests, including mechanical shock, vibration, temperature cycling and humidity. They are fully qualified for use in a wide range of high performance and high efficacy applications.

REACH & RoHS Compliance

The Luminus CBM-90-IRD-X33 LED is compliant to the Restriction of Hazardous Substances Directive or RoHS. The restricted materials including lead, mercury cadmium hexavalent chromium, polybrominated biphenyls (PBB) and polybrominated diphenyl ether (PBDE) are not used.

Understanding Luminus CBM-90-IRD-X33 LED Test Specifications

Every Luminus LED is fully tested to ensure it meets the high quality standards customers have come to expect from Luminus products.

Testing Temperature

Luminus CBM-90-IRD-X33 LEDs are tested and binned at 40°C heatsink temperature. Temperature curves are provided to allow users to scale the data for actual operating temperature conditions.

CBM-90-IRD Binning Structure

All CBM-90-IRD LEDs are tested for radiometric power / peak wavelength and placed into one of the following flux / wavelength bins.

Flux Bins¹

Bin Code	Radiometric Power at 13.5A, $t_p=20ms$	
	Minimum Flux (W)	Maximum Flux (W)
K	11	12.1
L	12.1	13.31
M	13.31	14.64
N	14.64	16.11
P	16.11	17.72

Note 1: Luminus maintains a +/-6% tolerance in flux measurements.

Wavelength Bins

Bin Code	Minimum Peak Wavelength (nm)	Maximum Peak Wavelength (nm)
840	840	845
845	845	850
850	850	855
855	855	860
860	860	865
865	865	870

Product Ordering and Shipping Part Number Nomenclature

All CBM-90-IRD-X33 products are packaged and labeled with part numbers as outlined in below. When shipped, each tray will contain only a single flux wavelength and Vf bin. The part number designation is as follows:

Products	Ordering Part Number	Description
CBM-90-IRD-X33	CBM-90-IRD-X33-F###	CBM-90-IRD Array chipset consisting of 9x1mm ² dual junction Infrared LEDs, a thermistor, connectors, and a square copper-core PCB.

CBM — **90** — **IRD** — **X33** — **F###**

Product Family	Chip Area	Color	Package Configuration	Bin Kit ^{1,2}
CBM: Copper-core PCB, Multi Chip Array, No Encapsulation	90: 9 mm ²	IRD = Dual junction Infrared	X33: 28 mm x 26.75 mm - Common Anode Package See Mechanical Drawing section	See below for flux and wavelength binning information

Typ. Centroid Wavelength (nm)	Minimum Flux Bin (W)	Lens Angle	Ordering Part Number
850	K	120 (Lambertian)	<i>CBM-90-IRD-X33-K850</i>

Optical and Electrical Characteristics

Optical and Electrical Characteristics¹

Parameter	Symbol	Package Type	Unit
		X33-850	
Forward Current	I_f	13.5	A
Output Power Typical	PO_{typ}	13	W
Minimum Forward Voltage ¹	V_{fmin}	3.0	V
Forward Voltage Typical	V_f	3.6	V
Maximum Forward Voltage ¹	V_{fmax}	4.0	V
Viewing Angle	$2\theta_{1/2}$	120	deg
Peak Wavelength Typical	λ_p	855	nm
Centroid Wavelength Typical	λ_c	850	nm
FWHM Typical	$\Delta\lambda_{1/2}$	35	nm
Temperature Coefficient of Forward voltage	TC_{Vf}	-2	mV/°C
Temperature Coefficient of Radiometric Power	TC_{PO}	-0.3	%/°C
Temperature Coefficient of Wavelength	TC_{λ}	0.2	nm/°C
Thermal Resistance (Electrical)	$R_{th (t-b)}$	0.5	°C/W
Emitting Area		10.24	mm ²
Emitting Area Dimensions		3.2 x 3.2	mm ²

Note 1: Parts are tested and binned at a current of 13.5A, 20ms single pulse and a constant heatsink temperature of $T_{hs} = 40^\circ\text{C}$.

Optical and Electrical Characteristics

Absolute Ratings^{2,5}

Parameter	Symbol	Rating	Unit
Absolute Minimum Current (CW or pulse) ^{3,4}		0.2	A
Absolute Maximum Current (CW) ^{3,4}		18.0	A
Reverse Voltage	V _R	5	V
Storage Temperature	T _{STG}	-40~100	°C
Maximum Junction Temperature ^{3,4}	T _{jmax}	115 °C	°C

Note 2: To prevent damage refer to operating conditions and derating curves for appropriate maximum operating conditions

Note 3: Luminus CBM-90-IRD-X33 LEDs are designed for operation up to an absolute maximum forward drive current as specified above. Product lifetime data is specified at typical forward drive currents. Sustained operation at absolute maximum currents will result in a reduction of device lifetime compared to typical forward drive currents. Actual device lifetimes will also depend on junction temperature.

Note 4: Maximum operating case temperature combined with maximum drive current defines the total maximum operating condition for the device. To prevent damage, please operate devices within specified conditions.

Note 5: Caution must be taken not to stare at the light emitted from these LEDs. Under special circumstances, the high intensity could damage the eye.

Optical and Electrical Characteristics

Relative Output Flux vs. Forward Current

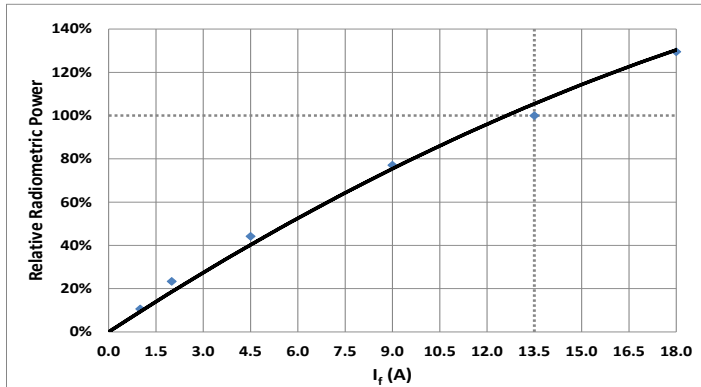

Relative Voltage vs. Forward Current

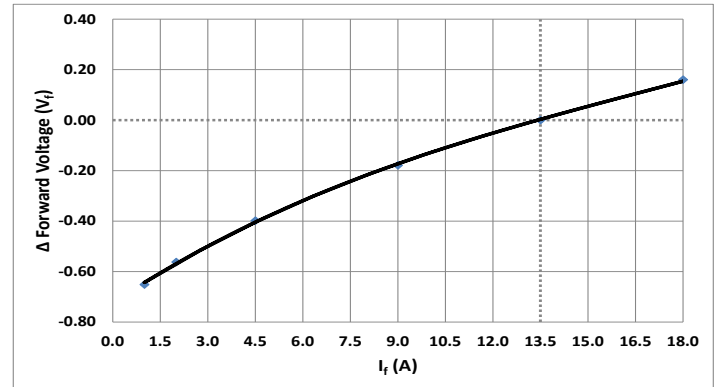

Relative Radiometric Power vs. Temperature

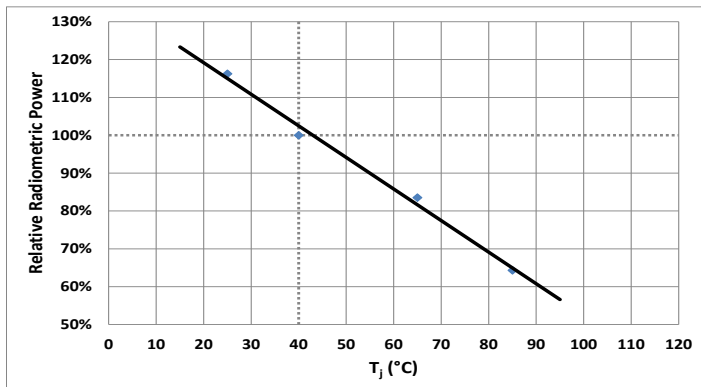

Relative Voltage vs. Temperature

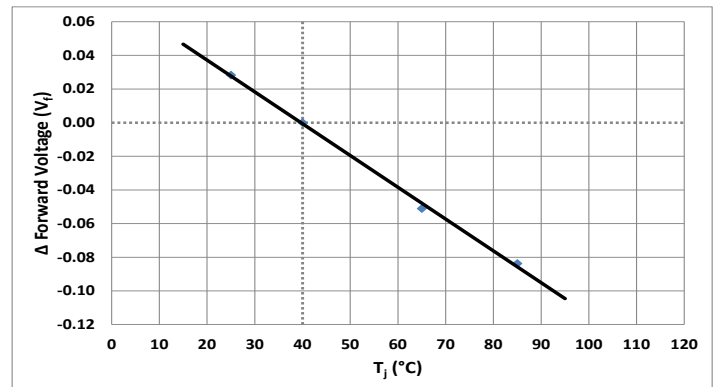

Relative Peak Wavelength vs. Temperature

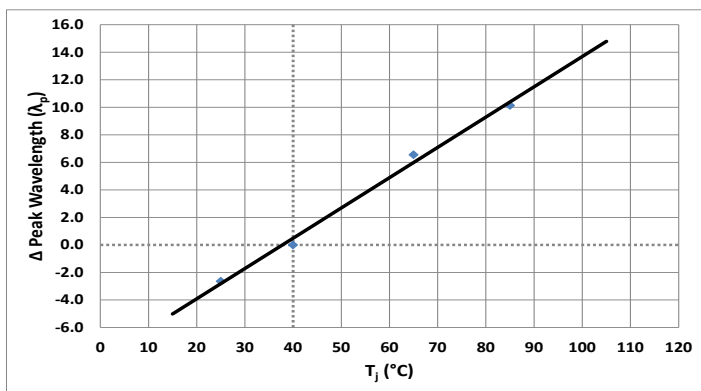

Typical Spectrum

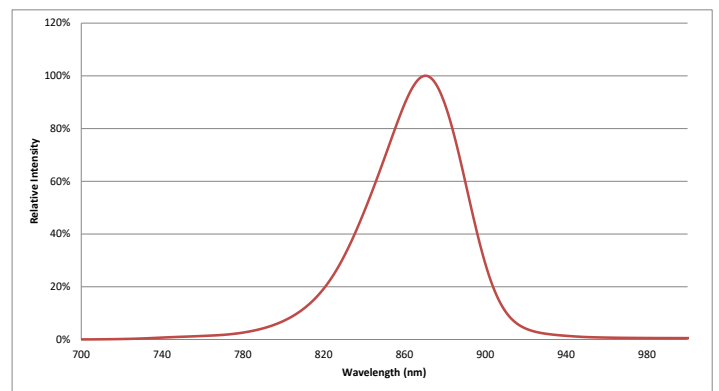

Mechanical Dimensions

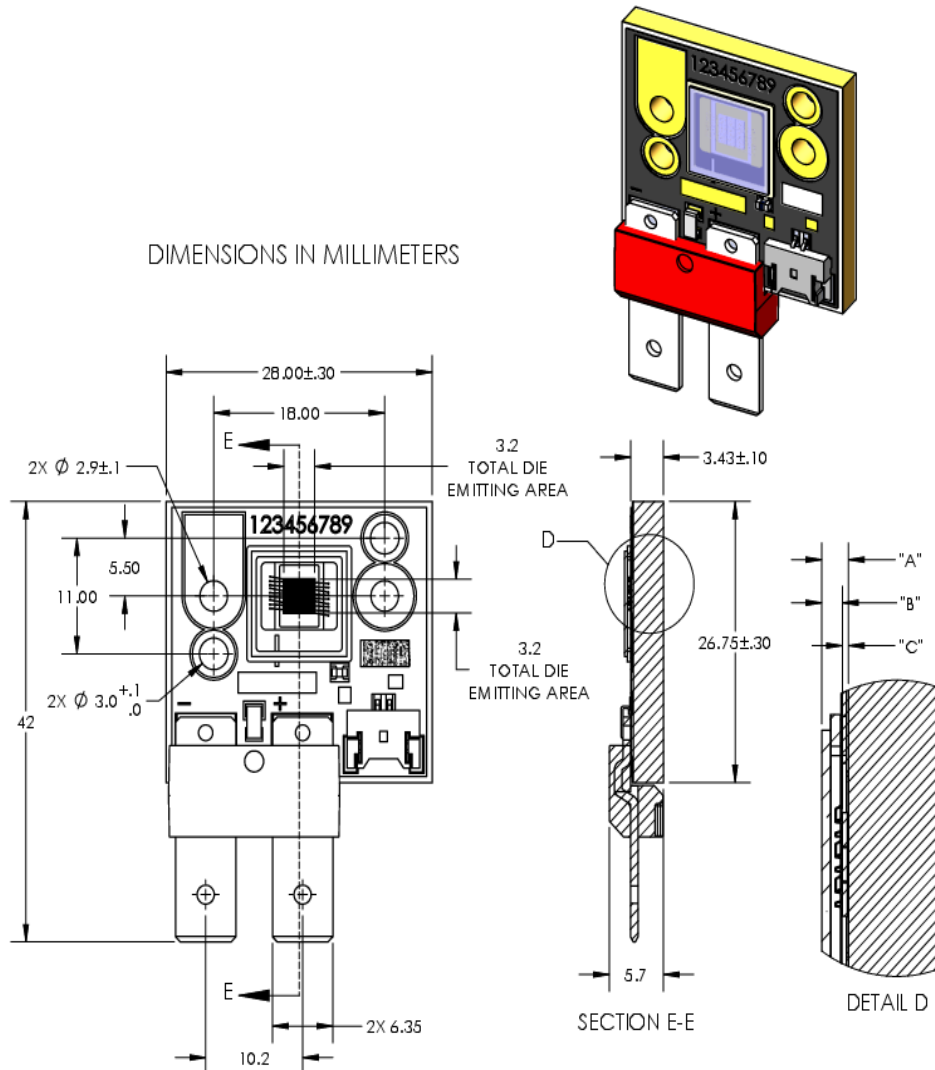

DWG-002978 REV01

Recommended connector for Anode and Cathode:

Panduit Disco Lok™ Series P/N: DNF14-250FIB-C or JST Manufacturing Co: SPS-61T-250 for AWG 16 to 14.

Panduit Disco Lok™ Series P/N: DNF10-250FIB-L or JST Manufacturing Co: SPS-91T-250 for AWG 12 to 10.

(Check NEC standards for ampacity of the power cable being used.)

Thermistor Connector: GCT P/N WTB08-021S-F.

Recommended Female: MOLEX P/N 51146-0200 (Not recommended for new designs), GCT P/N WTB06-020H-A or equivalent.

Shipping Tray Outline

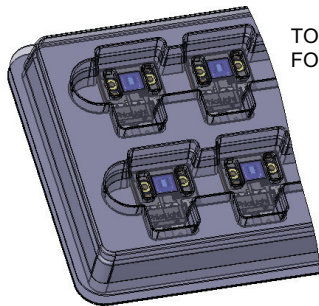
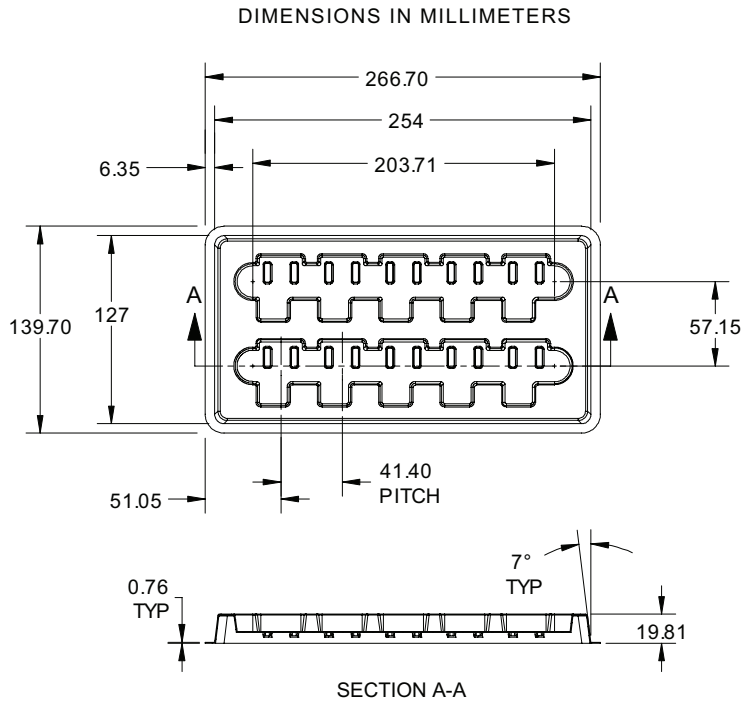

TOP TRAY SHOWN TRANSPARENT
FOR REFERENCE ONLY

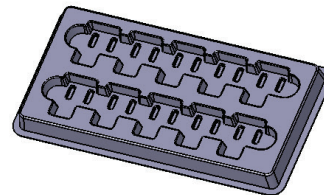

Packing and Shipping Specification (CBM-90-IRD)

Packing Specification

Packing Configuration	Qty /Pack	Reel Dimensions (diameter x W, mm)	Gross Weight (kg)
Stack of 5 trays with 10 devices per tray Each pack is enclosed in ESD bag	50	150 x 280 x 85	2.7

Product Label Specification

Label Fields (subject to change):

- 6-8 digit Box number (for Luminus internal use)
- Luminus ordering part number
- Quantity of devices in pack
- Part number revision (for Luminus internal use)
- Customer's part number (optional)
- Bin (FF-WW) as defined page 3
- 2D Bar code

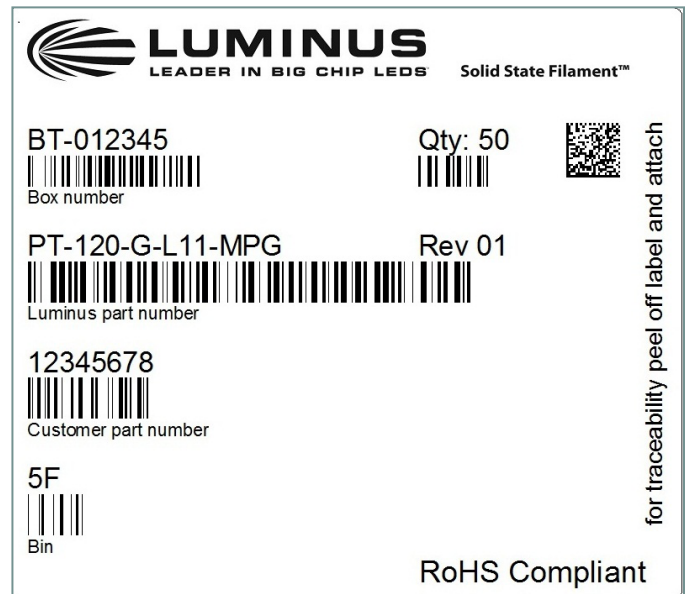

Sample label –for illustration only



Shipping Box

Shipping Box	Quantity	Material	Dimensions (L x W x H, mm)
Carton Box	1 -20 packs (50 - 1000 Devices)	S4651	560 x 560 x 200



History of Changes

Rev	Date	Description of Change
A	08/22/2019	Preliminary Release
01	03/04/2020	Initial Release to Production Updated thermal coefficient of radiometric power and typical FWHM on page 5 Updated graphs on page 7 Updated mechanical drawing on page 8
02	08/04/2020	Updated product picture on front page Updated temperature coefficient of radiometric power and thermal resistance on page 5 Updated mechanical drawing on page 8

The products, their specifications and other information appearing in this document are subject to change by Luminus Devices without notice. Luminus Devices assumes no liability for errors that may appear in this document, and no liability otherwise arising from the application or use of the product or information contained herein. None of the information provided herein should be considered to be a representation of the fitness or suitability of the product for any particular application or as any other form of warranty. Luminus Devices' product warranties are limited to only such warranties as accompany a purchase contract or purchase order for such products. Nothing herein is to be construed as constituting an additional warranty. No information contained in this publication may be considered as a waiver by Luminus Devices of any intellectual property rights that Luminus Devices may have in such information. Big Chip LEDs™ is a registered trademark of Luminus Devices, Inc., all rights reserved.

This product is protected by U.S. Patents 6,831,302; 7,074,631; 7,083,993; 7,084,434; 7,098,589; 7,105,861; 7,138,666; 7,166,870; 7,166,871; 7,170,100; 7,196,354; 7,211,831; 7,262,550; 7,274,043; 7,301,271; 7,341,880; 7,344,903; 7,345,416; 7,348,603; 7,388,233; 7,391,059 Patents Pending in the U.S. and other countries.