

**VECTRON**  
INTERNATIONAL

A  COMPANY

Product Data Sheet

## TC-350 Series Low Profile TCXO's Temperature Compensated Crystal Oscillators

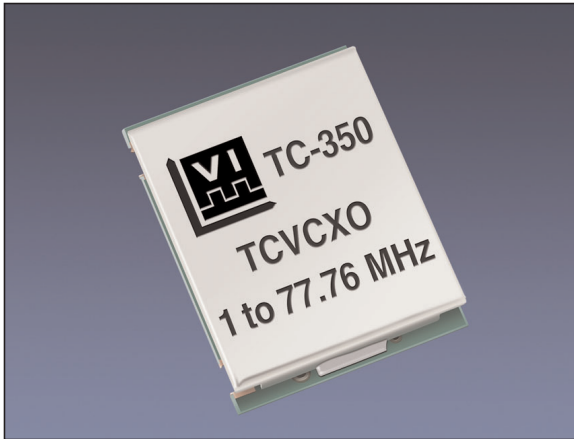

### Features

- Frequency from 1 to 77.76 MHz
- $\pm 1.0$  ppm,  $-40^{\circ}\text{C}$  to  $+85^{\circ}\text{C}$
- Low Profile: 3.81 mm (0.15") Ht.
- Aging  $< 5$  ppm for Ten Years
- 3.3 Vdc or 5 Vdc operation
- TTL/HCMOS Output

### Applications

- SMC Clock
- SONET/SDH Network Timing Sources
- Wireless Communications
- Satellite Communications
- Portable Test Equipment

### Description

Vectron International has introduced a series of low profile surface mount, Temperature Compensated Crystal Oscillators (TCXO's) available in frequencies from 1 to 77.76 MHz.

The TC-350 series surface mount TCXO can be mounted using the standard convection reflow process. Current drain to less than 5 mA is available upon request. Aging  $< 5$  ppm for ten years.

For additional information about TCXO's visit our website at:

**[www.tcxo.com](http://www.tcxo.com)**

# TC-350 Series Low Profile TCXO's

## Performance Characteristics

Parameter	Characteristics																															
<b>Standard Frequencies:</b>	10.00, 12.80, 13.00, 16.384, 19.44, 20.00, 20.48, 27.00 MHz Available from 1.0 MHz to 77.76 MHz																															
<b>Package:</b>	22.86 x 17.78 x 3.81 mm (0.90" x 0.70" x 0.15")																															
<b>Supply Voltage (Vdd):</b> (Other options are available upon request)	<b>C</b> = 5.0 Vdc ±5% <b>D</b> = 3.3 Vdc ±5%																															
<b>Current:</b>	Current draw will vary greatly depending on frequency and output type. For this series TCXO typical current draw will be about 10 mA. Please consult the factory about your exact current requirements.																															
<b>Output:</b>	<b>A</b> = HCMOS/ACMOS	<b>B</b> = 10 TTL																														
<b>Voh min.</b>	0.8 Vdd	2.4 Vdc																														
<b>Voh max.</b>	0.5 Vdc	0.5 Vdc																														
<b>Rise/Fall Time:</b>	5 ns max.	10 ns max.																														
<b>Symmetry (Duty Cycle):</b>	50% ±10%	50% ±10%																														
<b>Load:</b>	100k ohm // 10 pF	10 TTL																														
<b>Temperature Stability:</b>	<table border="0"> <tr> <td><b>B-507</b> = ±5.0 x 10<sup>-7</sup></td> <td>over</td> <td>0°C to +50°C</td> </tr> <tr> <td><b>B-106</b> = ±1.0 x 10<sup>-6</sup></td> <td>over</td> <td>0°C to +50°C</td> </tr> <tr> <td><b>C-507</b> = ±5.0 x 10<sup>-7</sup></td> <td>over</td> <td>0°C to +70°C</td> </tr> <tr> <td><b>C-106</b> = ±1.0 x 10<sup>-6</sup></td> <td>over</td> <td>0°C to +70°C</td> </tr> <tr> <td><b>D-757</b> = ±7.5 x 10<sup>-7</sup></td> <td>over</td> <td>-20°C to +70°C</td> </tr> <tr> <td><b>D-156</b> = ±1.5 x 10<sup>-6</sup></td> <td>over</td> <td>-20°C to +70°C</td> </tr> <tr> <td><b>F-106</b> = ±1.0 x 10<sup>-6</sup></td> <td>over</td> <td>-40°C to +85°C</td> </tr> <tr> <td><b>F-206</b> = ±2.0 x 10<sup>-6</sup></td> <td>over</td> <td>-40°C to +85°C</td> </tr> <tr> <td><b>G-156</b> = ±1.5 x 10<sup>-6</sup></td> <td>over</td> <td>-55°C to +85°C</td> </tr> <tr> <td><b>G-256</b> = ±2.5 x 10<sup>-6</sup></td> <td>over</td> <td>-55°C to +85°C</td> </tr> </table>		<b>B-507</b> = ±5.0 x 10 <sup>-7</sup>	over	0°C to +50°C	<b>B-106</b> = ±1.0 x 10 <sup>-6</sup>	over	0°C to +50°C	<b>C-507</b> = ±5.0 x 10 <sup>-7</sup>	over	0°C to +70°C	<b>C-106</b> = ±1.0 x 10 <sup>-6</sup>	over	0°C to +70°C	<b>D-757</b> = ±7.5 x 10 <sup>-7</sup>	over	-20°C to +70°C	<b>D-156</b> = ±1.5 x 10 <sup>-6</sup>	over	-20°C to +70°C	<b>F-106</b> = ±1.0 x 10 <sup>-6</sup>	over	-40°C to +85°C	<b>F-206</b> = ±2.0 x 10 <sup>-6</sup>	over	-40°C to +85°C	<b>G-156</b> = ±1.5 x 10 <sup>-6</sup>	over	-55°C to +85°C	<b>G-256</b> = ±2.5 x 10 <sup>-6</sup>	over	-55°C to +85°C
<b>B-507</b> = ±5.0 x 10 <sup>-7</sup>	over	0°C to +50°C																														
<b>B-106</b> = ±1.0 x 10 <sup>-6</sup>	over	0°C to +50°C																														
<b>C-507</b> = ±5.0 x 10 <sup>-7</sup>	over	0°C to +70°C																														
<b>C-106</b> = ±1.0 x 10 <sup>-6</sup>	over	0°C to +70°C																														
<b>D-757</b> = ±7.5 x 10 <sup>-7</sup>	over	-20°C to +70°C																														
<b>D-156</b> = ±1.5 x 10 <sup>-6</sup>	over	-20°C to +70°C																														
<b>F-106</b> = ±1.0 x 10 <sup>-6</sup>	over	-40°C to +85°C																														
<b>F-206</b> = ±2.0 x 10 <sup>-6</sup>	over	-40°C to +85°C																														
<b>G-156</b> = ±1.5 x 10 <sup>-6</sup>	over	-55°C to +85°C																														
<b>G-256</b> = ±2.5 x 10 <sup>-6</sup>	over	-55°C to +85°C																														
<b>Aging (typical):</b>	<5 ppm for ten years @ +70°C																															
<b>Frequency vs. Supply:</b>	<±0.1 ppm for a ±5% change in Supply Voltage																															
<b>Electrical Frequency Adjust:</b>	±5 ppm minimum via external voltage, 0 to Vdd																															

NOTE: Tighter stabilities and wider temperature ranges are available, please consult the factory.

# TC-350 Series Low Profile TCXO's

## Outline Drawing

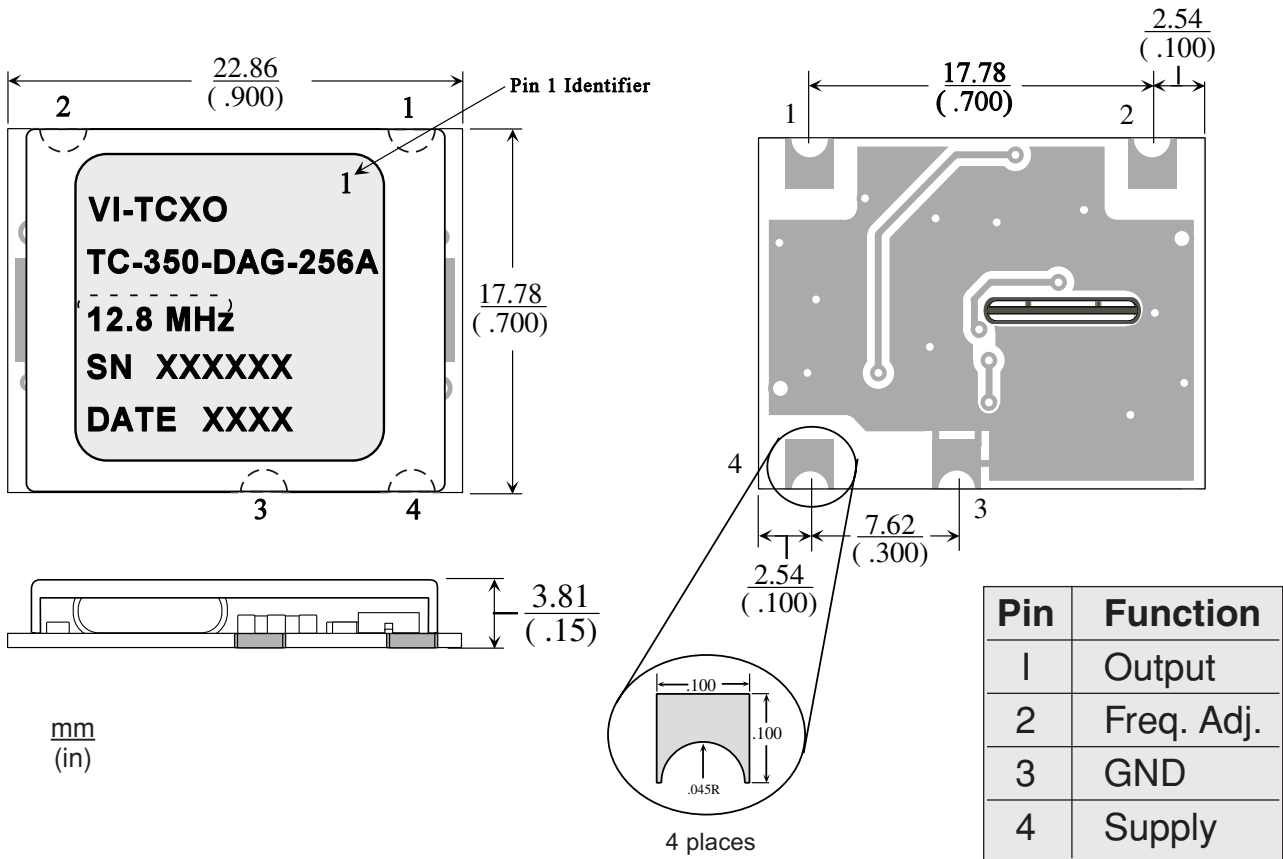

## Recommended Pad Layout

### Pad Layout for 350 Package

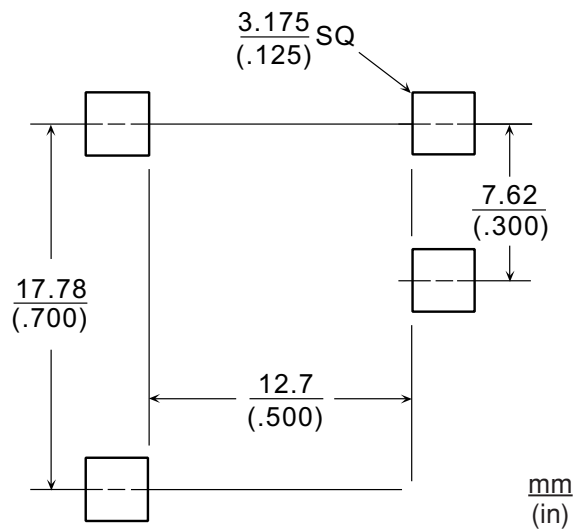

# TC-350 Series Low Profile TCXO's

## Recommended Reflow Profile

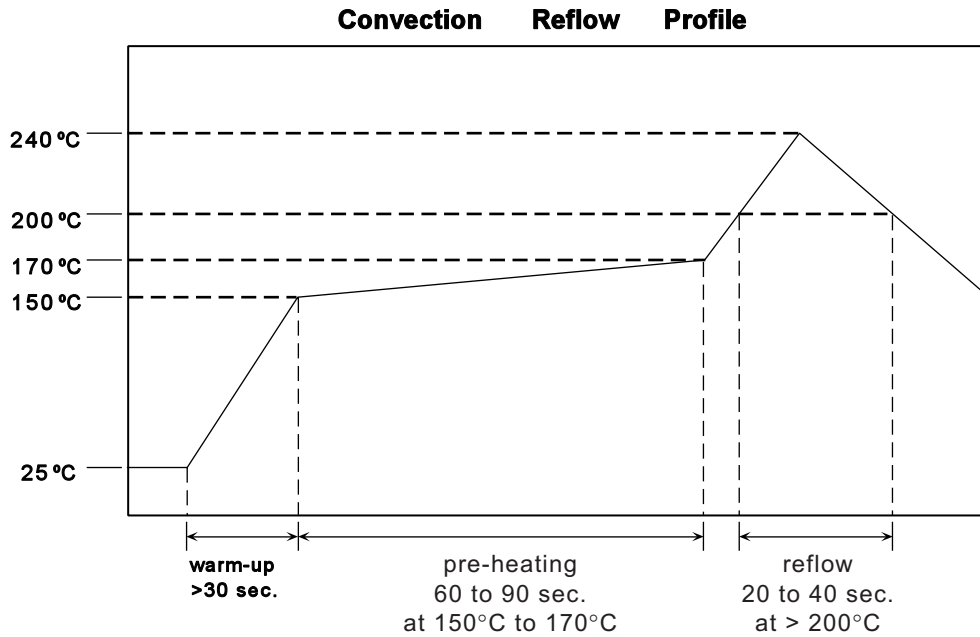

Note: TCXO's are precision subsystems with tolerances measured to 0.01 ppm. Non-Hermetically sealed TCXO's should not be subjected to a wash process that will immerse the TCXO in solvents. NO CLEAN is the recommended procedure. The TC-350 series of TCXO's has been designed for pick and place reflow soldering. The suggested reflow profile is shown above. The TCXO may be reflowed one time in the non-inverted state. Typical frequency shift as a result of reflow is <1.0 ppm per reflow. VI recommends waiting at least two hours after reflow before measuring the unit.

## Output Loads

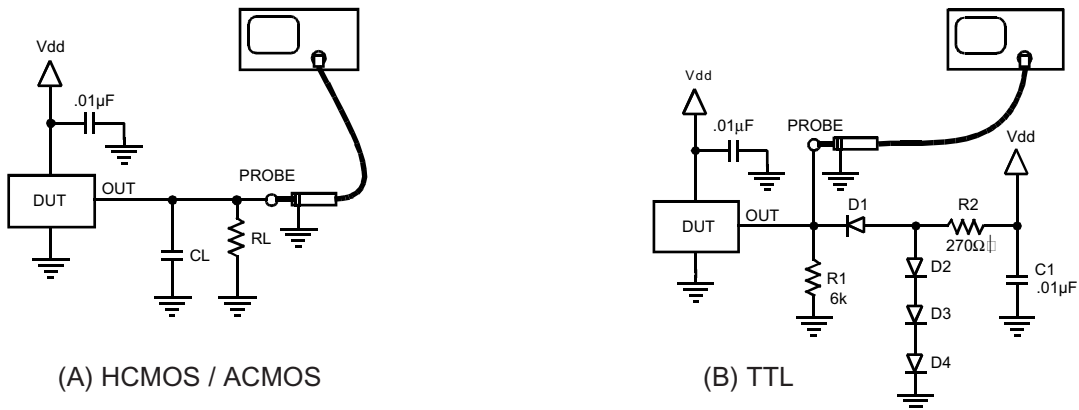

# TC-350 Series Low Profile TCXO's

## Standard Shipping Method

The Standard ship method for volume production of the TC-350 series is in a matrix tray. These trays are 100% recyclable. The trays also offer the added feature that they can be continuously feed into a pick-n-place machine eliminating the down time required with tape-n-reel.

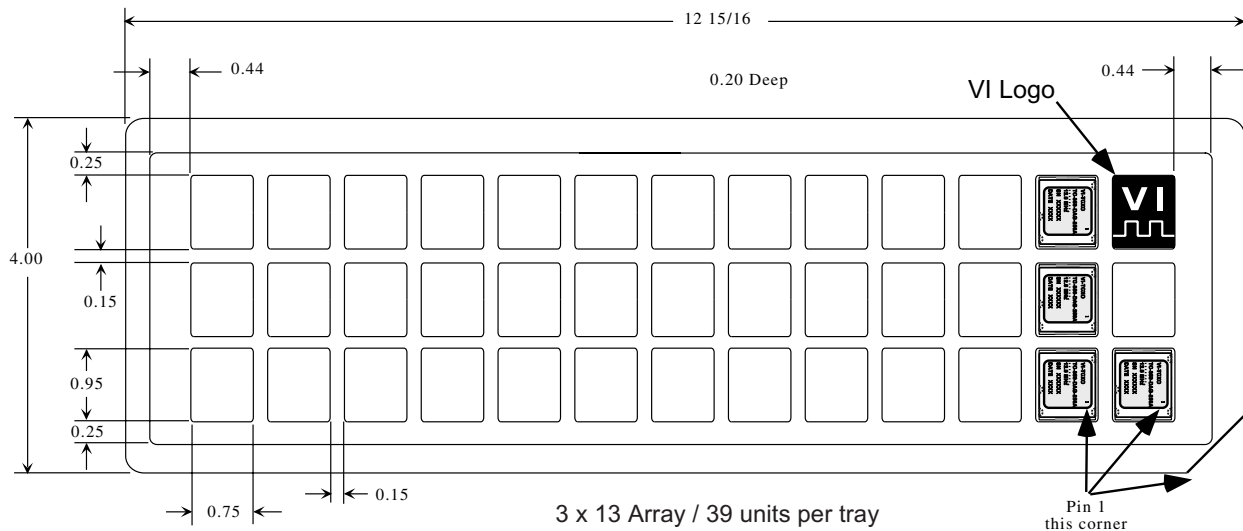

## Handling Precautions

Although protection circuitry has been designed into this device, proper precautions should be taken to avoid exposure to electrostatic discharge (ESD) during handling and mounting. VI employs a human-body model \*HBM) and a charged-device model (CDM) for ESD-susceptibility testing and protection design evaluation. ESD voltage thresholds are depending on the circuit parame-

ters used to define the mode.

Although no industry-wide standard has been adopted for the CDM, a standard HBM (resistance =1500 ohms, capacitance - 1000 pf) is widely used and therefore can be used for comparison purposes. The HBM ESD threshold presented here was obtained by using these circuit parameters.

ESD Threshold Voltage		
Model	Threshold	Unit
Human-Body (HBM)	500	V min
Charged-Device	500	V min

# TC-350 Series Low Profile TCXO's

## Ordering Information

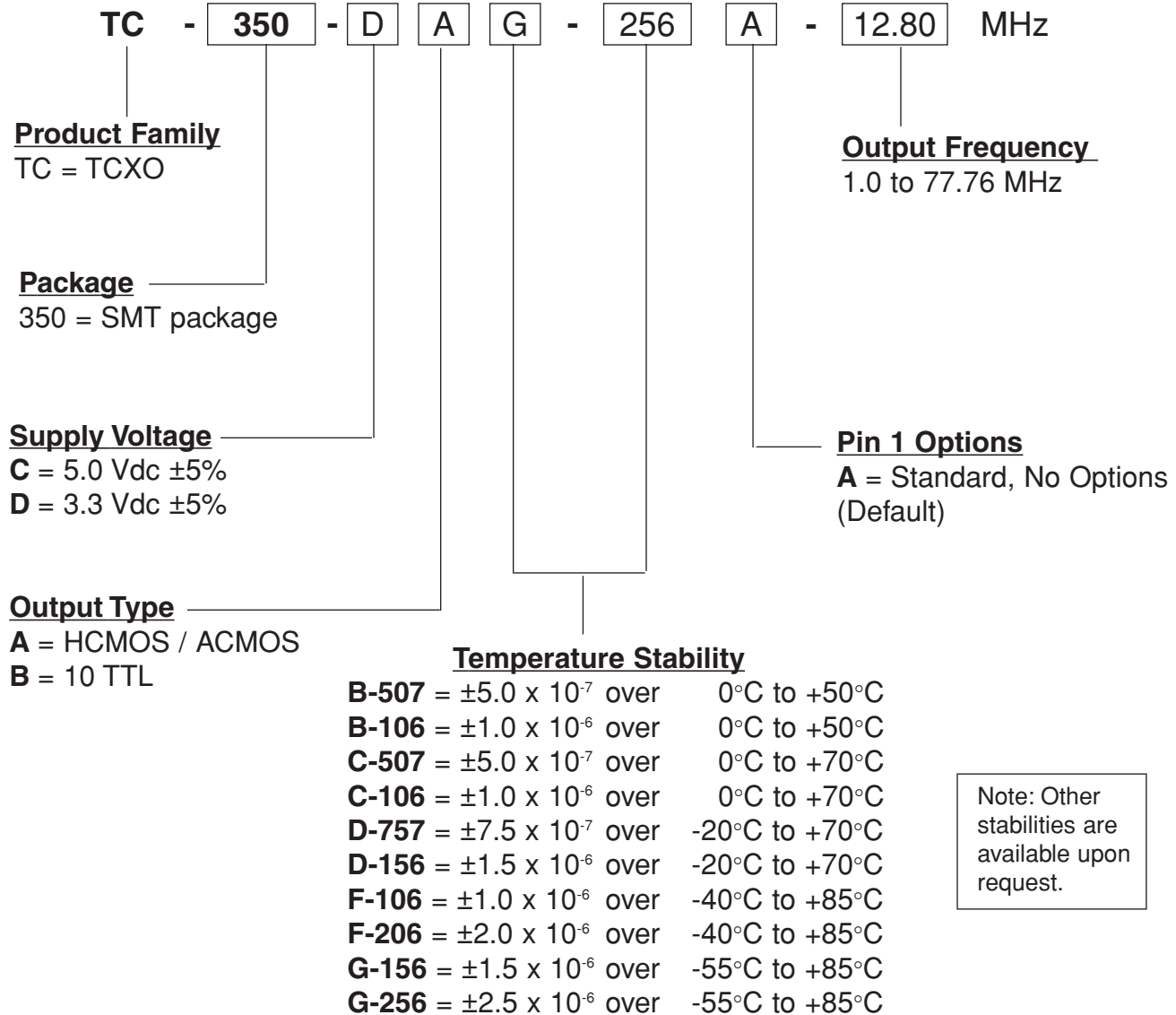

Visit our website at [www.vectron.com](http://www.vectron.com)

For additional information please contact:



USA: Vectron International • 267 Lowell Road, Hudson, NH 03051 . . . . . Tel: 1-888-VECTRON-1 • Fax: 1-888-FAX-VECTRON  
 EUROPE: . . . . . Tel: 49 (0) 3328 4784 17 Fax: 49 (0) 3328 4784 30  
 ASIA: . . . . . Tel: +86 21 28909740 / 41 /42 Fax: +86 21 28909240 / 2890999

[www.vectron.com](http://www.vectron.com)

Vectron International reserves the right to make changes to the product(s) and/or information contained herein without notice.  
 No liability is assumed as a result of their use or application. No rights under any patent accompany the sale of any such product(s) or information.

©2001, Vectron International.

Rev.04Jan02, 19Aug02