

## FEATURES



June 2010

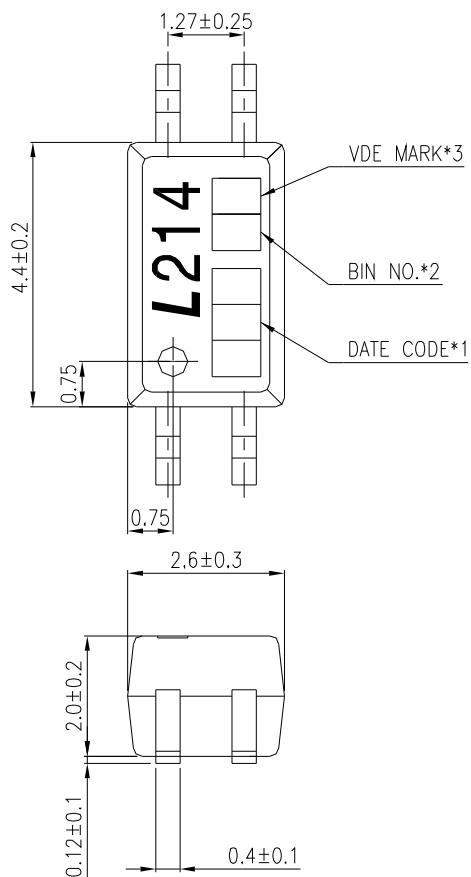
- \* Current transfer ratio  
( CTR : 80%~300% at  $I_F = \pm 1\text{mA}$ ,  $V_{CE} = 5\text{V}$  )
- \* Isolation voltage between input and output LTV-214 / 244  
( Viso = 3.75KVrms )
- \* Employs double transfer mold technology
  
- \* Safety Approval  
UL, CSA, FIMKO, VDE\* Approved  
(\*Requires "V" ordering option)
- \* RoHS compliance

## APPLICATIONS

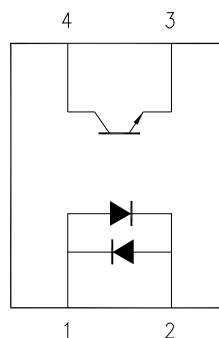
- \* Programmable controllers
- \* System appliances, measuring instruments

## OUTLINE DIMENSIONS

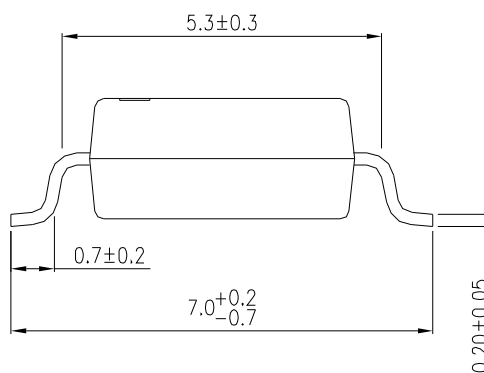
### LTV-214 :



Pin No. and Internal connection diagram



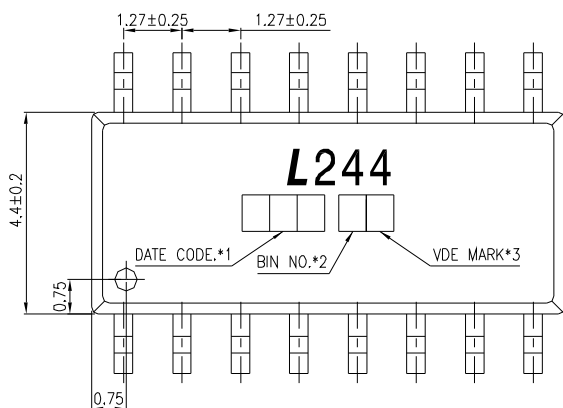
1. Anode, Cathode
2. Cathode, Anode
3. Emitter
4. Collector



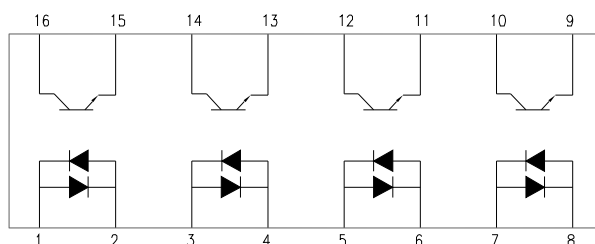
- \*1. 3-digit date code.
- \*2. Rank shall be or shall not be marked.
- \*3. VDE mark, only appears on devices ordered "V" option.

## OUTLINE DIMENSIONS

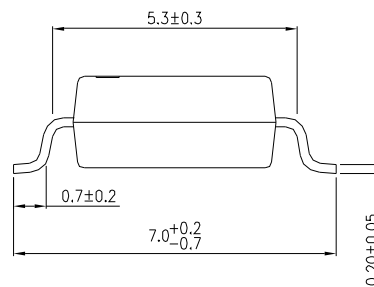
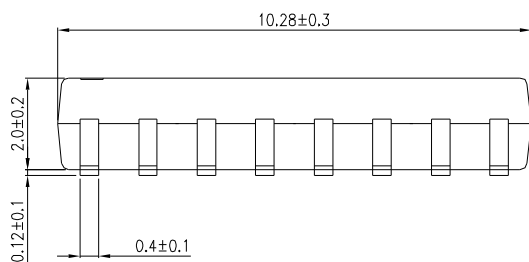
### LTV-244 :



### PIN NO. AND INTERNAL CONNECTION DIAGRAM



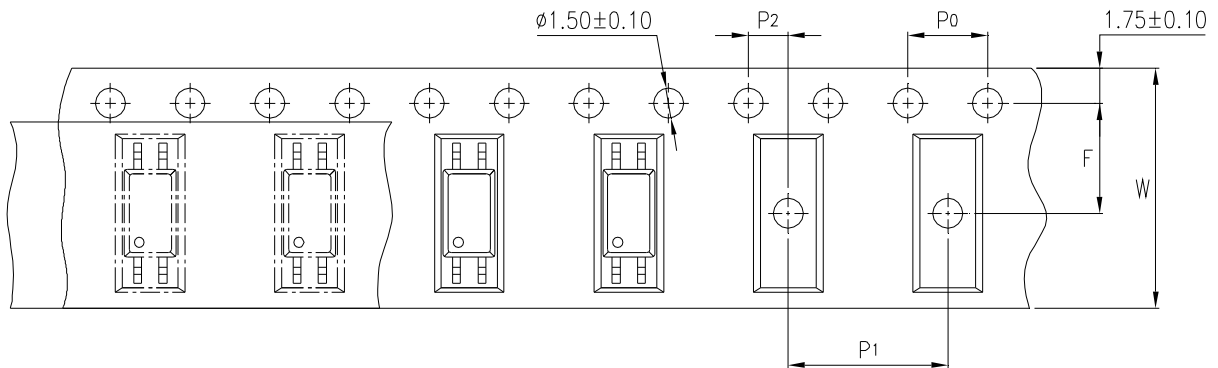
1,3,5,7. Anode,Cathode      9,11,13,15. Emitter  
2,4,6,8. Cathode,Anode      10,12,14,16. Collector



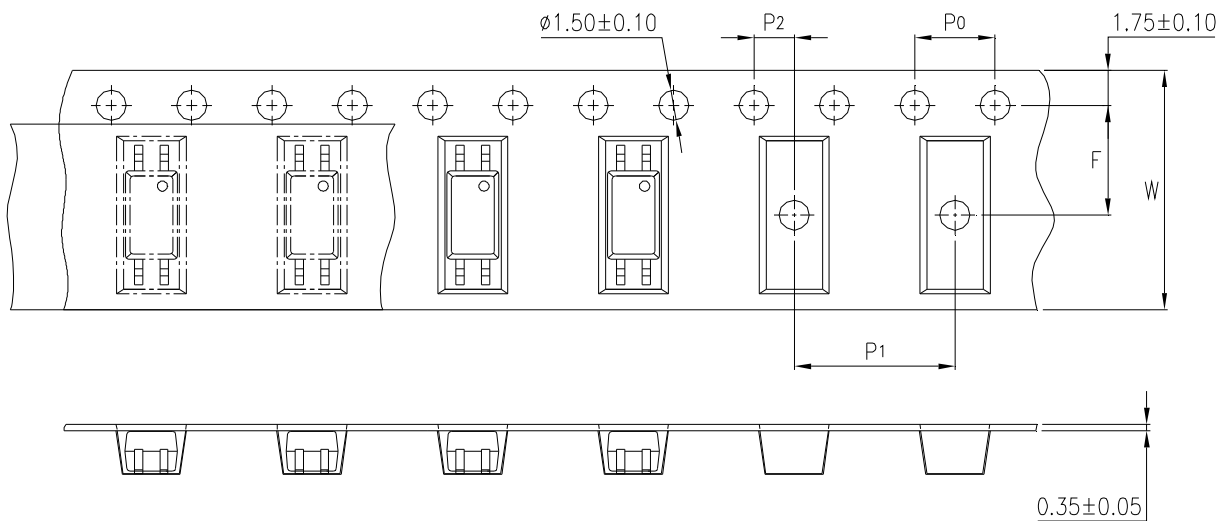
- \*1. 3-digit date code.
- \*2. Rank shall be or shall not be marked.
- \*3. VDE mark, only appears on devices ordered "V" option.

## TAPING DIMENSIONS

### LTV-214 series



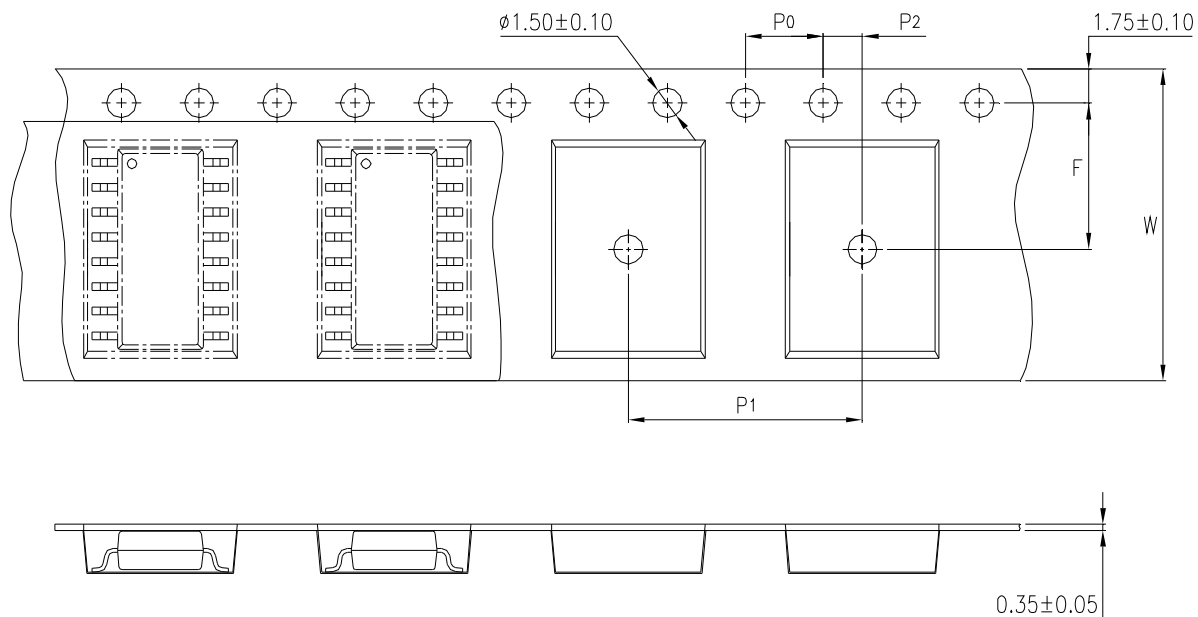
### LTV-214-TP1 series



Description	Symbol	Dimension in mm (inches)
Tape wide	W	12 ± 0.3 (.47)
Pitch of sprocket holes	P <sub>0</sub>	4 ± 0.1 (.15)
Distance of compartment	F P <sub>2</sub>	5.5 ± 0.1 (.217) 2 ± 0.1 (.079)
Distance of compartment to compartment	P <sub>1</sub>	8 ± 0.1 (.315)

## TAPING DIMENSIONS

### LTV-244 series



Description	Symbol	Dimension in mm (inches)
Tape wide	W	16 ± 0.3 (.47)
Pitch of sprocket holes	P <sub>0</sub>	4 ± 0.1 (.15)
Distance of compartment	F	7.5 ± 0.1 (.217)
	P <sub>2</sub>	2 ± 0.1 (.079)
Distance of compartment to compartment	P <sub>1</sub>	12 ± 0.1 (.63)

### Quantities per Reel :

Package Type	LTV-214	LTV-244
Quantities (pcs)	<b>3000</b>	<b>2000</b>

## ABSOLUTE MAXIMUM RATING

( Ta = 25°C )

PARAMETER		SYMBOL	RATING		UNIT
			214	244	
INPUT	Forward Current	$I_F$	50		mA
	Reverse Voltage	$V_R$	6		V
	Pulse Forward Current	$I_{FSM}$	1		A
	Power Dissipation	P	65		mW
OUTPUT	Collector - Emitter Voltage	$V_{CEO}$	80		V
	Emitter - Collector Voltage	$V_{ECO}$	7		V
	Collector Current	$I_C$	50		mA
	Collector Power Dissipation	$P_C$	150	100	mW
Total Power Dissipation		$P_{tot}$	200	170	mW
*1	Isolation Voltage	$V_{iso}$	3750		Vrms
Operating Temperature		$T_{opr}$	-55 ~ +110		°C
Storage Temperature		$T_{stg}$	-55 ~ +150		°C
*2	Soldering Temperature	$T_{sol}$	260 (10s)		°C

\*1. AC For 1 Minute, R.H. = 40 ~ 60%

Isolation voltage shall be measured using the following method.

- (1) Short between anode and cathode on the primary side and between collector and emitter on the secondary side.
- (2) The isolation voltage tester with zero-cross circuit shall be used.
- (3) The waveform of applied voltage shall be a sine wave.

\*2. For 10 Seconds

## ELECTRICAL - OPTICAL CHARACTERISTICS

( Ta = 25°C )

PARAMETER		SYMBOL	MIN.	TYP.	MAX.	UNIT	CONDITIONS
INPUT	Forward Voltage	V <sub>F</sub>	—	1.2	1.4	V	IF=±20mA
	Terminal Capacitance	C <sub>t</sub>	—	60	—	pF	V=0, f=1MHz
OUTPUT	Collector Dark Current	I <sub>CEO</sub>	—	—	100	nA	VCE=50V, IF=0
	Collector-Emitter Breakdown Voltage	BV <sub>CEO</sub>	80	—	—	V	IC=0.1mA IF=0mA
	Emitter-Collector Breakdown Voltage	BV <sub>ECO</sub>	7	—	—	V	IE=10 μA IF=0mA
TRANSFER CHARACTERISTICS	Collector Current	I <sub>C</sub>	0.8	—	3	mA	IF=±1mA VCE=5V
	*1 Current Transfer Ratio	CTR	80	—	300	%	
	Collector-Emitter Saturation Voltage	V <sub>CE(sat)</sub>	—	—	0.4	V	IF=±8mA IC=2.4mA
	Isolation Resistance	R <sub>iso</sub>	5×10 <sup>10</sup>	1×10 <sup>11</sup>	—	Ω	DC500V R.H.< 60%
	Floating Capacitance	C <sub>f</sub>	—	0.8	1	pF	V=0, f=1MHz
	Response Time (Rise)	t <sub>r</sub>	—	3	18	μs	VCE=2V, IC=±2mA RL=100Ω
	Response Time (Fall)	t <sub>f</sub>	—	4	18	μs	

$$*1 \text{ CTR} = \frac{I_C}{I_F} \times 100\%$$

## **RANK TABLE OF CURRENT TRANSFER RATIO CTR**

<b>MODEL NO.</b>	<b>RANK MARK</b>	<b>CTR ( % )</b>
LTV-214 / 244	DE	80 ~ 300

<b>CONDITIONS</b>	$I_F = \pm 1 \text{ mA}$ $V_{CE} = 5 \text{ V}$ $T_a = 25 \text{ }^\circ\text{C}$
-------------------	---



## CHARACTERISTICS CURVES

Figure 1. Collector Power Dissipation vs. Ambient Temperature

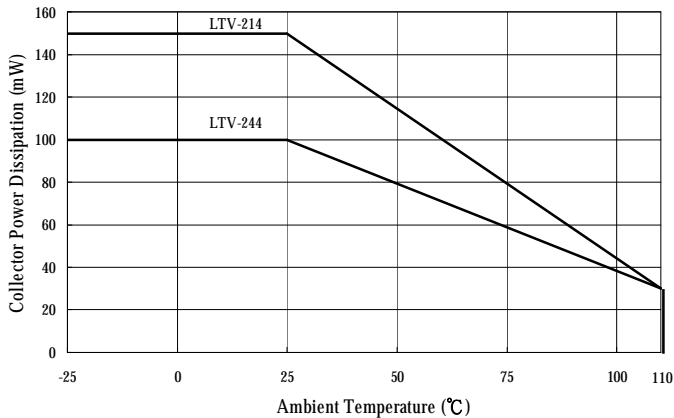


Figure 2. Forward Current vs. Ambient Temperature

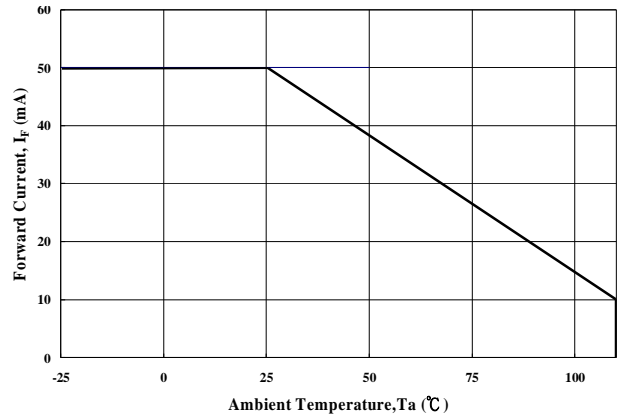


Figure 3. Forward Current vs. Forward Voltage

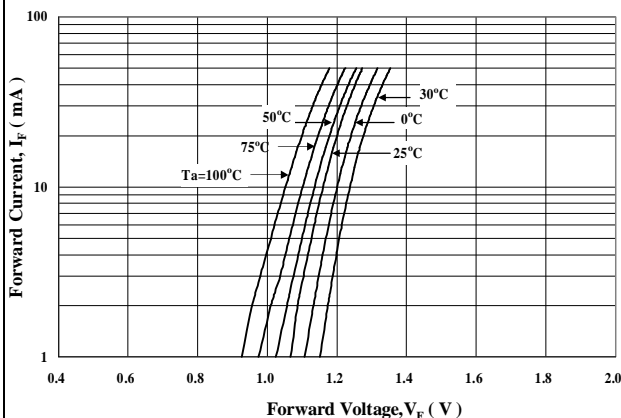


Figure 4. Forward Voltage Temperature Coefficient vs. Forward Current

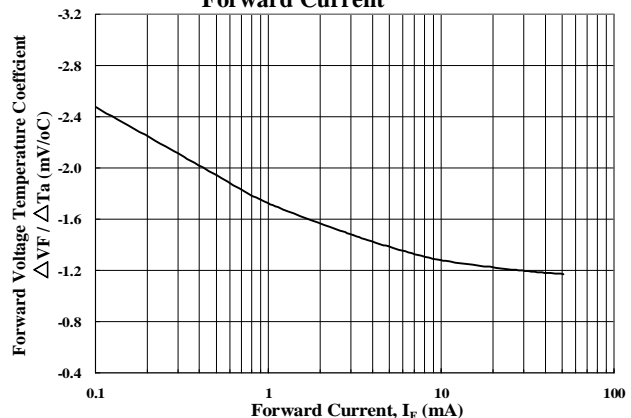


Figure 5. Pulse Forward Current vs. Duty Cycle Ratio

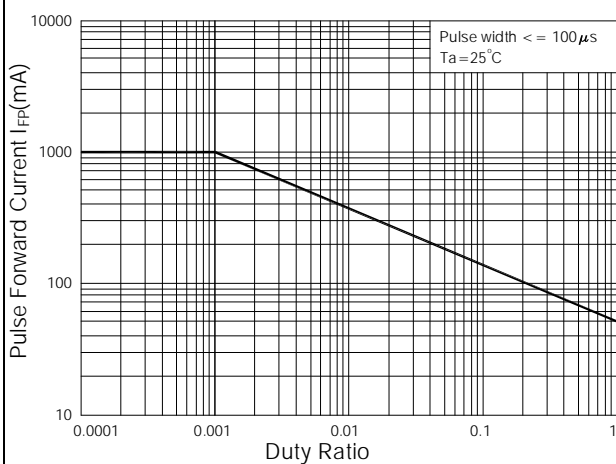
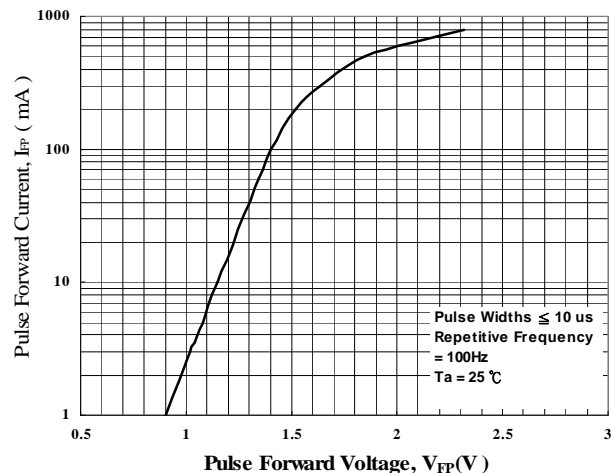
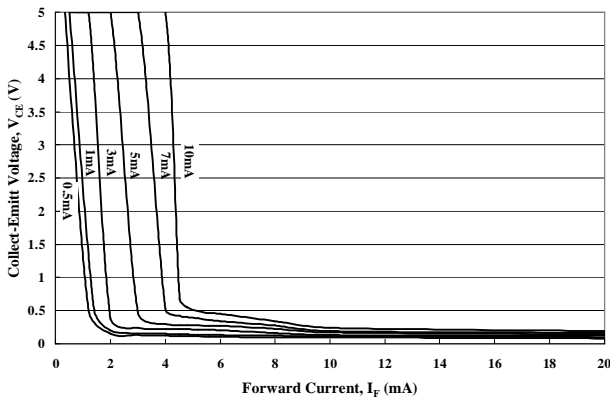


Figure 6. Pulse Forward Current vs. Pulse Forward Voltage

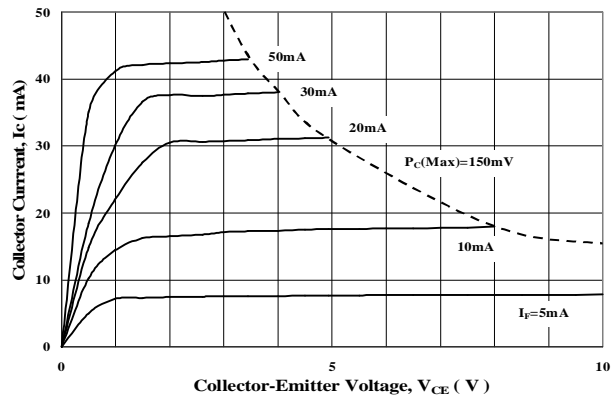


## CHARACTERISTICS CURVES

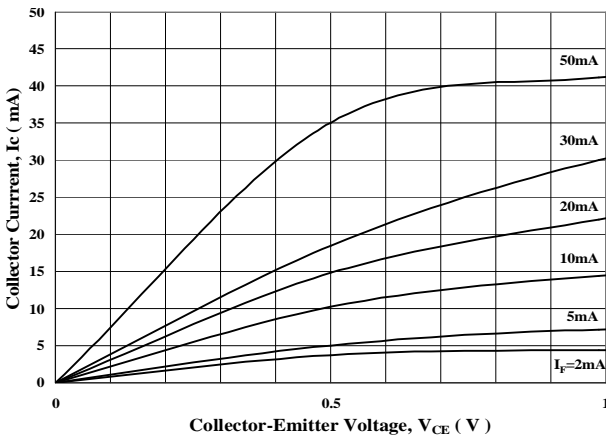
**Figure 7. Collector-Emitt Saturation Voltage vs. Forward Current**



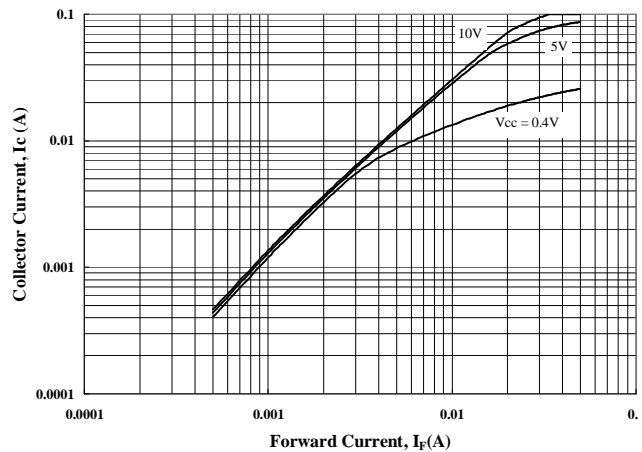
**Figure 8. Collector Current vs. Collector-Emitt Voltage**



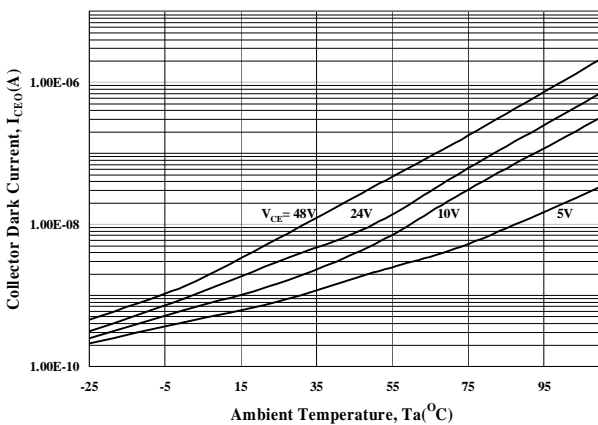
**Figure 9. Collector Current vs. Small Collector-Emitt Voltage**



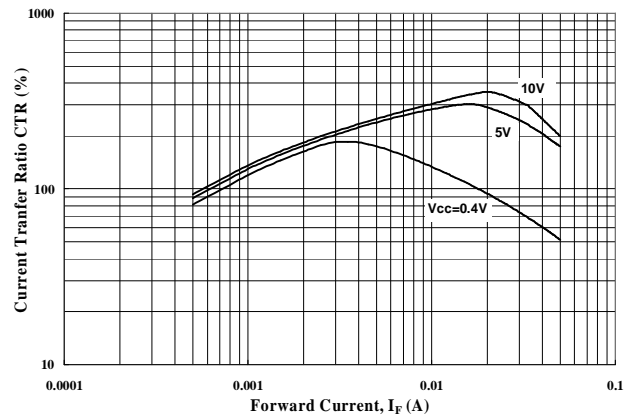
**Figure 10. Collector Current vs. Forward Current**



**Figure 11. Collector Dark Current vs. Ambient Temperature**

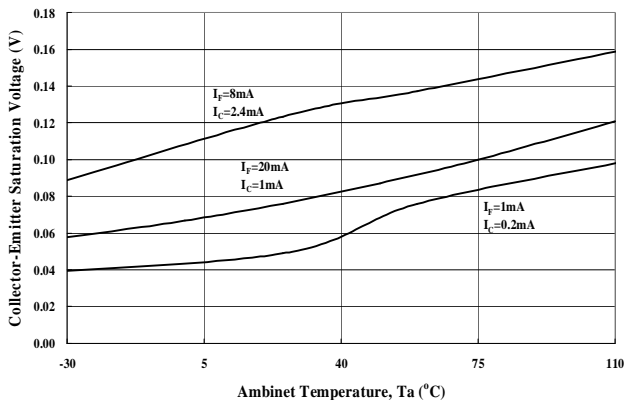


**Figure 12. Current Transfer Ratio vs. Forward Current**

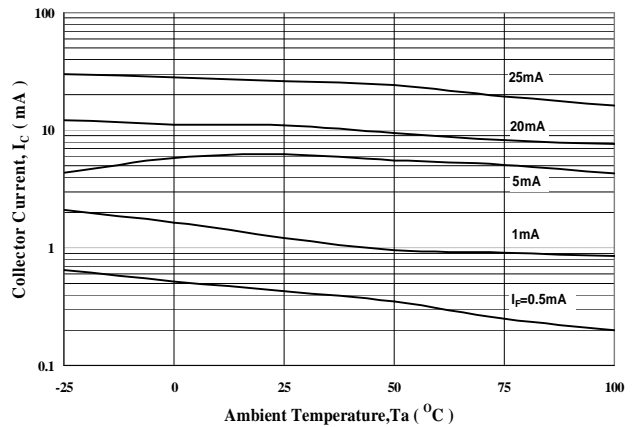


## CHARACTERISTICS CURVES

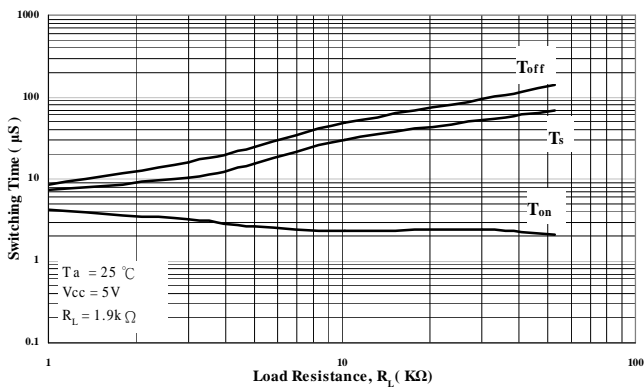
**Figure 13. Collector-Emitter Saturation Voltage vs. Ambient Temperature**



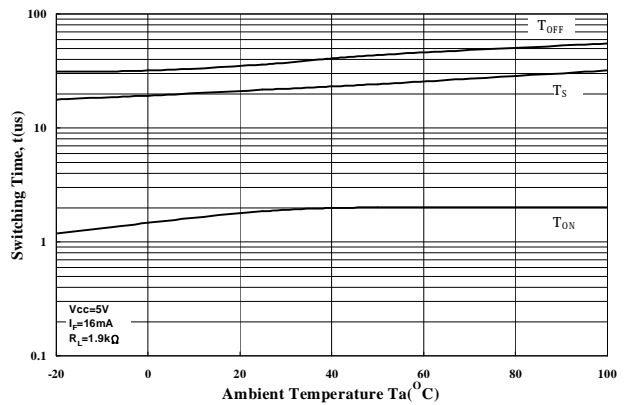
**Figure 14. Collector Current vs. Ambient Temperature**



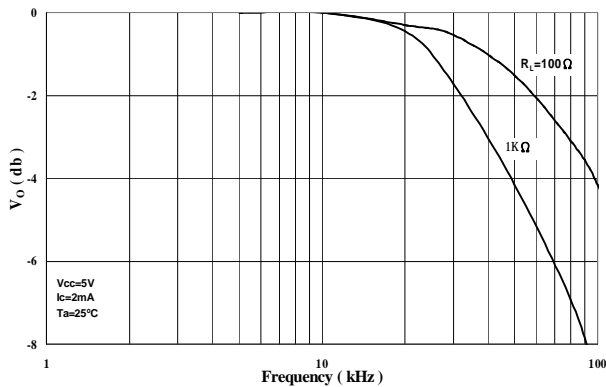
**Figure 15. Switching Time vs. Load Resistance**



**Figure 16. Switching Time vs. Ambient Temperature**

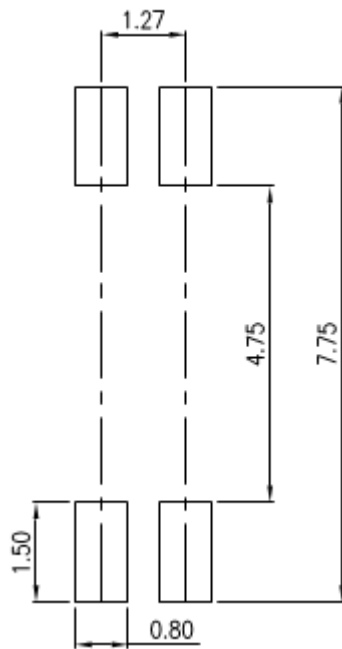


**Figure 17. Frequency Response**

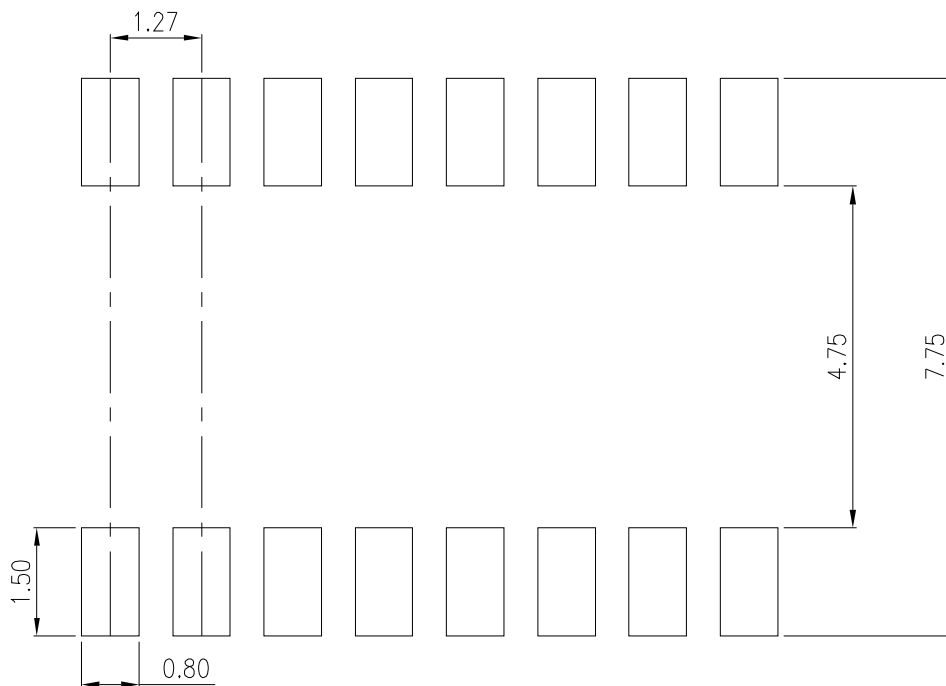


## RRECOMMENDED FOOT PRINT PATTERNS (MOUNT PAD)

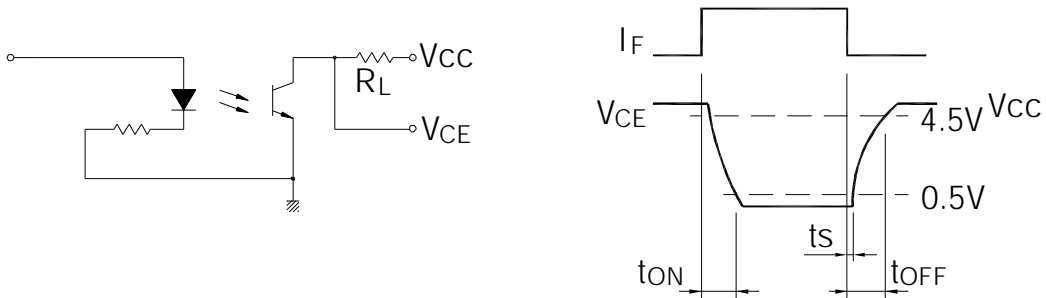
LTV-214



LTV-244



## SWITCHING TIME TEST CIRCUIT



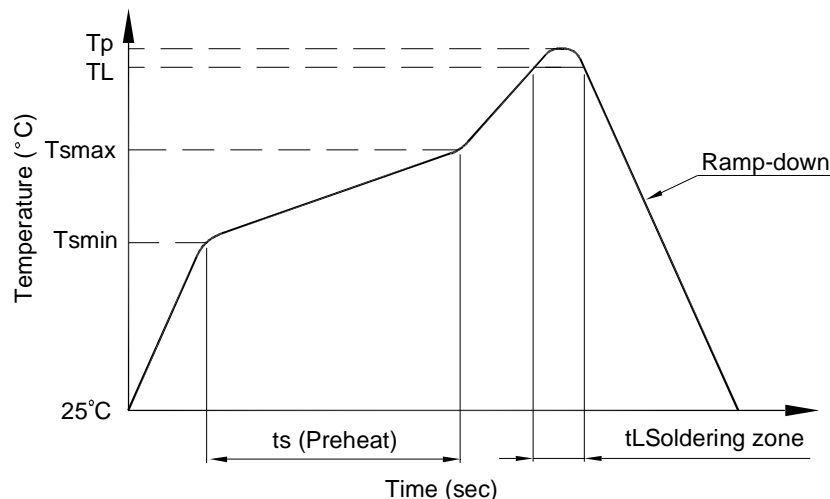
## TEMPERATURE PROFILE OF SOLDERING REFLOW

(1) One time soldering reflow is recommended within the condition of temperature and time profile shown below.

1. Wave solder
  - 260°C / 10 sec.

2. IR Reflow

Profile item	Conditions
Preheat	
- Temperature Min ( $T_{Smin}$ )	150°C
- Temperature Max ( $T_{Smax}$ )	180°C
- Time (min to max) (ts)	90±30°C
Soldering zone	
- Temperature ( $T_L$ )	250°C
- Time ( $t_L$ )	10~15 sec
Peak Temperature ( $T_P$ )	260°C
Ramp-down rate	3~6°C / sec



## **TEMPERATURE PROFILE OF SOLDERING REFLOW**

(2) When using another soldering method such as infrared ray lamp, the temperature may rise partially in the mold of the device.

Keep the temperature on the package of the device within the condition of above (1)

### **Notes:**

- Lite-On is continually improving the quality, reliability, function or design and Lite-On reserves the right to make changes without further notices.
- The products shown in this publication are designed for the general use in electronic applications such as office automation equipment, communications devices, audio/visual equipment, electrical application and instrumentation.
- For equipment/devices where high reliability or safety is required, such as space applications, nuclear power control equipment, medical equipment, etc, please contact our sales representatives.
- When requiring a device for any "specific" application, please contact our sales in advice.
- If there are any questions about the contents of this publication, please contact us at your convenience.
- The contents described herein are subject to change without prior notice.
- Do not immerse unit's body in solder paste.