

1.6 GHz Low Noise Amplifier

■ GENERAL DESCRIPTION

The XC2401A8167R-G is an ultra-low-noise amplifier (LNA) with low operating voltage, low noise figure (NF), low power consumption using CMOS process.

The device offers easy output matching to $50\ \Omega$ for input and output with less external components.

An internal self bias function eliminates external bias setting.

The device operates at 1.2V. For higher power supplies such as 1.8V and 2.85V, the device can operate with a self bias of one adding resistor.

■ APPLICATIONS

- GPS RF module

■ FEATURES

Noise Figure	: NF=0.69dB(TYP.) (@ 1.575GHz)
Low Power Consumption	: 6.6mW (TYP.) @ $V_{DD}=1.2V$, Fixed Bias
High Gain	: $S_{21} = 15dB$ (TYP.) (@ 1.575GHz)
Operation Voltage Range	: 1.14V~1.26V @ Fixed Bias
Output	: CMOS Output, $50\ \Omega$ driver built-in
Operating Ambient Temperature	: $-40^{\circ}C \sim +85^{\circ}C$
Package	: USPN-4B02
Environmentally Friendly	: EU RoHS Compliant, Pb Free

■ TYPICAL APPLICATION CIRCUIT

Figure 1: Fixed Bias

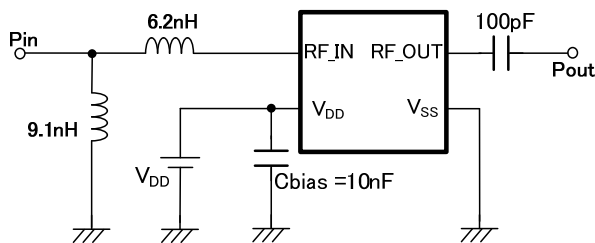
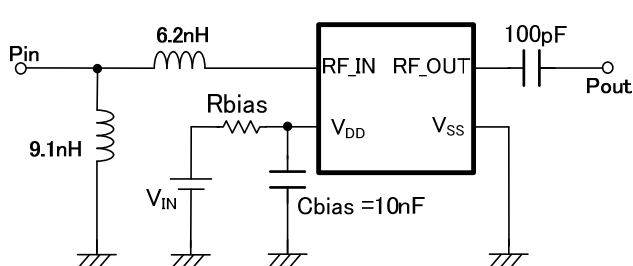

Figure 2: Self Bias



V_{IN} [V]	R_{bias} [Ω]
3.00	560
2.85	470
1.80	160

* R_{BIAS} should be in $\pm 1\%$ tolerance and $\pm 200ppm/^{\circ}C$ temperature stability.

■ TYPICAL PERFORMANCE CHARACTERISTICS

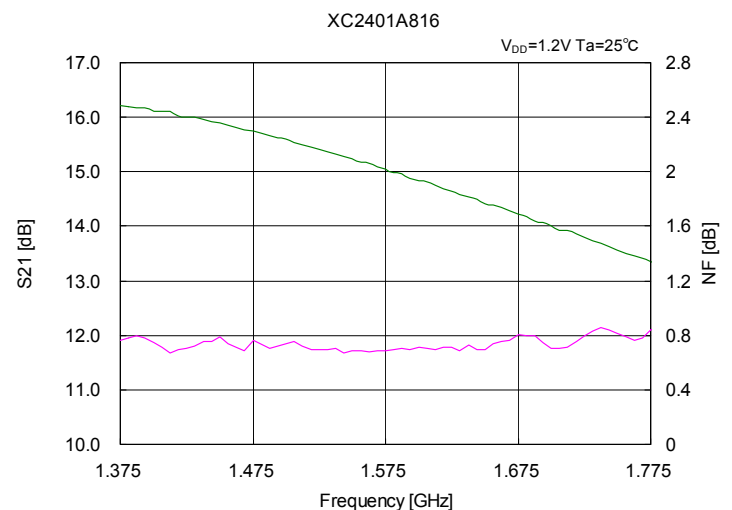

■ PIN CONFIGURATION

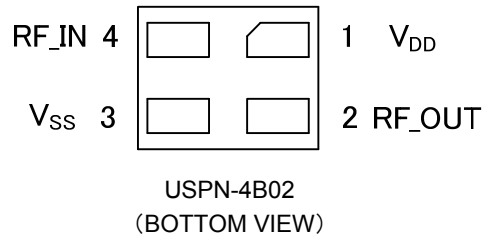

■ PIN ASSIGNMENT

PIN NUMBER USPN-4B02	PIN NAME	FUNCTION
1	V _{DD}	Power Supply RF
2	RF_OUT	RF Signal Output
3	V _{SS}	Ground
4	RF_IN	RF Signal Input

■ PRODUCT CLASSIFICATION

● Ordering Information

PRODUCT NAME	PACKAGE	ORDER UNIT
XC2401A8167R-G ^(*)	USPN-4B02	5,000/Reel

^(*) The "-G" suffix denotes Halogen and Antimony free as well as being fully RoHS compliant.

■ BLOCK DIAGRAM

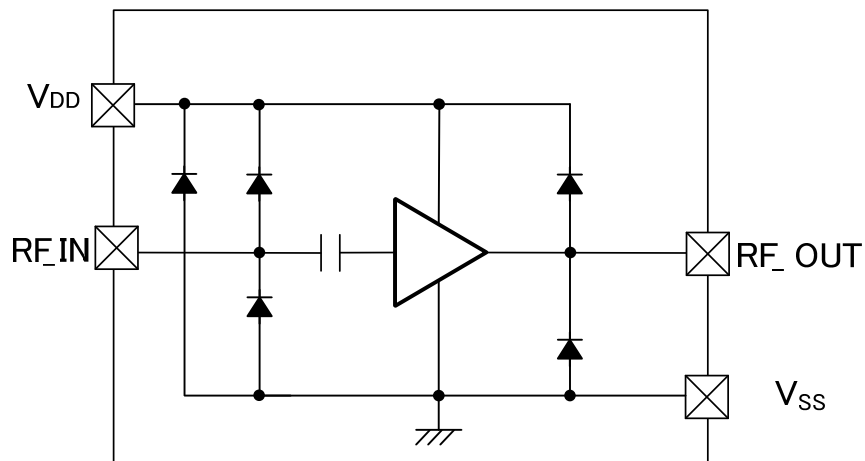

■ ABSOLUTE MAXIMUM RATINGS

Ta=25°C

PARAMETER	SYMBOL	RATINGS	UNITS
Supply Voltage	V _{DD}	V _{SS} - 0.3 ~ 1.60	V
Supply Current	I _{DD}	30	mA
RF Input Power	P _{IN}	10	dBm
RF_IN Input Voltage	RF_IN	V _{SS} - 0.3 ~ V _{DD} + 0.3	V
RF_OUT Input Voltage	RF_OUT	V _{SS} - 0.3 ~ V _{DD} + 0.3	V
Power Dissipation	P _d	100	mW
Operating Ambient Temperature	T _{opr}	-40 ~ +85	°C
Storage Temperature	T _{stg}	-55 ~ +125	°C

ELECTRICAL CHARACTERISTICS

●DC Characteristics

Fixed Bias (refer to TYPICAL APPLICATION CIRCUIT, Figure 1)

Ta=25°C

PARAMETER	SYMBOL	CONDITIONS	MIN.	TYP.	MAX.	UNITS	CIRCUIT
Power Supply Pin Voltage	V _{DD}	-	1.14	1.20	1.26	V	①
Current Circuit	I _{DD}	V _{DD} =1.2V		5.5	10.5	mA	①

Self Bias (refer to TYPICAL APPLICATION CIRCUIT, Figure 2)

PARAMETER	SYMBOL	CONDITIONS	MIN.	TYP.	MAX.	UNITS	CIRCUIT
Input Power Supply Voltage 1	V _{IN1}	R _{bias} =560 Ω ± 1% ± 200ppm/°C	2.850	3.000	3.150	V	①
Input Power Supply Voltage 2	V _{IN2}	R _{bias} =470 Ω ± 1%, ± 200ppm/°C	2.708	2.850	2.992	V	①
Input Power Supply Voltage 3	V _{IN3}	R _{bias} =160 Ω ± 1%, ± 200ppm/°C	1.710	1.800	1.890	V	①
Power Supply Pin Voltage	V _{DD}	V _{IN} = V _{IN1} , V _{IN2} , V _{IN3}	0.90	1.12	1.32	V	①
Current Circuit	I _{DD}	V _{IN} = V _{IN1} , V _{IN2} , V _{IN3}	-	4.25	5.50	mA	①

* When the device is used in self bias, please use the specified R_{BIAS} and C_{BIAS}.

■ ELECTRICAL CHARACTERISTICS (Continued)

● AC Characteristics

 $V_{DD}=1.2V$ $T_a=25^{\circ}C$

PARAMETER	SYMBOL	CONDITIONS	MIN.	TYP.	MAX.	UNITS	CIRCUIT
Power Gain	S21	f=1.575 GHz	11.5	15.0	-	dB	②
Input Return Loss	S11	f=1.575GHz	-	6	-	dB	②
Output Return Loss	S22	f=1.575GHz	-	6	-	dB	②
Isolation	S12	f=1.575GHz	-	-20	-	dB	②
Noise Figure ^(*1)	NF	f=1.575GHz	-	0.69	-	dB	③
Input Power IP3	I _{IP3}	f=1.575GHz, 1.576GHz Pin = -30dBm	-	-1.0	-	dBm	④
Input Power @ 1dB Gain Compression	P1dB	f=1.575GHz	-	-12	-	dBm	②

*1: NF is the value excluding the PCB loss.

Note

- In case symptoms of transient voltage drop and rise temporarily, please use this IC within the stated maximum ratings.
The IC is liable to malfunction should the ratings be exceeded.
- Please eliminate static electricity from the operational table, people, and soldering iron.
- Please use noiseless power supply for stable operation.
- Please use $\pm 1\%$ Rbias with $\pm 200\text{ppm}/^{\circ}C$ temperature stability and 10nF Cbias.
- Please connect Cbias to V_{DD} pin as close as possible.
- Please ensure to use an external component which does not depend on bias or temperature too much.
- We will improve the product quality and improve reliability, however please make sure to design fail safe or pre-aging treatment on the system.

TEST CIRCUITS

- Circuit ① (DC Characteristics: Power Supply Pin Voltage, Circuit Current, Input Power Supply Voltage)

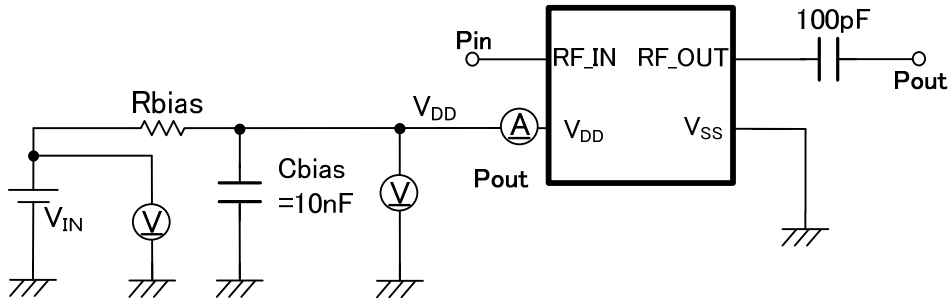

- * Fixed Bias: $R_{bias}=0\Omega$, $V_{IN}=V_{DD}$
- ** Pin / Pout is 50Ω

- Circuit ② (Power Gain, Input Return Loss, Output Return Loss, Isolation, Input Power @ 1dB Gain Compression)

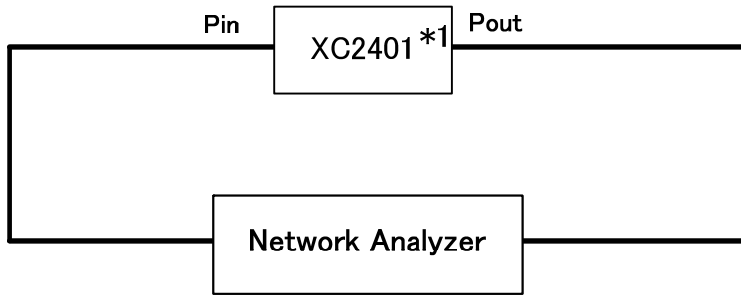

*1: Refer to the circuit ⑤ for the block detail.

- Circuit ③ (Noise Figure)

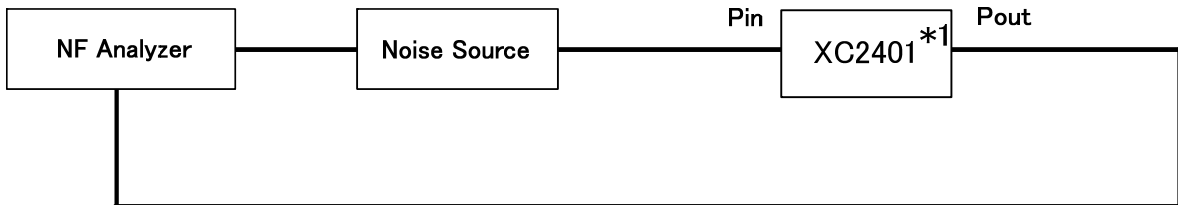

*1: Refer to the circuit ⑤ for the block detail.

■ TEST CIRCUITS (Continued)

● Circuit ④ (Input Power IP3)

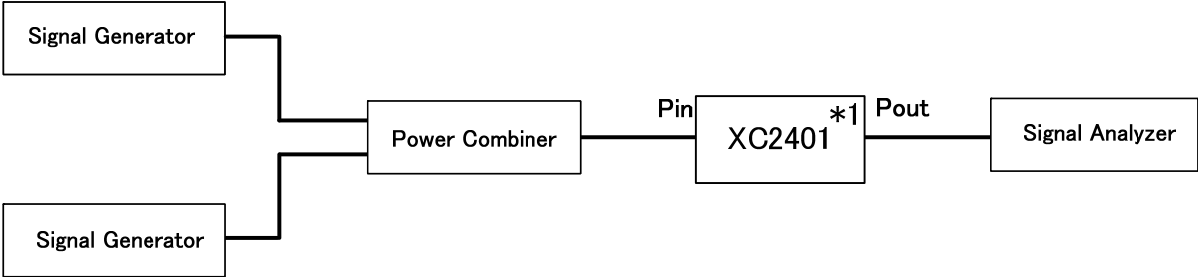

*1: Refer to the circuit ⑤ for the block detail.

● Circuit ⑤ (XC2401 series, the circuit of the block)

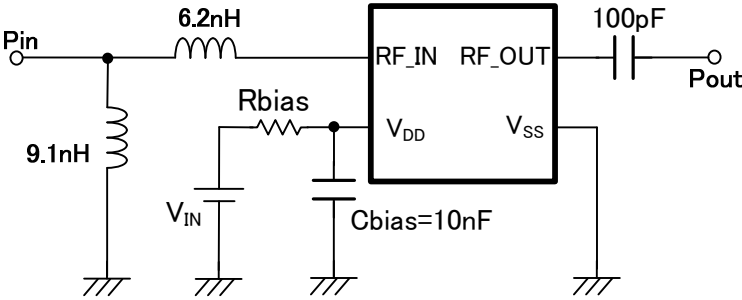

V _{IN} (V)	R _{bias} (Ω)
3.00	560
2.85	470
1.80	160

- * Fixed Bias: R_{bias}=0Ω, V_{IN}=V_{DD}
- ** R_{bias}: Should be in ±1% tolerance and ±200ppm/°C temperature stability.

EVALUATION BOARD

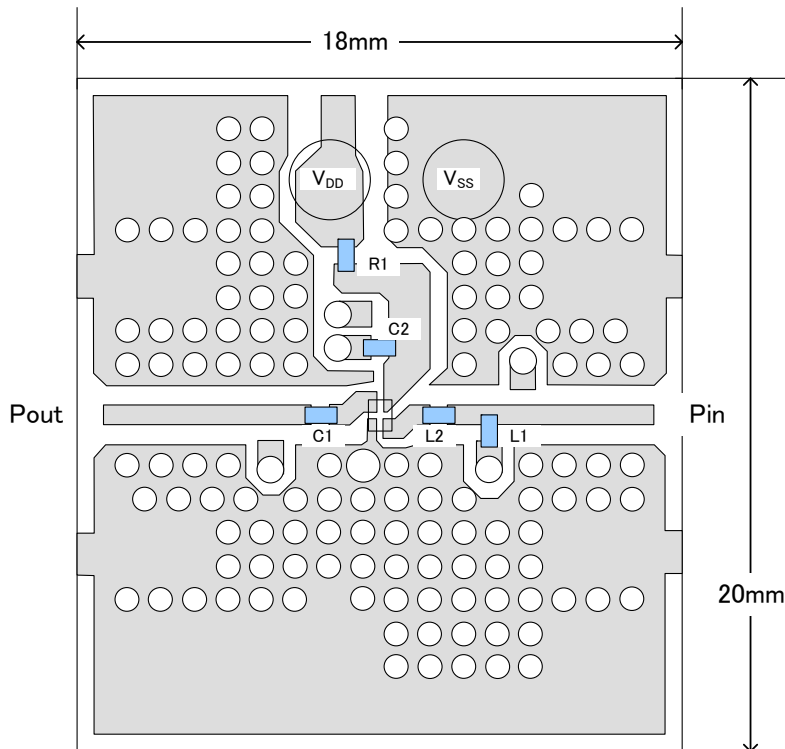

SYMBOL	SPEC	COMMENT
C1	100pF	MURATA (GRM1552C1H)
C2	10nF	-
L1	9.1nH	TDK (GLQ1005type)
L2	6.2nH	TDK (GLQ1005type)
R1 (Rbias) ^(*)	- ^(*)	Less than $\pm 1\%$ tolerance, Less than $\pm 200\text{ppm}/^\circ\text{C}$ temperature stability

PCB(FR-4)
 MICROSTRIPLINE WIDTH = 0.6mm
 t = 0.018mm
 PCB size = 20mm × 18mm

*1: Fixed Bias: Rbias=0Ω

* Please use an external component which does not depend on bias or temperature too much.

■ TYPICAL PERFORMANCE CHARACTERISTICS

(1) Supply Current vs. Supply Voltage

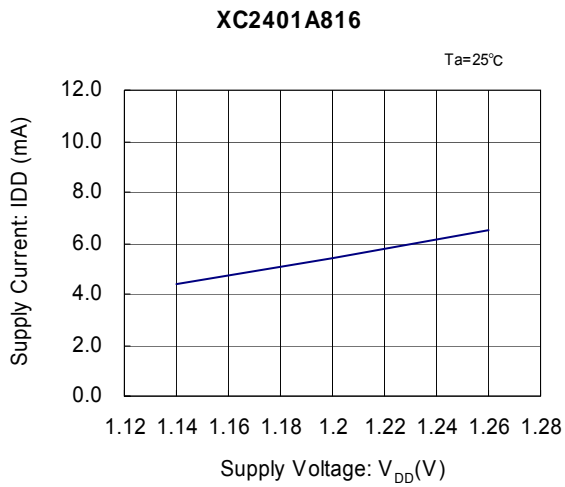

(2) Power Gain vs. Supply Voltage

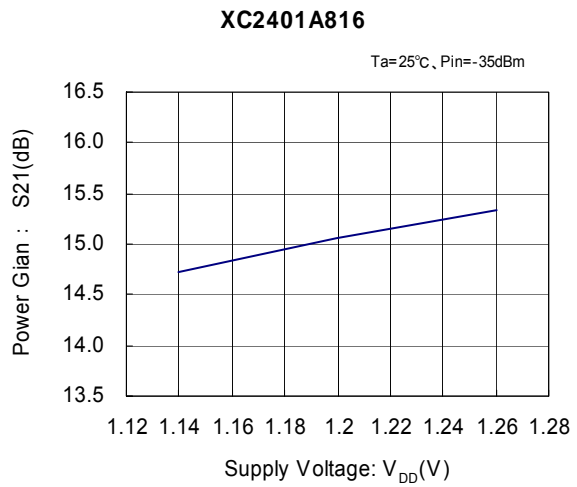

(3) Input Return Loss vs. Supply Voltage

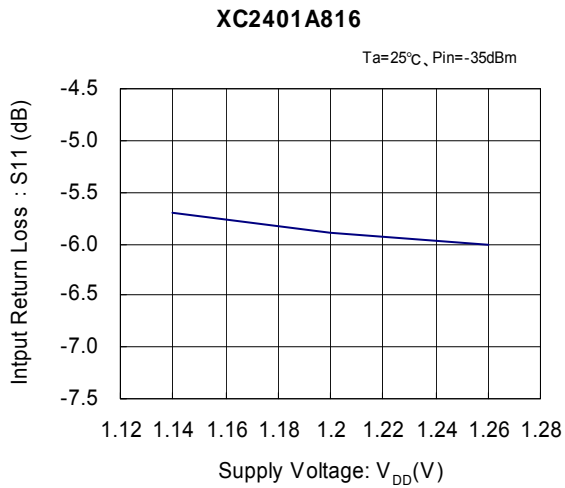

(4) Output Return Loss vs. Supply Voltage

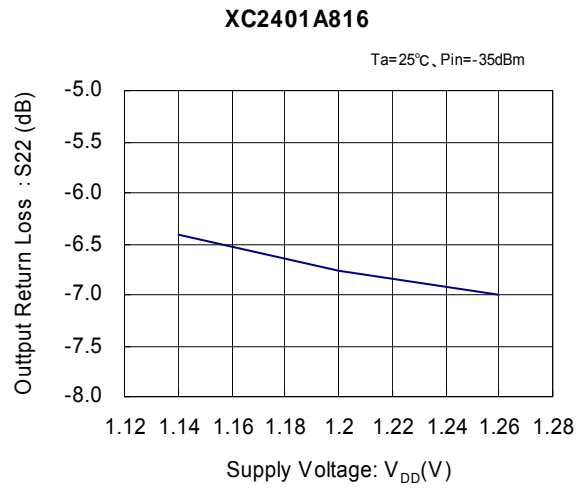

(5) Reverse Isolation vs. Supply Voltage

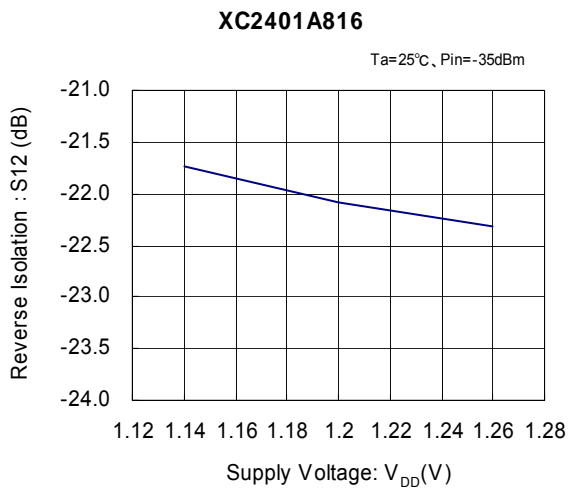

(6) Noise Figure vs. Supply Voltage

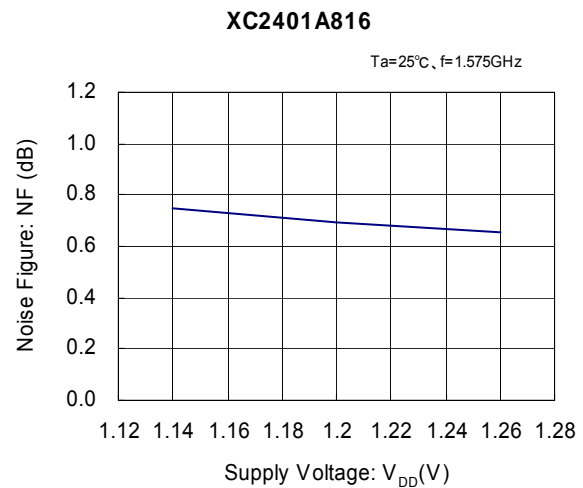

TYPICAL PERFORMANCE CHARACTERISTICS (Continued)

(7) Input 3 Order Intercept Point vs. Supply Voltage

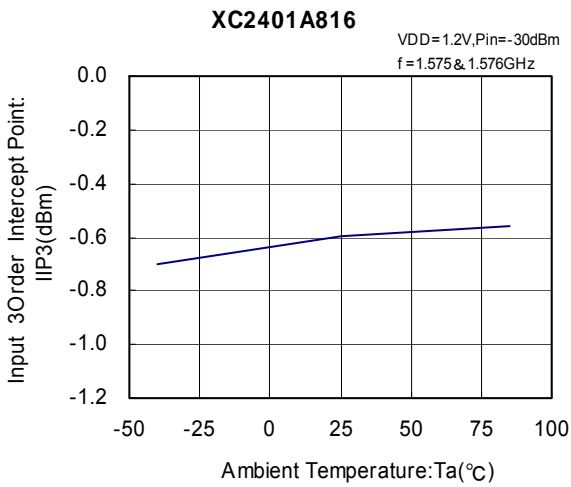

(8) Input Power @ 1dB Gain Compression vs. Power Supply Voltage

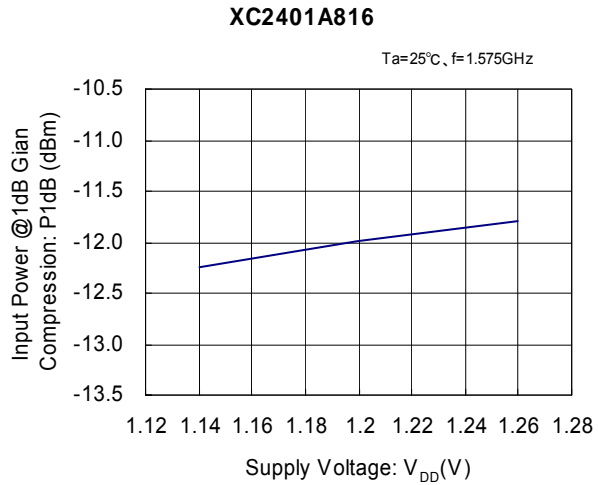

(9) Supply Current vs. Ambient Temperature

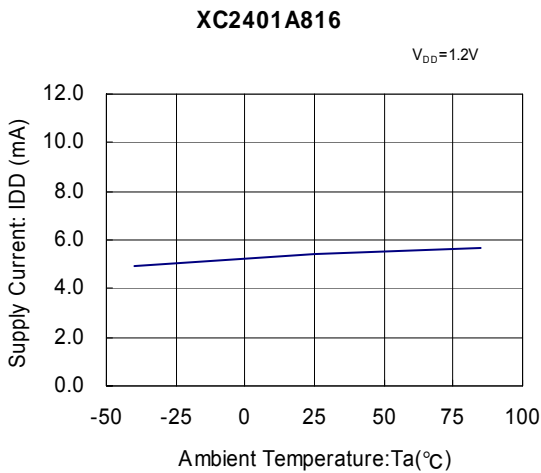

(10) Power Gain vs. Ambient Temperature

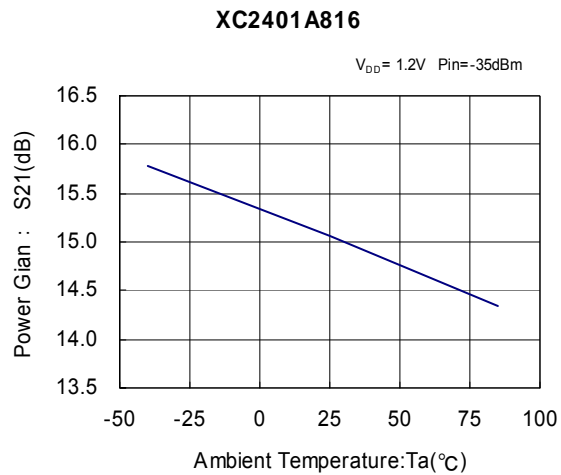

(11) Input Return Loss vs. Ambient Temperature

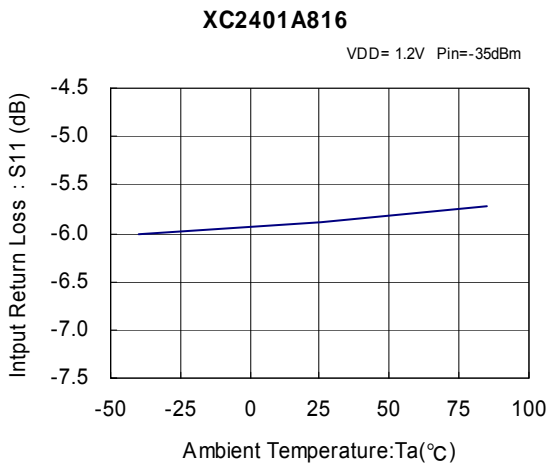

(12) Output Return Loss vs. Ambient Temperature

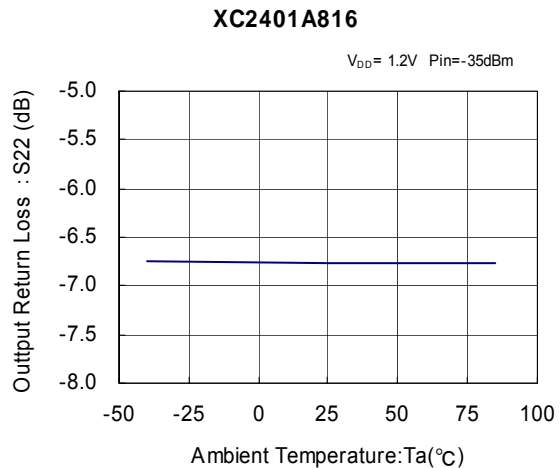

■ TYPICAL PERFORMANCE CHARACTERISTICS (Continued)

(13) Reverse Isolation vs. Ambient Temperature

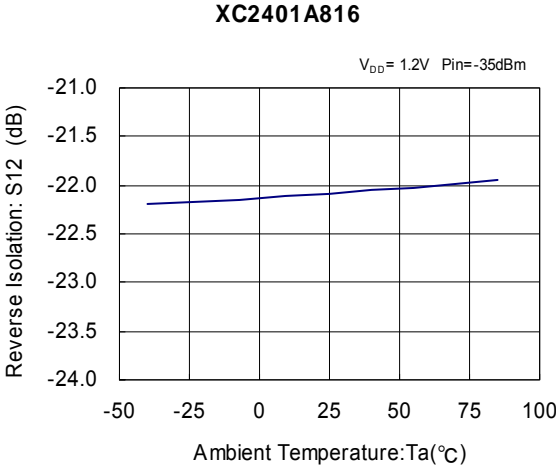

(14) Noise Figure vs. Ambient Temperature

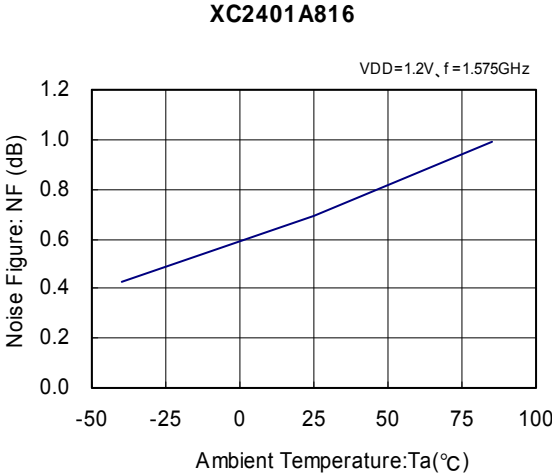

(15) Input 3 Order intercept point vs. Ambient Temperature

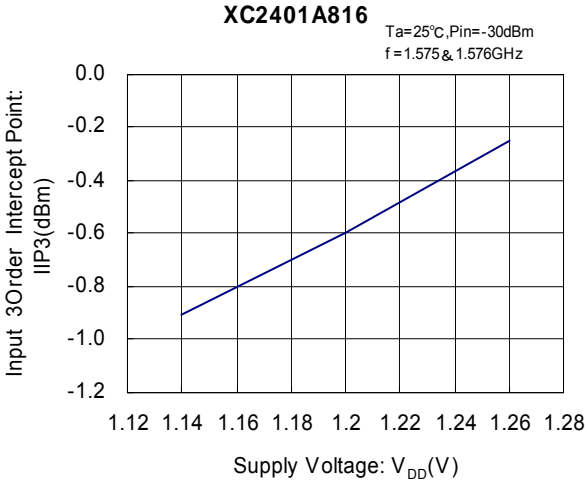

(16) Input Power @ 1dB Gain Compression vs. Ambient Temperature

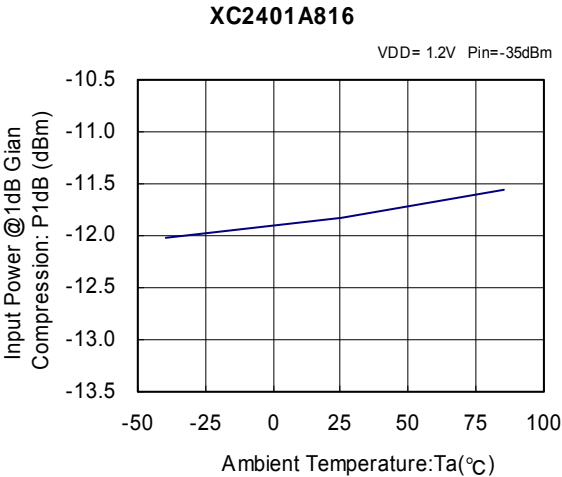

(17) Power Gain vs. Frequency

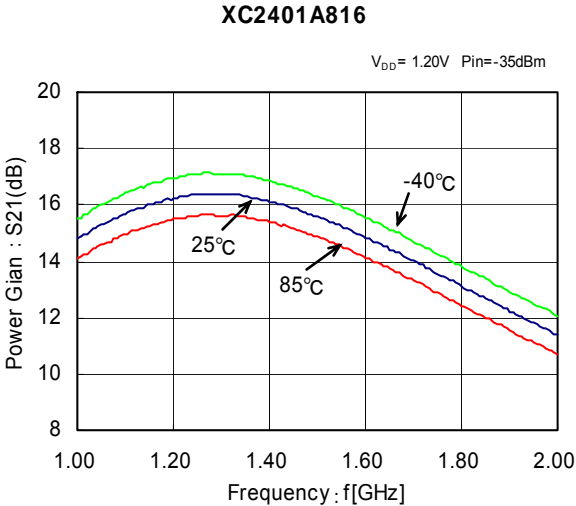

(18) Input Return Loss vs. Frequency

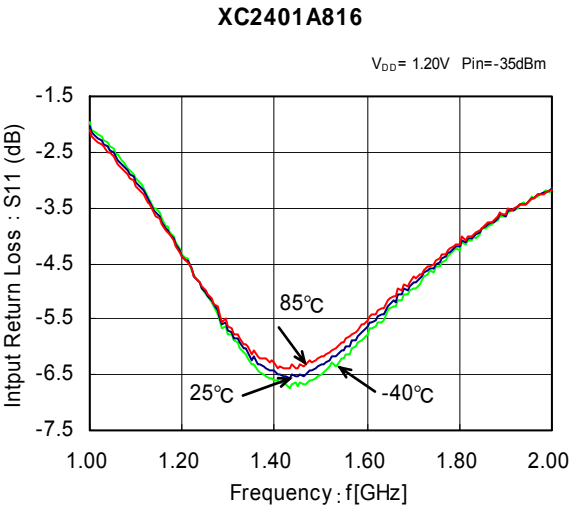

TYPICAL PERFORMANCE CHARACTERISTICS (Continued)

(19) Output Return Loss vs. Frequency

XC2401A816

$V_{DD} = 1.20V$ $P_{in} = -35dBm$

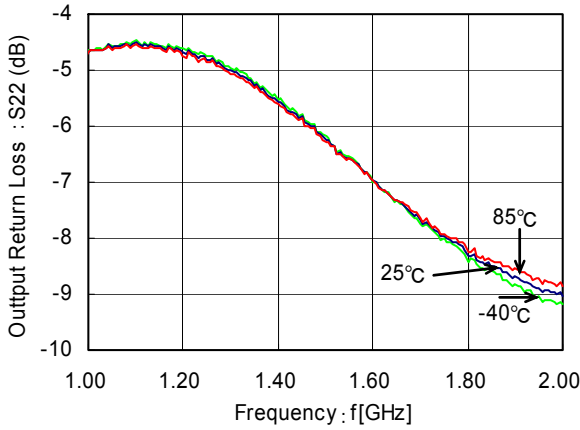

(20) Isolation vs. Frequency

XC2401A816

$V_{DD} = 1.20V$ $P_{in} = -35dBm$

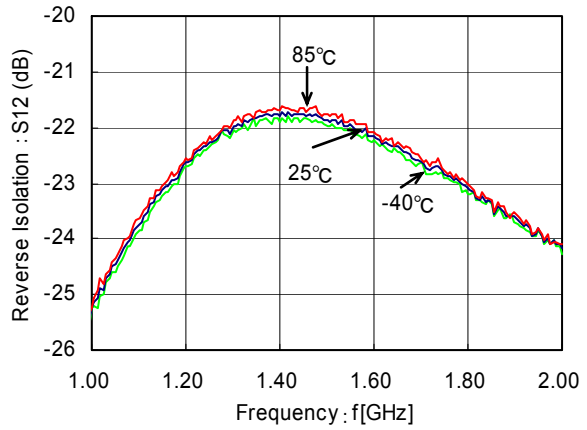

(21) Noise Figure vs. Frequency

XC2401A816

$V_{DD} = 1.20V$ $P_{in} = -35dBm$

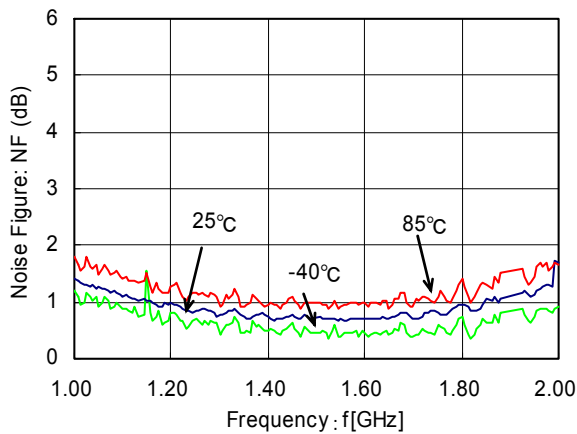

(22) Power Gain vs. Input Power

XC2401A816

$V_{DD} = 1.20V$, $f = 1.575GHz$

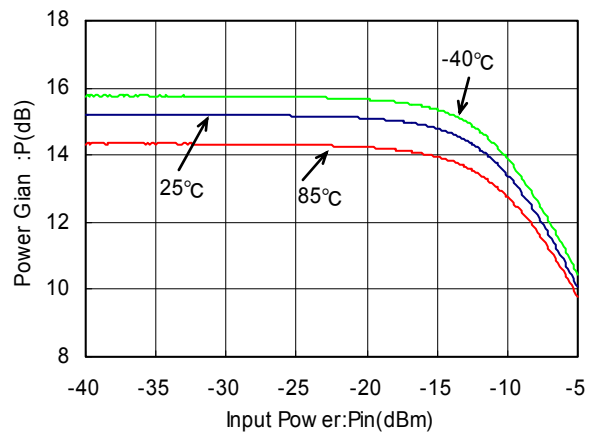

(23) Output Power / IM3 vs. Input Power

XC2401A816

$V_{DD} = 1.2V$, $T_a = 25^\circ C$

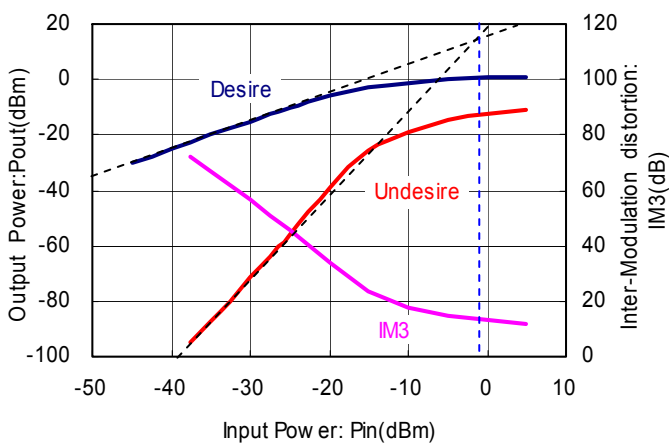

■ TYPICAL PERFORMANCE CHARACTERISTICS (Continued)

(24) Input Return Loss vs. Frequency (Smith Chart)

XC2401A816

V_{DD}=1.2V, P_{in}=-35dBm

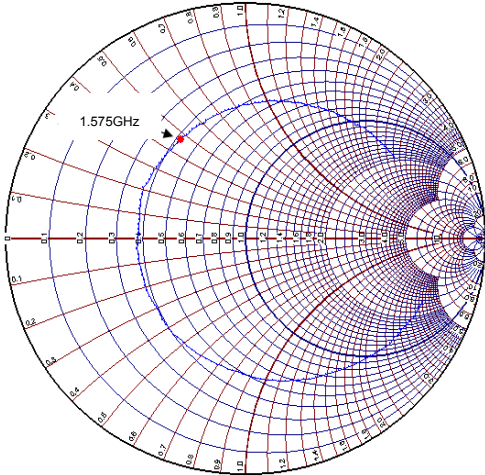

(25) Output Return Loss vs. Frequency (Smith Chart)

XC2401A816

V_{DD}=1.2V, P_{in}=-35dBm

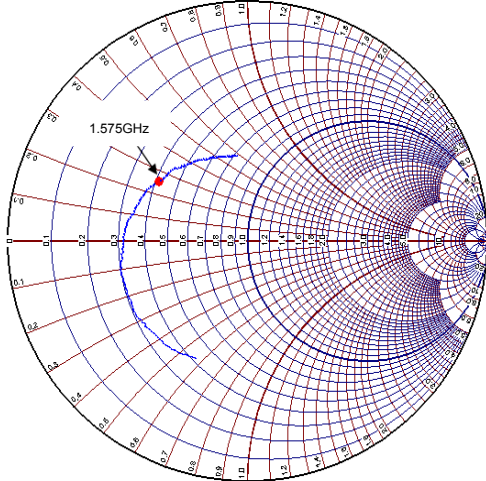

PACKAGING INFORMATION

●USPN-4B02

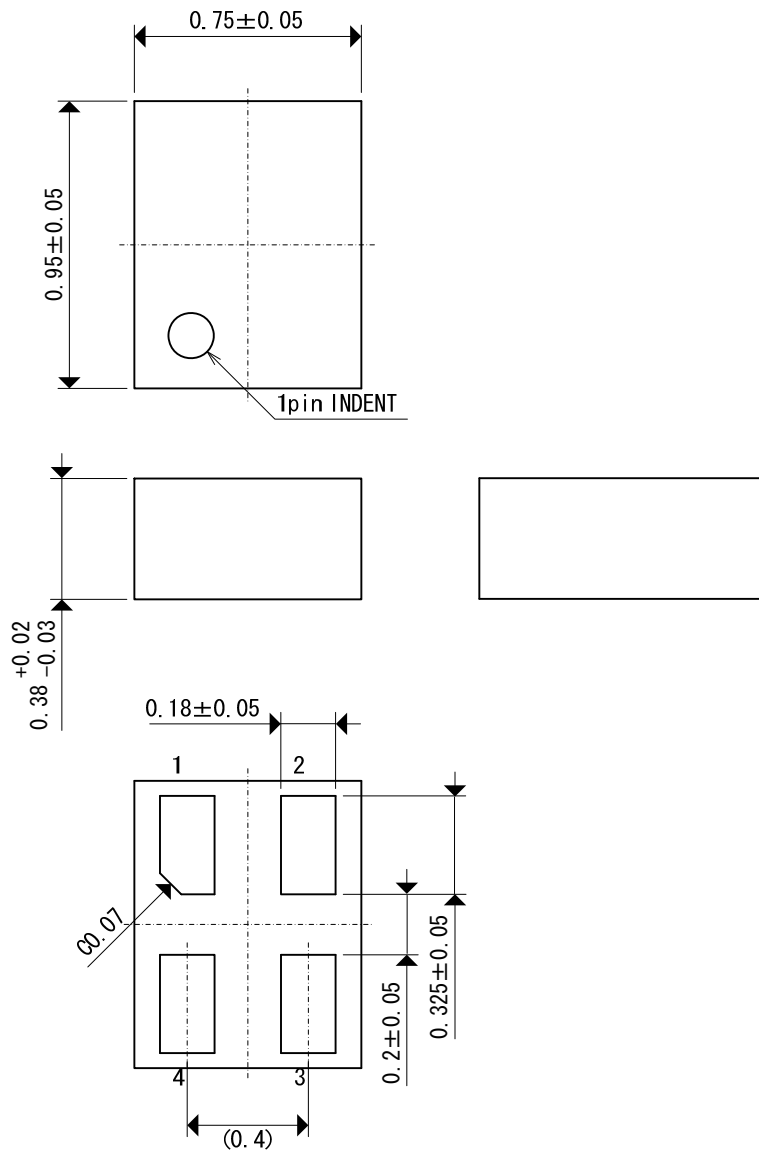

■ PACKAGING INFORMATION (Continued)

●USPN-4B02 Reference Pattern Layout

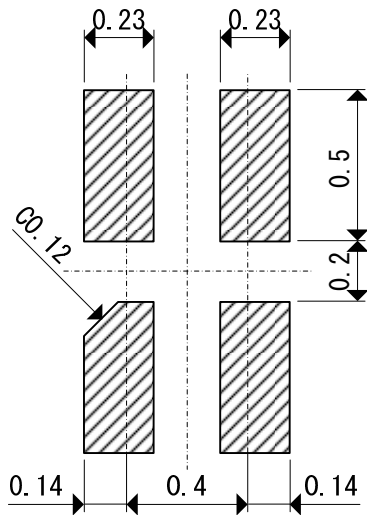

●USPN-4B02 Reference Metal Mask Design

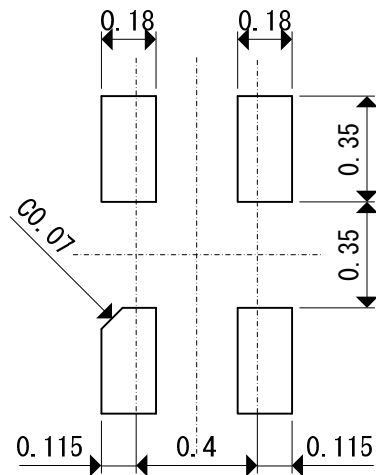

■ MARKING RULE

USPN-4B02

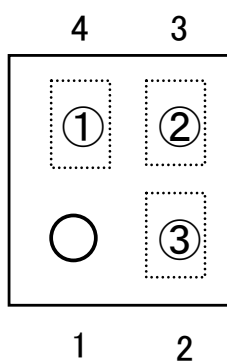

① represents product series.

MARK	PRODUCT SERIES
8	XC2401*****-G

② represents product.

MARK	PRODUCT SERIES
A	XC2401A816**-G

③ represents production lot number.

01 to 09, 0A to 0Z, 11 to 9Z, A1 to A9, AA to Z9, ZA to ZZ in order.

(G, I, J, O, Q, W excepted)

*No character inversion used.

1. The products and product specifications contained herein are subject to change without notice to improve performance characteristics. Consult us, or our representatives before use, to confirm that the information in this datasheet is up to date.
2. We assume no responsibility for any infringement of patents, patent rights, or other rights arising from the use of any information and circuitry in this datasheet.
3. Please ensure suitable shipping controls (including fail-safe designs and aging protection) are in force for equipment employing products listed in this datasheet.
4. The products in this datasheet are not developed, designed, or approved for use with such equipment whose failure or malfunction can be reasonably expected to directly endanger the life of, or cause significant injury to, the user.
(e.g. Atomic energy; aerospace; transport; combustion and associated safety equipment thereof.)
5. Please use the products listed in this datasheet within the specified ranges.
Should you wish to use the products under conditions exceeding the specifications, please consult us or our representatives.
6. We assume no responsibility for damage or loss due to abnormal use.
7. All rights reserved. No part of this datasheet may be copied or reproduced without the prior permission of TOREX SEMICONDUCTOR LTD.

TOREX SEMICONDUCTOR LTD.