

PS5R Standard Series — Switching Power Supplies



Key features of the PS5R standard series include:

- Wide Power Range: 7.5W-240W
- Universal Input:
7.5W-75W:85-264V AC/105-370V DC
100W:100-120V AC/200-240V AC
(Selectable) 240-370V DC
120W-240W:85-264V AC/105-370V AC
- Fused Input
- Overcurrent/Overvoltage Protection
- Power Factor Correction (75W, 120W, 240W models)
EN61000-3-3
EN61000-3-2
- Voltage adjustment + 10%
- Spring-up Screw Terminal, IP20 (finger-safe)
- DIN rail or Panel Surface Mount
- Approvals:
CE marked
UL 508 Listed
UL, c-UL
TUV approved
EMC Directives: EN50081-2
EN50082-2
EN61000-6-2
LVD EN60950:2000

L
Power Supplies



UL 508 Listed
File # E177168



Cert. No.
BL980213332392

Part Numbers

Part Number	Item	Watts	Rated Voltage	Rated Current
PS5R-A05		7.5	5V DC	1.5A
PS5R-A12			12V DC	0.6A
PS5R-A24			24V DC	0.3A
PS5R-B05		15	5V DC	2.5A
PS5R-B12			12V DC	1.2A
PS5R-B24			24V DC	0.6A
PS5R-C12		30	12V DC	2.5A
PS5R-C24			24V DC	1.3A
PS5R-D24		50	24V DC	2.1A
PS5R-Q24		75	24V DC	3.1A
PS5R-E24		100	24V DC	4.2A
PS5R-F24		120	24V DC	5A
PS5R-G24		240	24V DC	10A

Specifications

Part Numbers	5VDC output	PS5R-A05	PS5R-B05*	—	—	—	—	—	—	
	12VDC output	PS5R-A12	PS5R-B12	PS5R-C12	—	—	—	—	—	
	24VDC output	PS5R-A24	PS5R-B24	PS5R-C24	PS5R-D24	PS5R-Q24	PS5R-E24	PS5R-F24	PS5R-G24	
Output Capacity		7.5W	15W	30W	50W	75W	100W	120W	240W	
Input	Input Voltage (single-phase, 2-wire)	100 to 240VAC nominal (85 to 264V AC), 50/60Hz (47 to 63Hz) 110 to 340VDC nominal (105 to 370VDC)					100 to 120VAC, 50/60Hz 200 to 240VAC, 50/60Hz (jumper selectable) 240 to 370VDC		100 to 240VAC, 50/60Hz, 110 to 340VDC	
	Input Current (typical)	0.17A at 100VAC	0.3A at 100VAC	0.68A at 100VAC	1.15A at 100VAC	1.1A	2.5A at 100VAC 1.5A at 200VAC		1.8A	4A at 100VAC
	Internal Fuse Rating	2A	2A	3.15A	3.15A	3.15A	4A		4A	6.3A
	Inrush Current	50A maximum (at cold start at 200V AC)				70A maximum (at cold start at 230V AC)	50A maximum (at cold start at 200V AC)		70A maximum (at cold start at 230V AC)	
	Leakage Current (at no load)	0.75mA maximum (60Hz, measured in conformance with UL, CSA, VDE)								
	Typical Efficiency	69% at 5V 73% at 12V 75% at 24V	69% at 5V 75% at 12V 79% at 24V	75% at 12V 75% at 24V	79% at 24V	83% at 24V DC	85% at 24V		83% at 24V DC	83% at 24V
	Oversoltage Protection	Outputs turns off at 105% (typical)								
Output	Voltage and Current Ratings	5V, 1.5A 12V, 0.6A 24V, 0.3A	5V, 2.5A 12V, 1.2A 24V, 0.6A	12V, 2.5A 24V, 1.3A	24V, 2.1A	24V, 3.1A	24V, 4.2A		24V, 5A	24V, 10A
	Voltage Adjustments	±10% (V.ADJ screw on top)								
	Output Holding Time	20ms minimum (at full rated input and output)								
	Rise Time	200ms maximum (at full rated input and output)								150ms max.
	Line Regulation	0.4% maximum								
	Load Regulation	1.5% maximum								
	Fluctuation due to Ambient Temperature Change	0.05% maximum								
	Ripple Voltage	2% peak to peak maximum (including noise)								
	Overload Protection	120% typical (Zener-limiting)			120% typical, auto reset					
Operation Indicator	LED									
Parallel Operation	PS5R-A	PS5R-B	PS5R-C	PS5R-D	PS5R-Q	PS5R-E	PS5R-F	PS5R-G		
	No				Yes		No		Yes	
Dielectric Strength	Between input and output terminals: 3,000V AC, 1 minute Between input terminals and housing: 2,000V AC, 1 minute Between output terminal and housing: 500V AC, 1 minute									
Insulation Resistance	Between input and output terminals/input terminals and housing: 100MΩ minimum (500V DC megger)									
Operating Temperature	-10 to +60°C (14° to 140°F) (see derating curves)									
Storage Temperature	-30 to +85°C (-22° to 185°F)									
Operating Humidity	20 to 90% relative humidity (no condensation)									
Vibration Resistance	45m/s ² , 10 to 55Hz, 2 hours on each of 3 axes				10 to 50Hz, 0.75mm p-p, 2 hrs on each of 3 axes					
Shock Resistance	300m/s ² (30G), 3 shocks in each of 6 directions									
Approvals	Conforms to EMC Directives EN50081-2 & EN50082-2. LVD Directive EN60529 — Certified to EN60950. UL508 listed. UL, c-UL, TUV approved. CE marked. EN61000-3-2									
Weight	150g	170g	360g	390g	800g	600g	1200g	2000g		
Termination	Spring-up, fingersafe terminals with captive M3.5 screws									
IP protection	IP20 (finger safe)									
Dimensions H x W x D (mm)	75 x 45 x 70	75 x 45 x 95	75 x 90 x 95	75 x 90 x 95	120 x 85 x 140	75 x 145 x 95	120 x 115 x 140	120 x 200 x 140		
Dimensions H x W x D (inches)	2.95 x 1.77 x 2.76	2.95 x 1.77 x 3.74	2.95 x 3.54 x 3.74	2.95 x 3.54 x 3.74	4.72 x 3.35 x 5.52"	2.95 x 5.71 x 3.74"	4.72 x 4.53 x 5.52	4.72 x 7.87 x 5.51		



1. For dimensional drawings, see page L-12.
2. For usage instructions, see page L-11.
3. *12.5W for 5VDC model.

Temperature Derating Curves

PS5R-A/B

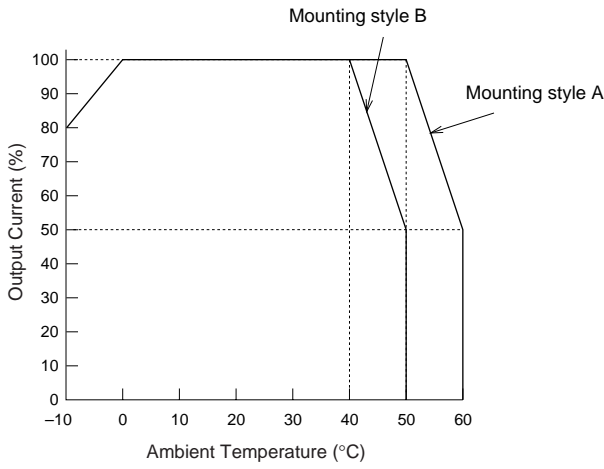

PS5R-C/D

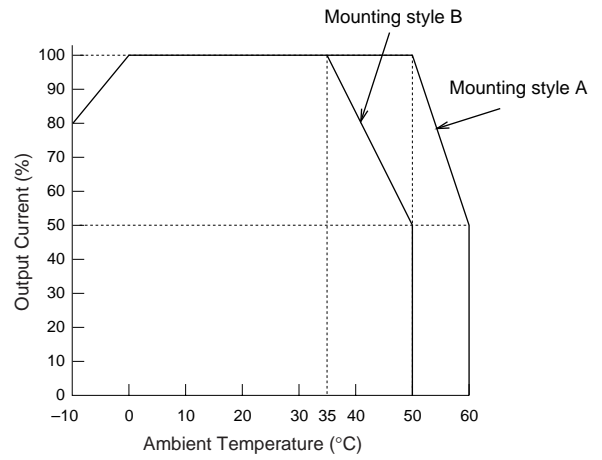

PS5R-E

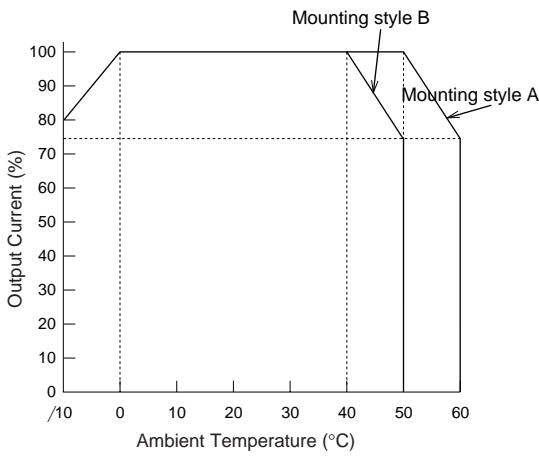

PS5R-Q

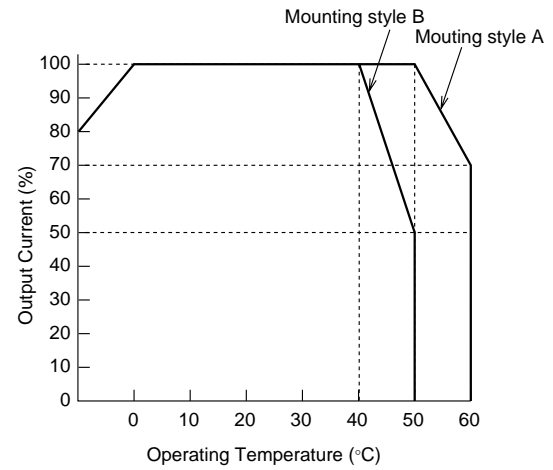

PS5R-F/G

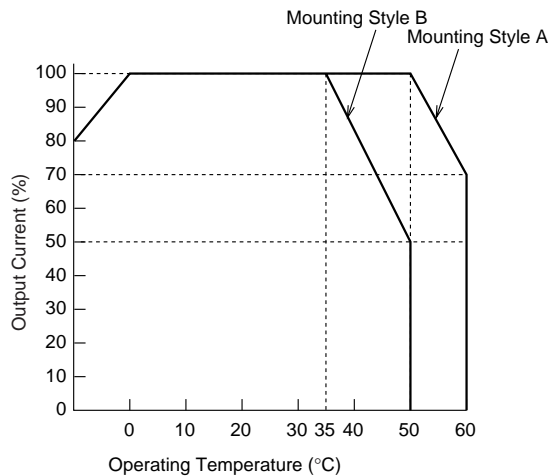

A Mounting

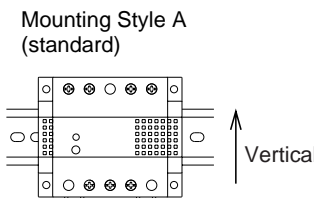

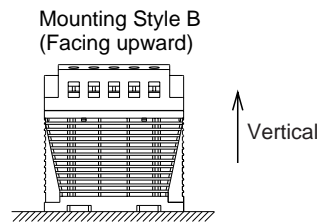

B Mounting



Accessories

Part Numbers: PS5R Accessories

Appearance	Description	Part Number
	DIN rail (1000mm)	BNDN1000
	DIN rail end clip	BNL5

Installation Instructions

Time-Saving Spring-up Terminals

The innovative terminals on the PS5R series use a special, spring-loaded screw. This makes installation as easy as pushing down and turning with a screwdriver. Installation time is cut in half since the screws do not need to be backed out to install wiring. The screws are held captive once installed and are 100% finger-safe. Screw terminals accept bare wire or ring or fork connectors.

1. Insert the wire connector into the slot on the side of the power supply.
2. Using a Phillips screwdriver, push down and turn the screw.

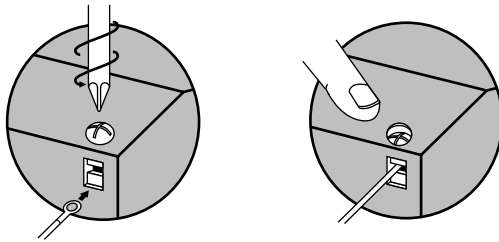

The wire is now connected, and the screw terminal is finger-safe!

Front Panel (terminals)

Terminal	Name	Description
V. ADJ	Voltage adjustment	Adjusts within $\pm 10\%$; turn clockwise to increase output voltage
DC ON	Operation indicator	Green LED is lit when output voltage is on
+V, -V	DC output terminals	+V: Positive output terminal -V: Negative output terminal
	Frame ground	Ground this terminal to reduce high-frequency currents caused by switching
L, N	Input terminals	Accept a wide range of voltages and frequencies (no polarity at DC input)
NC	No connection	Do <i>not</i> insert wires here, as this may damage the power supply

Overcurrent Protection Characteristics

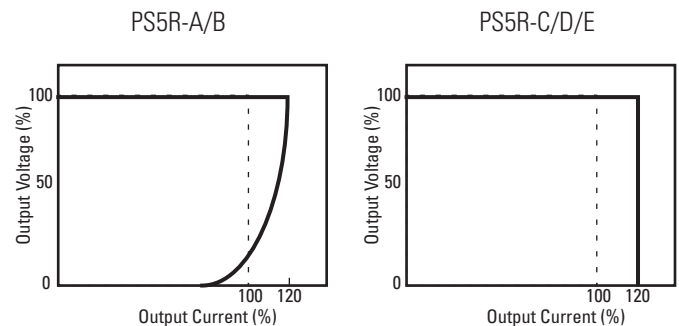

Parallel Operation

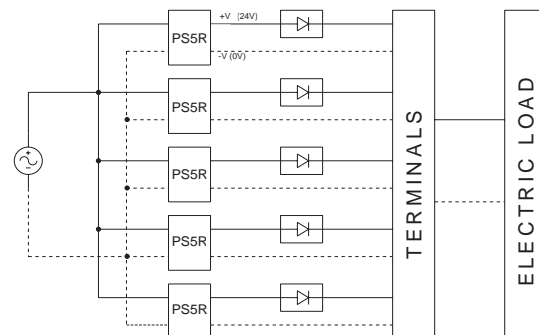

Parallel operation only recommended for PS5R-Q24, PS5R-F24 and PS5R-G24.

Dimensions

PS5R-A (7.5W)

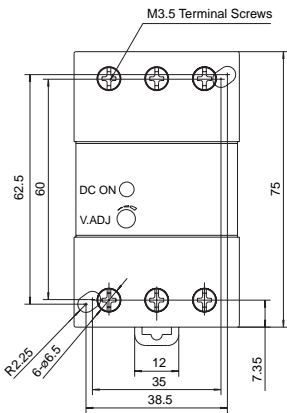

Height 75.0 mm
Width 45.0 mm
Depth 70.0 mm

PS5R-B (15W)

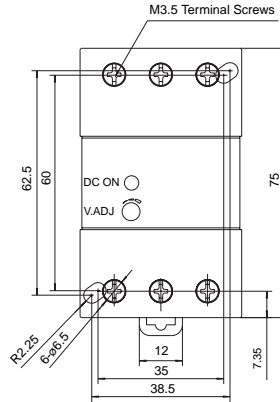

Height 75.0 mm
Width 45.0 mm
Depth 95.0 mm

PS5R-C (30W)

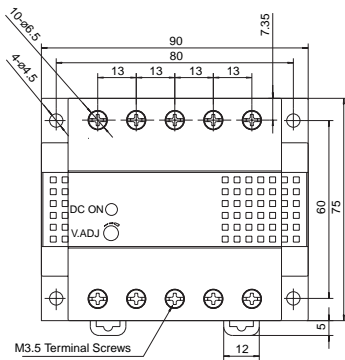

Height 75.0 mm
Width 90.0 mm
Depth 95.0 mm

PS5R-D (50W)

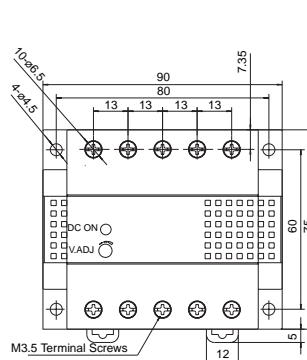

Height 75.0 mm
Width 90.0 mm
Depth 95.0 mm

PS5R-Q (75W)

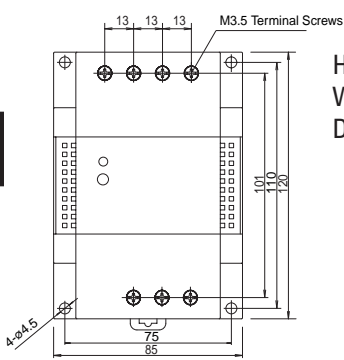

Height 120.0 mm
Width 85.0 mm
Depth 140.0 mm

PS5R-E (100W)

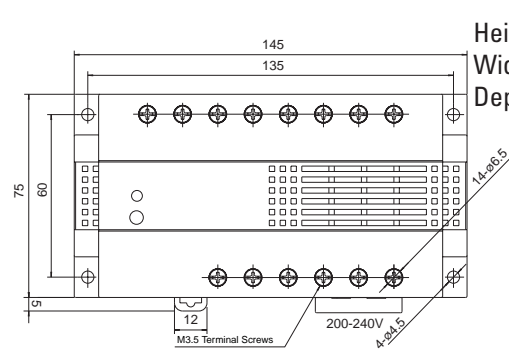

Height 75.0 mm
Width 145.0 mm
Depth 95.0 mm

PS5R-F (120W)

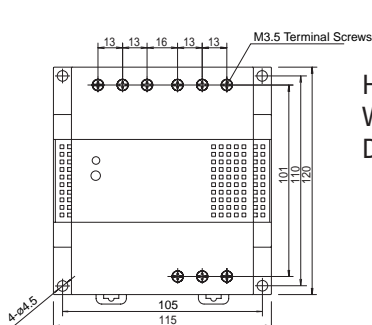

Height 120.0 mm
Width 115.0 mm
Depth 140.0 mm

PS5R-G (240W)

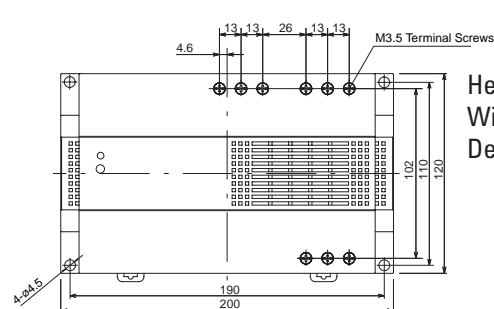

Height 120.0 mm
Width 200.0 mm
Depth 140.0 mm

Power Supplies **L**