

K-no.: 27094/02
K-Nr.:

Core design: Toroidal core
Ausführung: Ringbandkern

Application: Common Mode Choke
Anwendung: Stromkompensierte Drossel

Date: 26.08.2019
Datum:

Customer: Standard Type / Typenelement
Kunde:

Customer part no.:
Kd. Sach Nr.:

Page 1 **of** 6
Seite von

Drawing / Maßbild
Without scale / ohne Maßstab

Dimensions of the boxed core in mm /
Maße des getragten Kerns in mm

Marking:

Beschriftung:

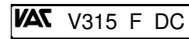

Prüfmaß (test dimension) DC = Date Code
F = Factory

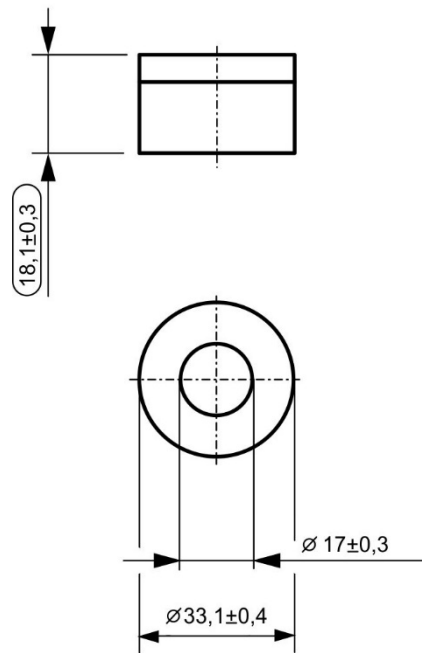

Date	Name	Issue	Amendment		
		01			

Hrsg.: R&D-PD NPI D editor	Bearb: NB designer	MC-PM: FTr. check	freig.: Pr. released
-------------------------------	-----------------------	----------------------	-------------------------

K-no.: 27094/02 K-Nr.:	Core design: Toroidal core Ausführung: Ringbandkern	Date: 26.08.2019 Datum:
	Application: Common Mode Choke Anwendung: Stromkompensierte Drossel	

Customer: Standard Type / Typenelement Kunde	Customer part no.: Kd. Sach Nr.:	Page 2 of 6 Seite von
---	-------------------------------------	--------------------------

Core material / Legierung: VITROPERM 500 F
Type of finish / Fixierung: Fix 022

Core fixing / Kernfixierung: silicone rubber / Silikonkautschuk
Material of casing / Trogmateriale: PA10T/X, GF30

SYMBOL	PARAMETER	VALUE / WERT	UNIT / EINHEIT
A _{Fe}	Effective area / Effektiver Eisen-Querschnitt	0,58	cm ²
l _{Fe}	Effective length / Effektive Länge	7,8	cm
m _{Fe}	Mass of bare core / blankes Kerngewicht	~ 33	g
m	Mass of fixing core / Gewicht des eingetrogten Kerns	~ 38	g
A _{L0} (10 kHz)	Nominal magnetic values / Magn. Nennwerte	30,7	μH
A _{L0} (100 kHz)	Nominal magnetic values / Magn. Nennwerte	16,3	μH
A _L (10 kHz, 100kHz)	Magnetic tolerance range / Magn. Toleranzbereich	-25 +45	%
T _{op}	Operating temperature / Betriebstemperatur	- 40 bis +150	°C
T _{st}	Storage temperature / Lagertemperatur	- 40 bis +85	°C

Inspection / Prüfung: (V: 100%-Test; AQL...: DIN ISO 2859-Part1, SC = significant characteristic)

Nr.	Parameter to test / Prüfparameter	Test method / Prüfmethode	Reference
Mechanical test			
1)	1.1) n = 5, c = 0 / lot / n = 5, C = 0 / Los All test dimensions according to drawing page 1 / alle Prüfmaße gemäß Maßbild Seite 1	Sample inspection	Test instrument: vernier calliper / Prüfmittel: Schieblehre
	1.2) Max. height acc to drawing page 1 / max Höhe gemäß Maßbild Seite 1	V	Test instrument: gauge / Prüfmittel: Lehre
3)	Magnetical test / magnetische Prüfung		Test of A _L -value in series mode according to A60092-Y3022- K009 / Prüfung des A _L -wertes im Reihenersatzschaltbild gemäß A60092-Y3022-K009
	3.1) Setting values / Einstellwerte I _{eff} x N = 16,7 mA**, f = 10 kHz 23,03μH < A _L (10 kHz) < 44,52μH SC **(corr. / entspr Hpeak=3mA/cm)	V	
	3.2) Setting values / Einstellwerte I _{eff} x N = 16,7 mA**, f = 100 kHz 12,23μH < A _L (100 kHz) < 23,64μH **(corr. / entspr Hpeak=3mA/cm)		

Measurements after temperature balance of the test samples at room temperature
Messungen nach Temperaturgleich der Prüflinge an Raumtemperatur

Hrsg.: R&D-PD NPI D editor	Bearb.: NB designer	MC-PM: FTr. check			freig.: Pr. released
-------------------------------	------------------------	----------------------	--	--	-------------------------

K-no.: 27094/02
 K-Nr.:

Core design: Toroidal core
 Ausführung: Ringbandkern
 Application: Common Mode Choke
 Anwendung: Stromkompensierte Drossel

Date: 26.08.2019
 Datum:

Customer: Standard Type / Typenelement
 Kunde

Customer part no.:
 Kd. Sach Nr.:

Page 3 of 6
 Seite von

Typical characteristics / Typische Kurven:

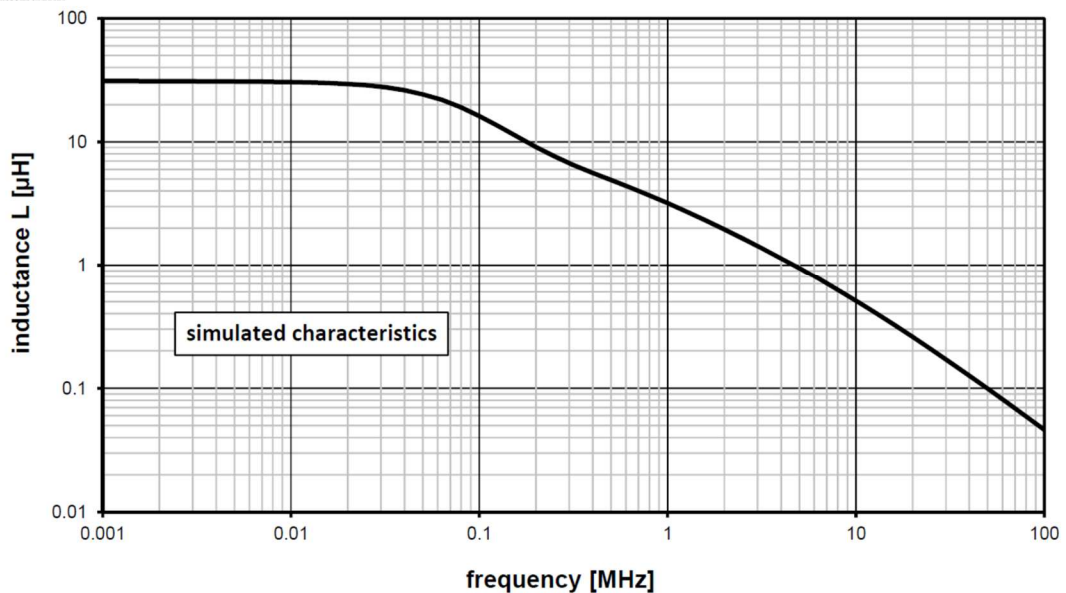
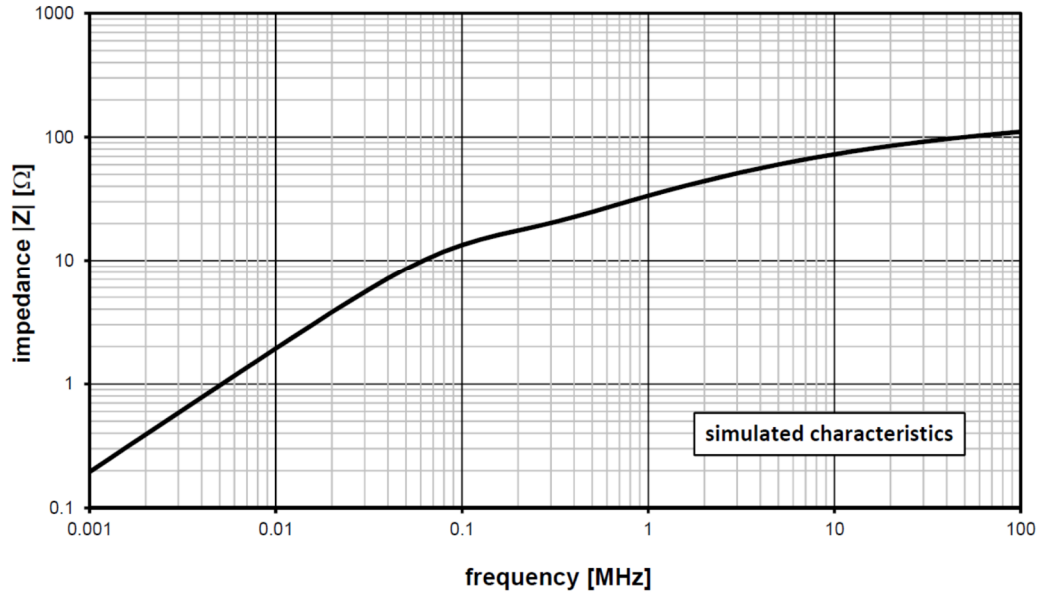

Hrsg.: R&D-PD NPI D
 editor

Bearb: NB
 designer

MC-PM: FTr.
 check

freig.: Pr.
 released

K-no.: 27094/02 K-Nr.:	Core design: Toroidal core Ausführung: Ringbandkern	Date: 26.08.2019 Datum:	
	Application: Common Mode Choke Anwendung: Stromkompensierte Drossel		
Customer: Standard Type / Typenelement Kunde	Customer part no.: Kd. Sach Nr.:	Page 4 of 6 Seite von	

Technical cleanliness / Technische Sauberkeit

VAC carries out regularly extraction analysis with similar cores. The similarity refers to the size and the manufacturing process of the component. The extraction analysis is based on the guideline on ZVEI and VDA-Band 19. On basis on this data material VAC can submit following proposal as preliminary. The final establishing will be done after minimum 5 analysis of serial product in serial production site / Die VAC führt regelmäßig Extraktionsanalysen an ähnlich Kernen durch. Die Ähnlichkeit bezieht sich auf die Größe und die Herstellverfahren. Diese Extraktionsanalysen werden auf Basis des ZVEI-Leitfadens und des VDA-Band 19 durchgeführt. Auf Basis dieses Datenmaterials kann die VAC folgenden Vorschlag als vorläufige Festlegung abgeben. Die finale Festlegung erfolgt nach mind. 5 Analysen von Produkten aus der Serienfertigung vom Serienstandort.

Current action control limits are shown in Table 1:

Aktuelle Eingriffsgrenzen in Tabellenform

Particle size x [µm]: Statistical maximum particle amount per 1000 cm² component surface area before shipment / Partikelgröße [µm]: Statistisch maximale Partikelmenge pro 1000 cm² Bauelementoberfläche vor Auslieferung

Particle size [µm]	Size class	Overall ¹	Metallic
x < 25	B-C	not evaluated	not evaluated
25 ≤ x < 50	D	19439	1860
50 ≤ x < 100	E	5130	720
100 ≤ x < 150	F	821	112
150 ≤ x < 200	G	202	29
200 ≤ x < 400	H	194	8
400 ≤ x < 600	I	21	1
600 ≤ x < 1000	J	8	1
>1000	K	3	0

Table 1: proposal of VAC towards technical cleanliness (reference surface : 1000 cm²)

Decay Curve	25.07.2019
Surface area per core	41,2 cm ²
Number of cores per analysis	15
Pre-spray quantity	500 ml
Waiting time between pre-spray a. cleaning	60 s
Spray quantity for cleaning	1,0 l
Rewash quantity for basin	500 ml

Table 1: Parameter cleanliness analysis

1: Overall: Metallic and non-metallic, non-fibrous particles.
Fibre definition: Compactness <30% or length/width > 10

Hrsg.: R&D-PD NPI D editor	Bearb: NB designer	MC-PM: FTr. check	freig.: Pr. released
-------------------------------	-----------------------	----------------------	-------------------------

K-no.: 27094/02
K-Nr.:

Core design: Toroidal core
Ausführung: Ringbandkern
Application: Common Mode Choke
Anwendung: Stromkompensierte Drossel

Date: 26.08.2019
Datum:

Customer: Standard Type / Typenelement
Kunde

Customer part no.:
Kd. Sach Nr.:

Page 5 **of** 6
Seite von

2. Packaging, drawings, quantities and weight / Skizzen, Mengen und Gewichte

A) Tray / Formling

Drawing / Skizze

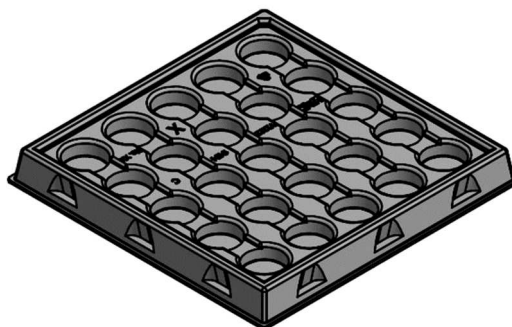
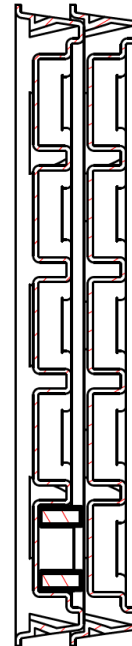
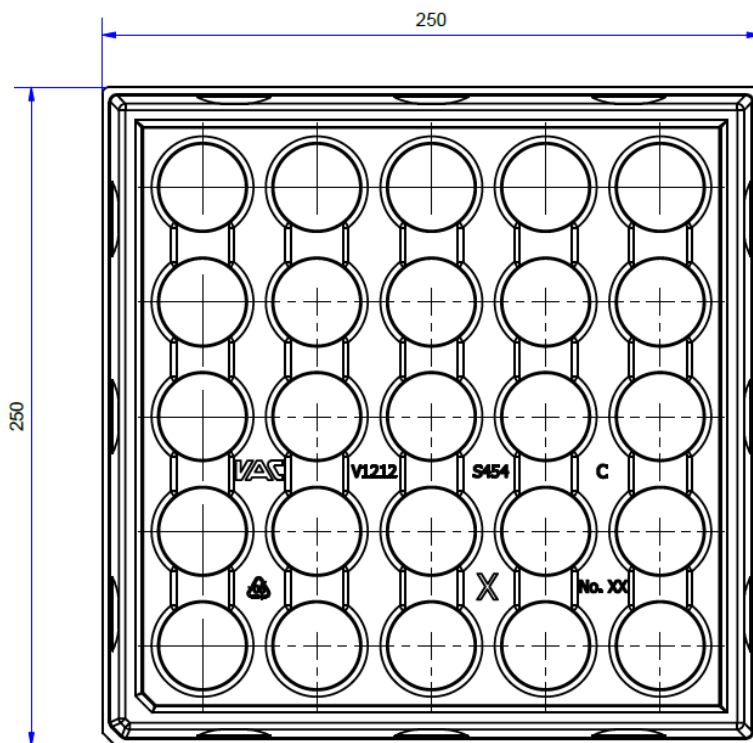
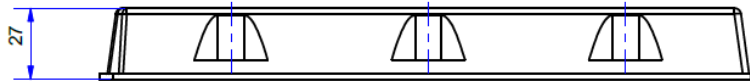

Hrsg.: R&D-PD NPI D
editor

Bearb.: NB
designer

MC-PM: FTr.
check

freig.: Pr.
released

K-no.: 27094/02 K-Nr.:	Core design: Toroidal core Ausführung: Ringbandkern	Date: 26.08.2019 Datum:
	Application: Common Mode Choke Anwendung: Stromkompensierte Drossel	

Customer: Standard Type / Typenelement Kunde	Customer part no.: Kd. Sach Nr.:	Page 6 of 6 Seite von
---	-------------------------------------	--------------------------

B) Outer packaging / Umverpackung

Drawing / Skizze

carton for type V315

Der verbleibende freie Raum oberhalb der Trays muss komplett mit Karton-Lagen aufgefüllt sein.
Die Trays müssen sicher fixiert sein und dürfen keine Möglichkeit zur Bewegung haben, wenn der Umkarton geschlossen ist.

The remaining free space on the top of the trays must be completely filled up with layers.
The trays must fit save without any possibility of movement when the outer carton box is closed.

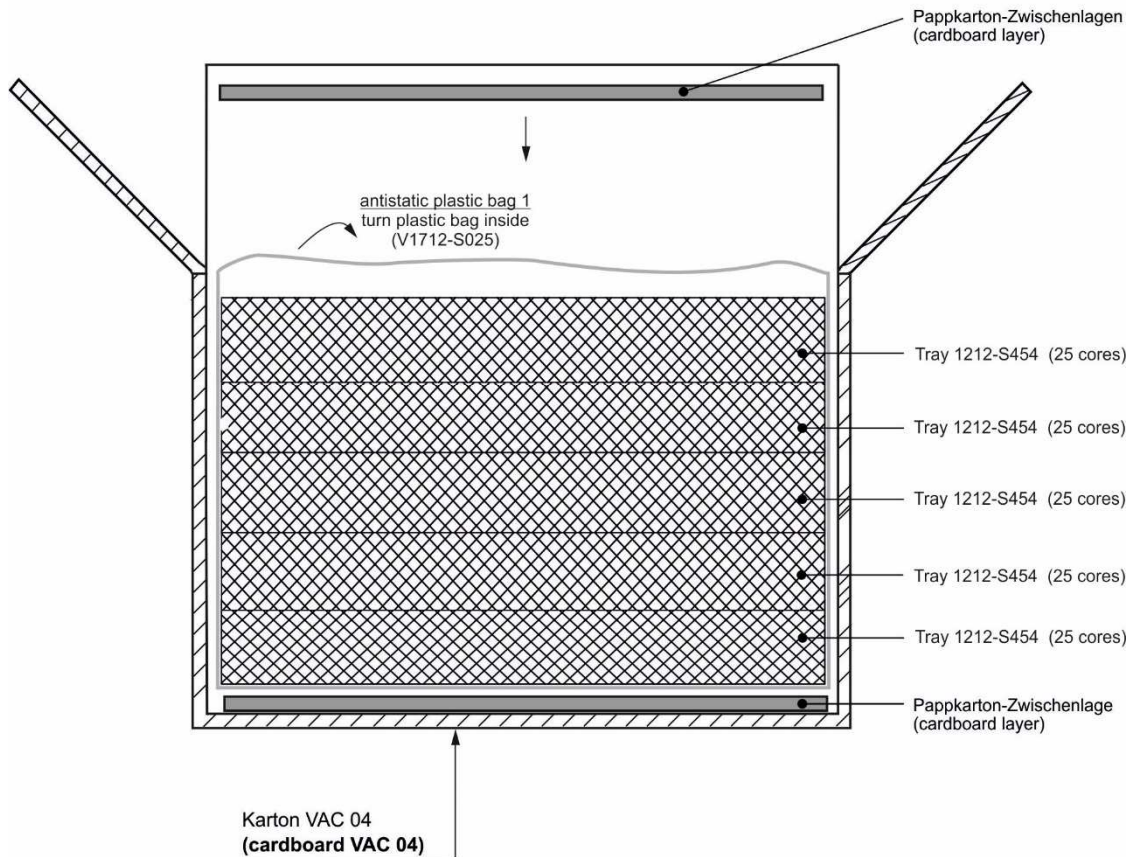

125 Stück Kerne in einem Karton
125 pcs cores in the cardboard

Weight carton loaded: 6,5 kg / Gesamtgewicht Karton befüllt

Outer dimensions carton: 257 x 257 x 132 mm / Außenmaße Karton

Hinweis, Materialnr.: / Remark, Part Nr.: 96881554

Hrsg.: R&D-PD NPI D editor	Bearb: NB designer	MC-PM: FTr. check	freig.: Pr. released
-------------------------------	-----------------------	----------------------	-------------------------