

## HIGH NOISE REDUCTION HIGH SPEED ANALOG OUTPUT 5 PIN SOP OPTOCOUPLER

### PS8701

#### FEATURES

- **HIGH COMMON MODE TRANSIENT IMMUNITY:**  
CMH, CML:  $\pm 10$  kV/ $\mu$ s MIN
- **HIGH ISOLATION VOLTAGE:**  
BV: 2500 V<sub>r.m.s.</sub>
- **HIGH SUPPLY VOLTAGE:**  
V<sub>CC</sub> = 35 V
- **HIGH SPEED RESPONSE:**  
t<sub>PHL</sub> = 0.8  $\mu$ s MAX, t<sub>PLH</sub> = 1.2  $\mu$ s MAX
- **AVAILABLE IN TAPE AND REEL:**  
PS8701-E3, E4, F3, F4



ESD SENSITIVE

#### DESCRIPTION

The PS8701 is an optically coupled isolator containing a GaAlAs LED on the light emitting diode (input) side and a PIN photodiode and a high speed amplifier transistor on the output side on one chip. Its small package makes it ideal for high density circuits and applications.

#### APPLICATIONS

- COMPUTERS AND PERIPHERALS
- GENERAL PURPOSE INVERTER
- POWER SUPPLIES
- RELAY AND PULSE TRANSFORMER REPLACEMENTS

#### ELECTRICAL CHARACTERISTICS (T<sub>A</sub> = 25°C)

PART NUMBER			PS8701			
SYMBOLS	PARAMETERS	UNITS	MIN	TYP	MAX	
Diode	V <sub>F</sub>	Forward Voltage, I <sub>F</sub> = 16 mA	V	1.7	2.2	
	I <sub>R</sub>	Reverse Current, V <sub>R</sub> = 3 V	$\mu$ A		10	
	$\Delta V_F / \Delta T$	Forward Voltage Temp. Coefficient, I <sub>F</sub> = 16 mA	mV/°C	-1.6		
	C <sub>t</sub>	Terminal Capacitance, V = 0 V, f = 1.0 MHz	pF	60		
Detector	I <sub>OH(1)</sub>	High Level Output Current I <sub>F</sub> = 0 mA, V <sub>CC</sub> = V <sub>O</sub> = 5.5 V	nA	3	500	
	I <sub>OH(2)</sub>	High Level Output Current I <sub>F</sub> = 0 mA, V <sub>CC</sub> = V <sub>O</sub> = 30 V	$\mu$ A		100	
	V <sub>OL</sub>	Low Level Output Voltage I <sub>F</sub> = 16 mA, V <sub>CC</sub> = 4.5 V, I <sub>O</sub> = 1.2 mA	V	0.1	0.4	
	I <sub>CCL</sub>	Low Level Supply Current I <sub>F</sub> = 16 mA, V <sub>O</sub> = Open, V <sub>CC</sub> = 30 V	$\mu$ A	50		
	I <sub>CCH</sub>	High Level Supply Current I <sub>F</sub> = 0 mA, V <sub>O</sub> = Open, V <sub>CC</sub> = 30 V	$\mu$ A	0.01	2	
Coupled	CTR	Current Transfer Ratio, I <sub>F</sub> = 16 mA, V <sub>CC</sub> = 4.5 V, V <sub>O</sub> = 0.4 V	%	15	20	35
	R <sub>I-O</sub>	Isolation Resistance, V <sub>IN-OUT</sub> = 1k V <sub>DC</sub> , R <sub>H</sub> = 40 to 60 %	$\Omega$	10 <sup>11</sup>		
	C <sub>I-O</sub>	Isolation Capacitance, V = 0, f = 1.0 MHz	pF	0.4		
	t <sub>PHL</sub>	Propagation Delay Time, (High $\rightarrow$ Low) <sup>1</sup> I <sub>F</sub> = 16 mA, V <sub>CC</sub> = 5 V, R <sub>L</sub> = 2.2 k $\Omega$ , C <sub>L</sub> = 15 pF	$\mu$ s		0.5	0.8
	t <sub>PLH</sub>	Propagation Delay Time, (Low $\rightarrow$ High) <sup>1</sup> I <sub>F</sub> = 16 mA, V <sub>CC</sub> = 5 V, R <sub>L</sub> = 2.2 k $\Omega$ , C <sub>L</sub> = 15 pF	$\mu$ s		0.6	1.2
	CMH	Common Mode Transient Immunity at High Level Output <sup>2</sup> I <sub>F</sub> = 0 mA, V <sub>CC</sub> = 5 V, R <sub>L</sub> = 4.1 k $\Omega$ , V <sub>CM</sub> = 1.5 kV	kV/ $\mu$ s	10		
	CML	Common Mode Transient Immunity at Low Level Output <sup>2</sup> I <sub>F</sub> = 16 mA, V <sub>CC</sub> = 5 V, R <sub>L</sub> = 4.1 k $\Omega$ , V <sub>CM</sub> = 1.5 kV	kV/ $\mu$ s	-10		

PLEASE SEE NOTES ON NEXT PAGE.

Pin Connection (Top View)

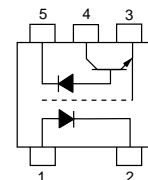

**ABSOLUTE MAXIMUM RATINGS<sup>1</sup>** (T<sub>A</sub> = 25°C)

SYMBOLS	PARAMETERS	UNITS	RATING
<b>Diode</b>			
I <sub>F</sub>	Forward Current	mA	25
V <sub>R</sub>	Reverse Voltage	V	3.0
P <sub>D</sub>	Power Dissipation	mW	45
<b>Detector</b>			
V <sub>CC</sub>	Supply Voltage	V	35
V <sub>O</sub>	Output Voltage	V	35
I <sub>O</sub>	Output Current	mA	8.0
P <sub>C</sub>	Power Dissipation	mW	100
<b>Coupled</b>			
BV	Isolation Voltage <sup>2</sup>	V <sub>r.m.s.</sub>	2500
T <sub>A</sub>	Operating Ambient Temp.	°C	-55 to +100
T <sub>STG</sub>	Storage Temperature	°C	-55 to +125

Notes:

1. Operation in excess of any one of these parameters may result in permanent damage.
2. AC voltage for one minute at T<sub>A</sub> = 25°C, RH = 60% between input and output.

**OUTLINE DIMENSIONS** (Units in mm)

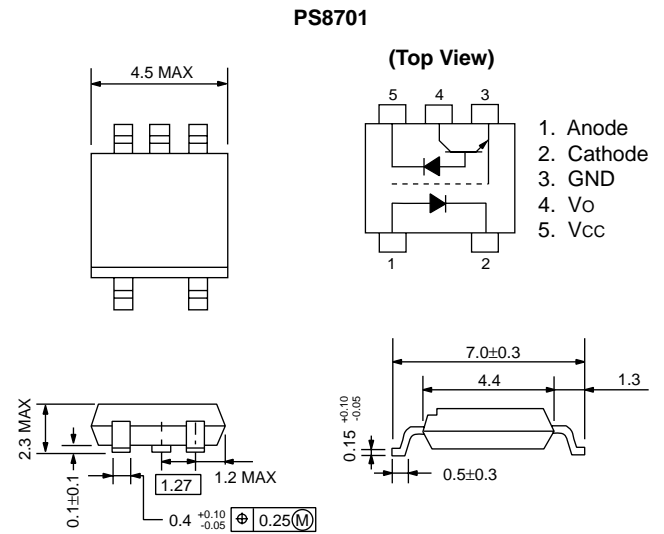

(Continued from previous pages)

NOTES:

1. Test Circuit for Propagation Delay Time:

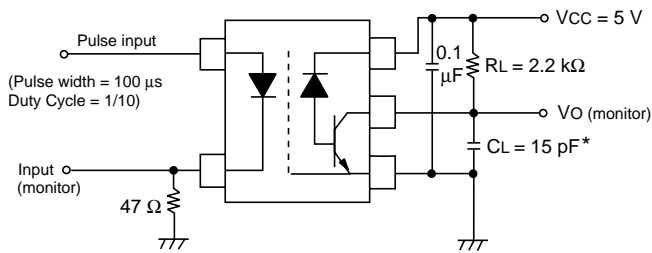

\*C<sub>L</sub> is approximately 15 pF which includes probe and stray wiring capacitance.

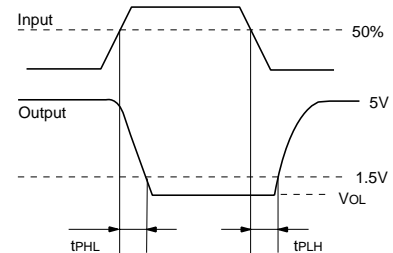

2. Test Circuit for Common Mode Transient Immunity:

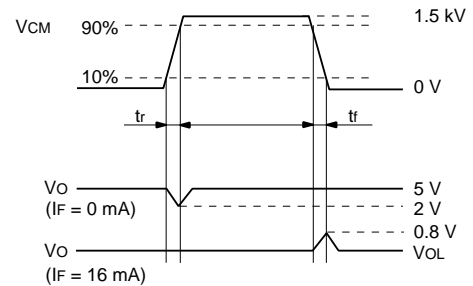
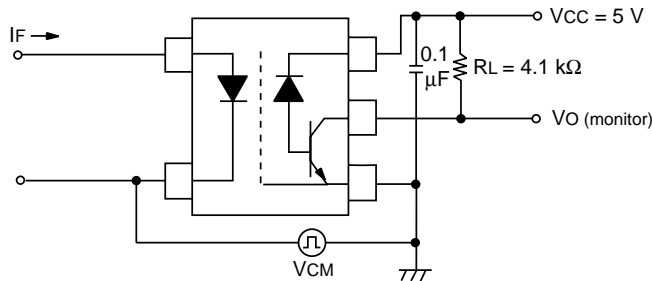

Usage Cautions:

1. When handling this product, precautions should be taken against static electricity.
2. A by-pass capacitor of ≥ 0.1 μF is used between V<sub>CC</sub> and GND.

**TYPICAL PERFORMANCE CURVES** ( $T_A = 25\text{ }^\circ\text{C}$ )

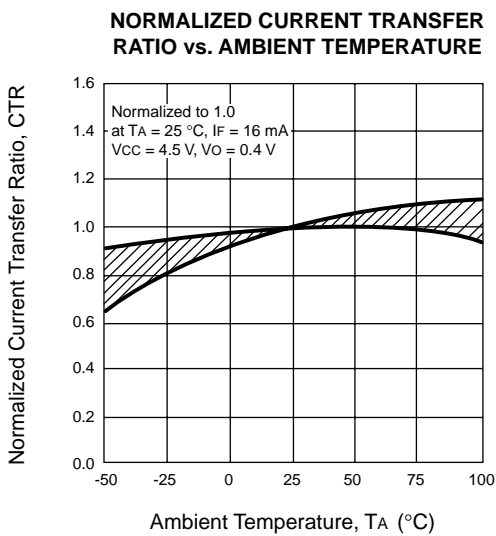
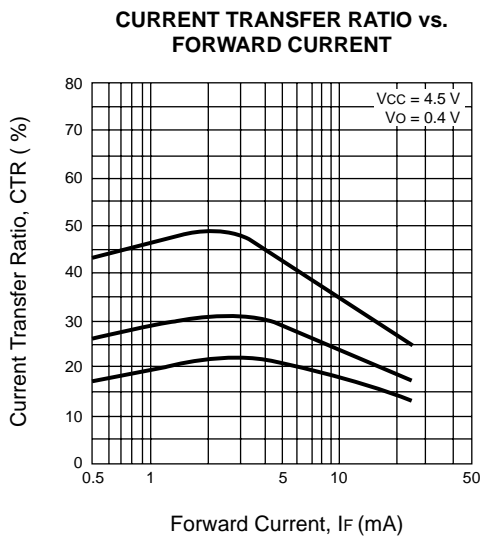
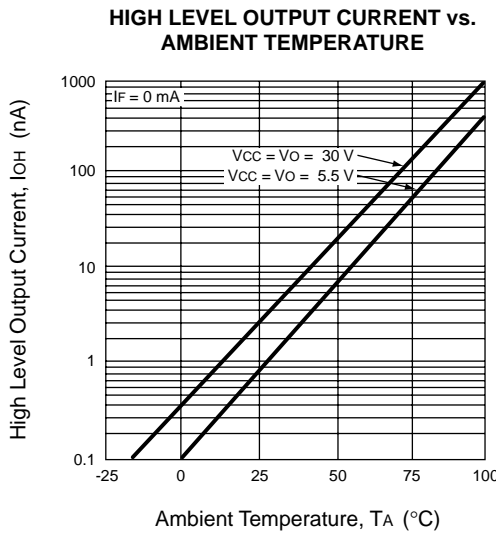
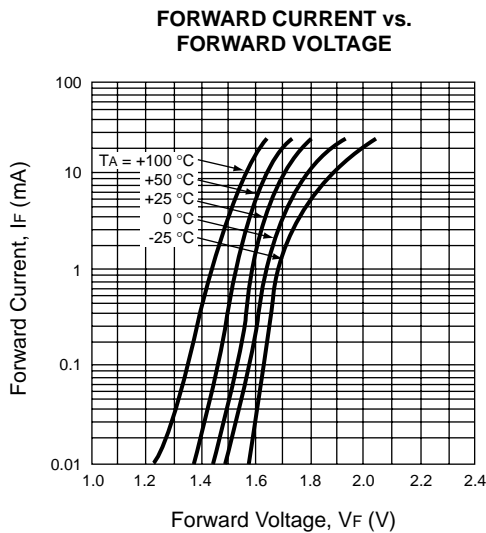
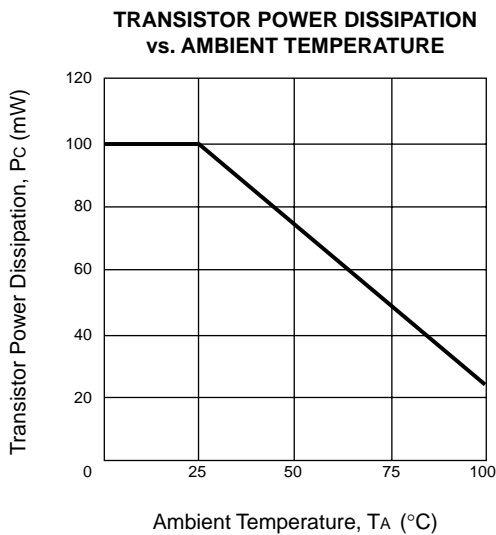
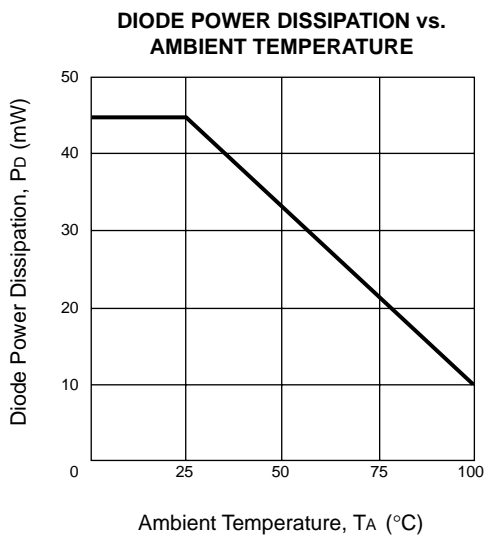

TYPICAL PERFORMANCE CURVES (TA = 25 °C)

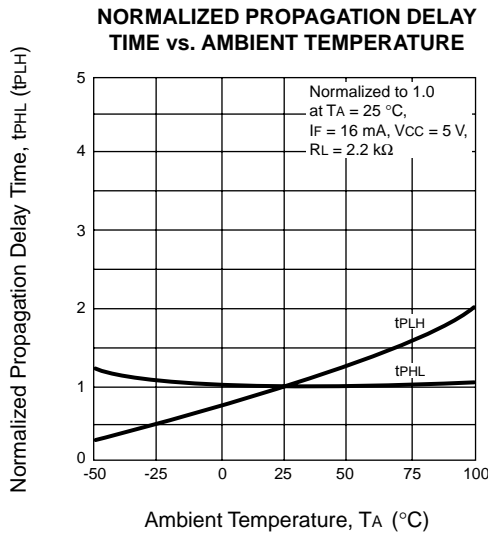
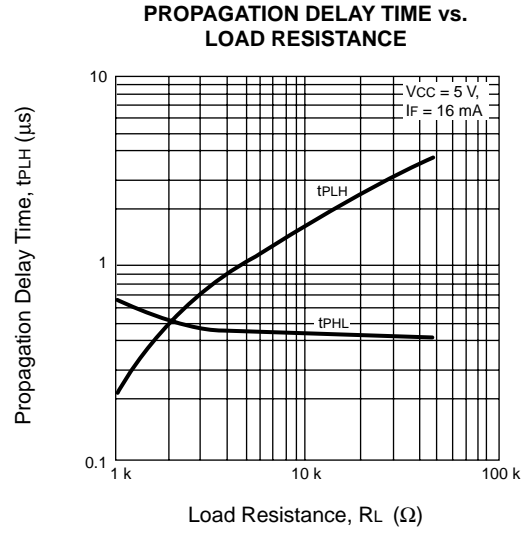
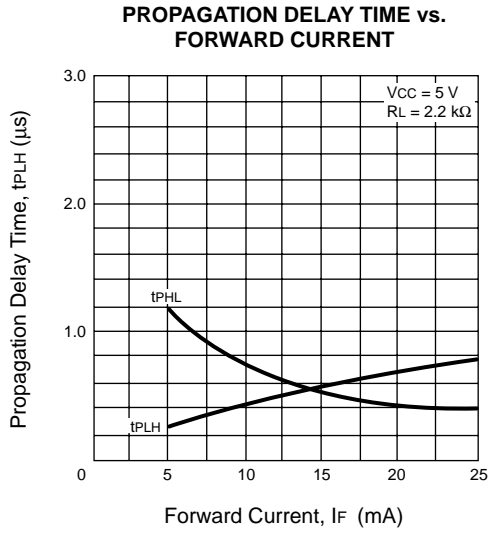
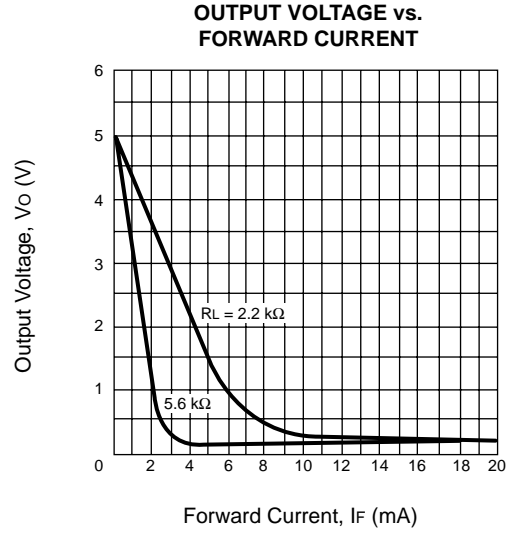
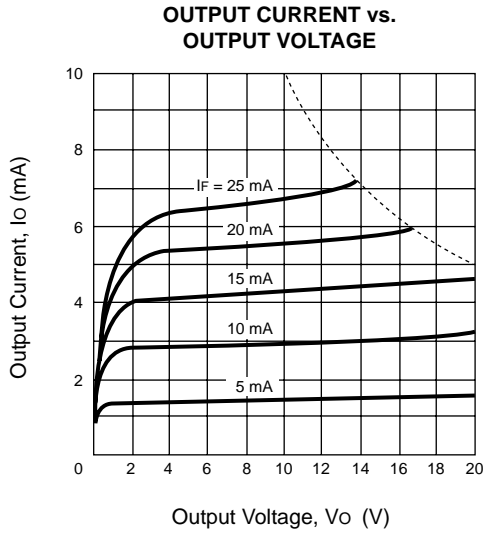

**TAPING SPECIFICATIONS** (Units in mm)

**OUTLINE AND DIMENSIONS (TAPE)**

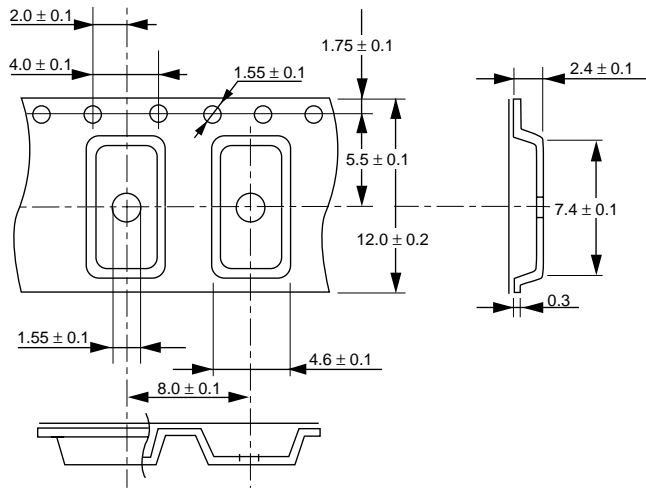

**OUTLINE AND DIMENSIONS (REEL)**

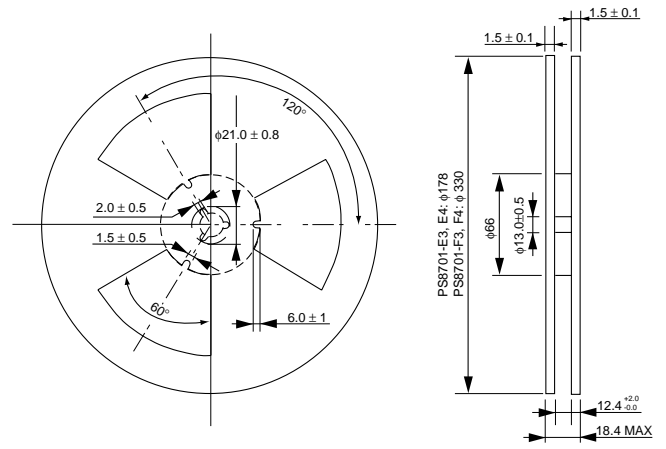

Notes:

1. Packing : PS8701-E3, E4 900 pcs/reel  
PS8701-F3, F4 3500 pcs/reel

**TAPE DIRECTION**

**PS8701-E3  
PS8701-F3**

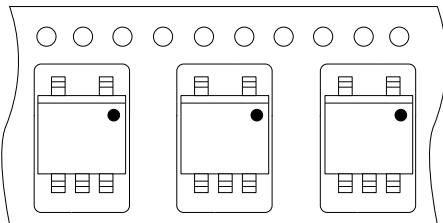

**PS8701-E4  
PS8701-F4**

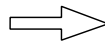
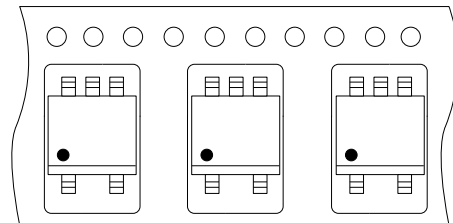

**RECOMMENDED SOLDERING CONDITIONS**

**(1) Infrared reflow soldering**

- **Peak reflow temperature** 235 °C (package surface temperature)
- **Time of temperature higher than 210 °C** 30 seconds or less
- **Number of reflows** Three
- **Flux** Rosin flux containing small amount of chlorine (The flux with a max. chlorine content of 0.2 Wt % is recommended)

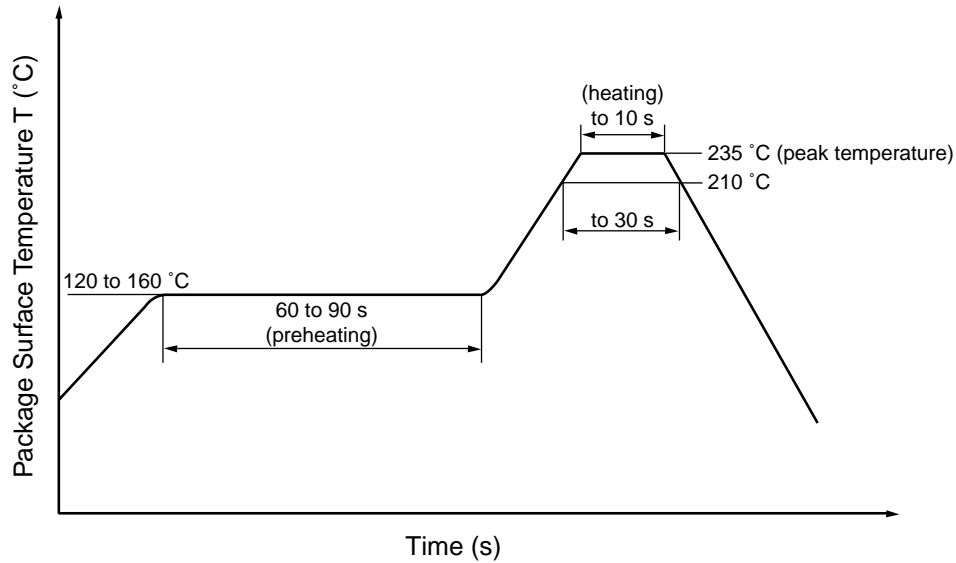

**Caution: Please avoid removing the residual flux by water after the first reflow process.**

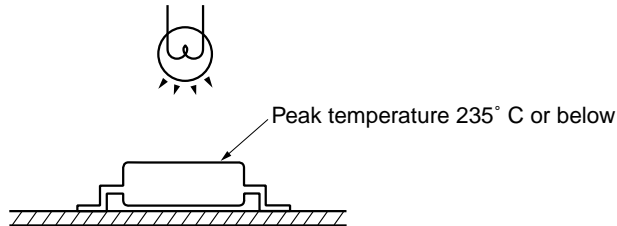

**(2) Dip soldering**

- **Temperature** 260 °C or below (molten solder temperature)
- **Time** 10 seconds or less
- **Number of times** One
- **Flux** Rosin flux containing small amount of chlorine (The flux with a max. chlorine content of 0.2 Wt % is recommended.)

**Life Support Applications**

These NEC products are not intended for use in life support devices, appliances, or systems where the malfunction of these products can reasonably be expected to result in personal injury. The customers of CEL using or selling these products for use in such applications do so at their own risk and agree to fully indemnify CEL for all damages resulting from such improper use or sale.

EXCLUSIVE NORTH AMERICAN AGENT FOR **NEC** RF, MICROWAVE & OPTOELECTRONIC SEMICONDUCTORS