

Surface Mount 2436.00MHz SAW Filter

AFS14A72-2436.00-T2

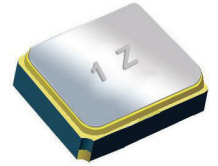

RoHS
Compliant



1.4 x 1.1 x 0.7 mm

FEATURES:

- 1.4 x 1.1 x 0.7 mm low profile SMT package
- Low Insertion loss
- Excellent selectivity with high out-of-band rejection

APPLICATIONS:

- Wireless Communication
- Remote Control
- Cellular Phones

ELECTRICAL SPECIFICATIONS:

Maximum Ratings

Item	Value
Input Power Level	+10 dBm max.
DC Permissive Voltage	3.0V DC max.
Operating Temperature Range	-30°C to + 85°C
Storage Temperature Range	-40°C to + 85°C

Parameters	Minimum	Typical	Maximum	Units	Notes
Center Frequency (f_c)		2436.00		MHz	
Insertion Loss (IL)		3.5	4.4	dB	(2400.00~2472.00MHz)
3-dB Bandwidth		72		MHz	
Amplitude Ripple		2.0	3.3	dB	(2400.00~2472.00MHz)
Worst-Case Input / Output Return Loss		9.54	7.35	dB	
Stop-band Attenuation (Referenced to 0.0 dB)	25	35		dB	DC~960 MHz
	25	33			960~1580 MHz
	25	34			1710~1990 MHz
	28	37			2110~2170 MHz
	30	40			2496~2690MHz @ 25°C
	10	20			2496~2690MHz over the operating temperature
	25	44			2690~4800MHz
	20	36			4800~5000MHz
	15	31			5000~6000MHz
Terminating Source Impedance (Z_s)		50		Ω	
Temperature Coefficient of Frequency		-36		ppm/°C	

TEST CIRCUIT:

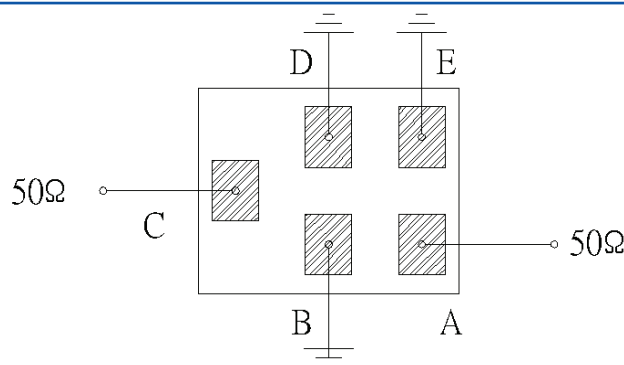

Surface Mount 2436.00MHz SAW Filter

AFS14A72-2436.00-T2

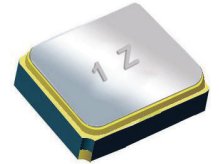

1.4 x 1.1 x 0.7 mm

OUTLINE DIMENSIONS:

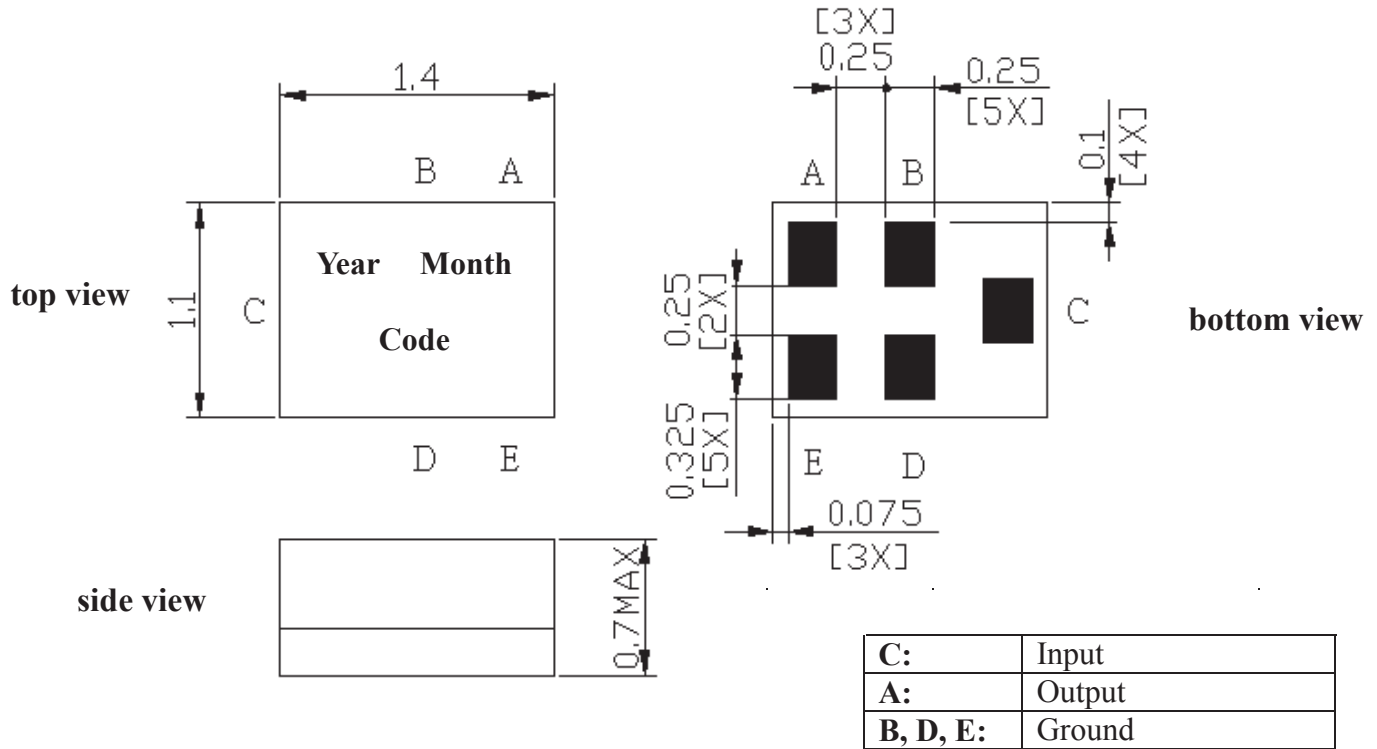

*All Dimensions are in mm

Recommended Land Pattern:

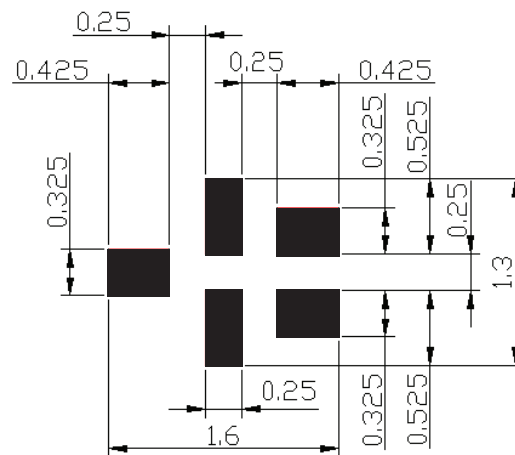

■ : Land Pattern

Unit : mm

Surface Mount 2436.00MHz SAW Filter

AFS14A72-2436.00-T2



RoHS
Compliant

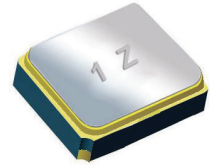

1.4 x 1.1 x 0.7 mm

FREQUENCY CHARACTERISTICS:

Filter Frequency Response (Narrowband)

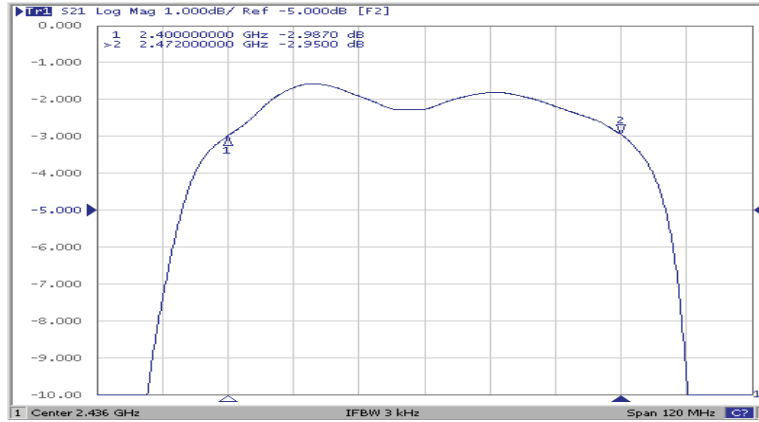

Filter Frequency Response (Wideband)

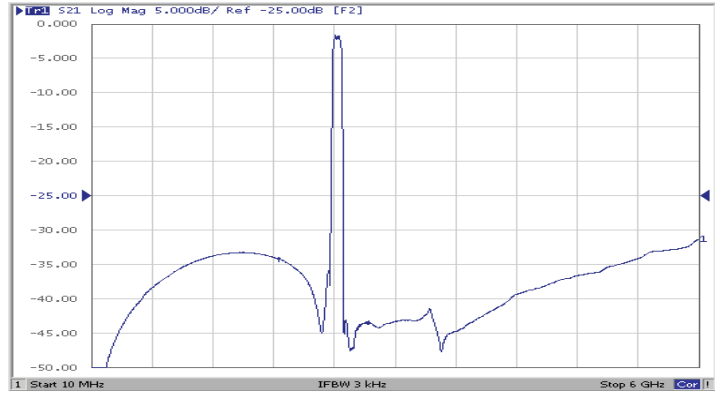
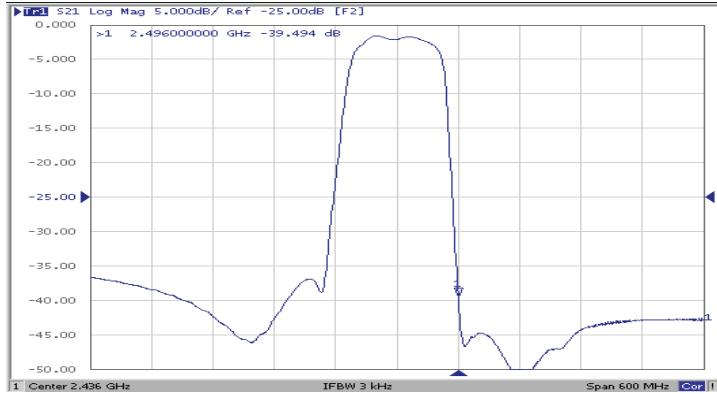

REFLECTION FUNCTIONS:

S11

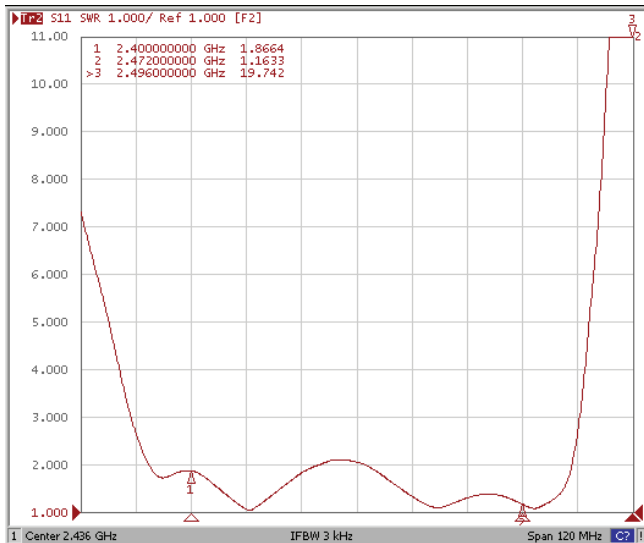

S22

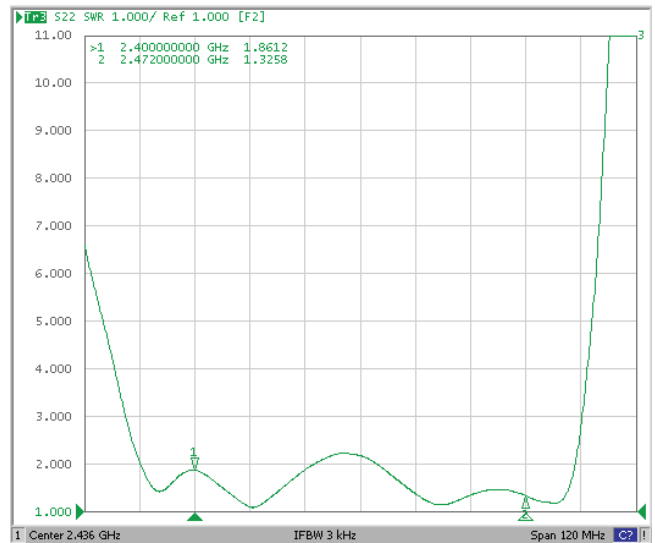

ABRACON IS
ISO 9001:2008
CERTIFIED



ABRACON
CORPORATION

Visit www.abracon.com for Terms & Conditions of Sale
30332 Esperanza, Rancho Santa Margarita, California 92688
tel 949-546-8000 | fax 949-546-8001 | www.abracon.com

Revised: 07.23.12

Surface Mount 2436.00MHz SAW Filter

AFS14A72-2436.00-T2



RoHS
Compliant

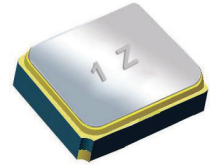

1.4 x 1.1 x 0.7 mm

REFLOW PROFILE:

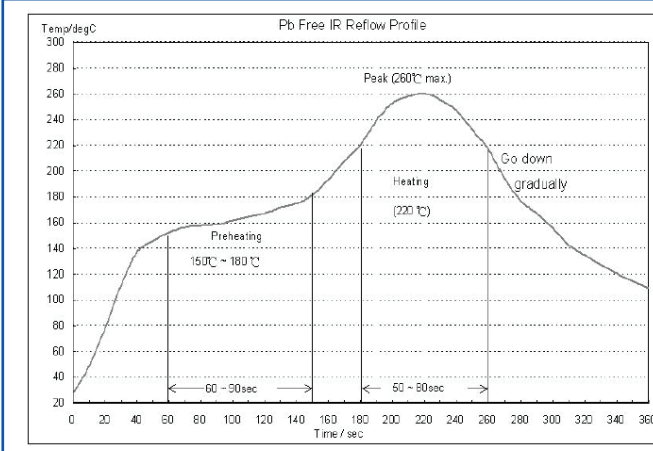

- Preheating shall be fixed at 150~180°C for 60~90 seconds.
- Ascending time to preheating temperature 150°C shall be 30 seconds min.
- Heating shall be fixed at 220°C for 50~80 seconds and at 250±10°C peak (max. 10sec). Time : 2 times

PACKAGING: 2000 Units/Reel

Reel Count : 7" = 2k units

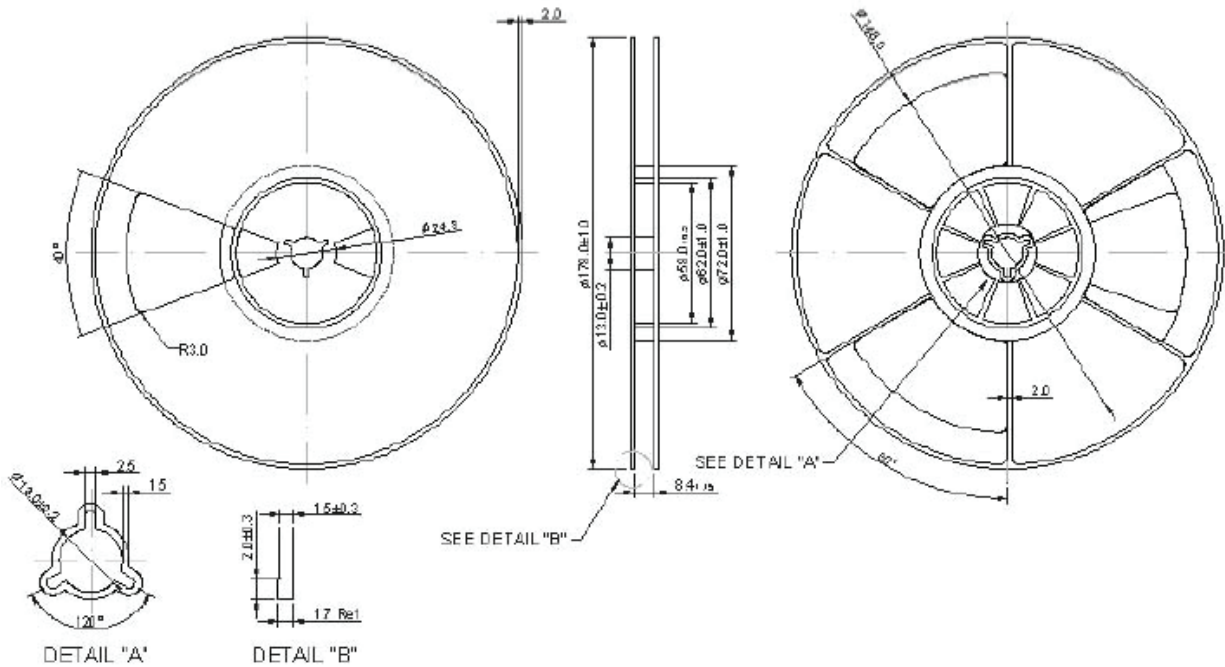

ATTENTION: Abracon Corporation's products are COTS – Commercial-Off-The-Shelf products; suitable for Commercial, Industrial and, where designated, Automotive Applications. Abracon's products are not specifically designed for Military, Aviation, Aerospace, Life-dependant Medical applications or any application requiring high reliability where component failure could result in loss of life and/or property. For applications requiring high reliability and/or presenting an extreme operating environment, written consent and authorization from Abracon Corporation is required. Please contact Abracon Corporation for more information.

ABRACON IS
ISO 9001:2008
CERTIFIED



Visit www.abracon.com for Terms & Conditions of Sale
30332 Esperanza, Rancho Santa Margarita, California 92688
tel 949-546-8000 | fax 949-546-8001 | www.abracon.com

Revised: 07.23.12