

THIS DRAWING IS UNPUBLISHED. RELEASED FOR PUBLICATION  
 © COPYRIGHT BY TYCO ELECTRONICS CORPORATION. ALL RIGHTS RESERVED.

LOC	DIST	REVISIONS			
P	LTR	DESCRIPTION	DATE	DWN	APVD
	C13	REVISED PER ECO-10-009056	09AUG10	HMR	CR

**PHYSICAL PROPERTIES:**

HOUSING MATERIAL: THERMOPLASTIC, PC  
 FLAMABILITY: UL94V-0  
 COLOR: BLACK

**TERMINAL:**

TERMINALS: BRASS, TIN PLATED  
 SCREWS: 6-32 STEEL, NICKEL PLATED

**MECHANICAL:**

PITCH: .437  
 WIRE RANGE: 14-22 AWG  
 RECOMMENDED TIGHTENING TORQUE: 12IN-LB

**ELECTRICAL PROPERTIES:**

MAX CURRENT: 25A  
 OPERATING VOLTAGE: 300V

**ENVIRONMENTAL PROPERTIES:**

OPERATING TEMP: -40°C TO 120°C

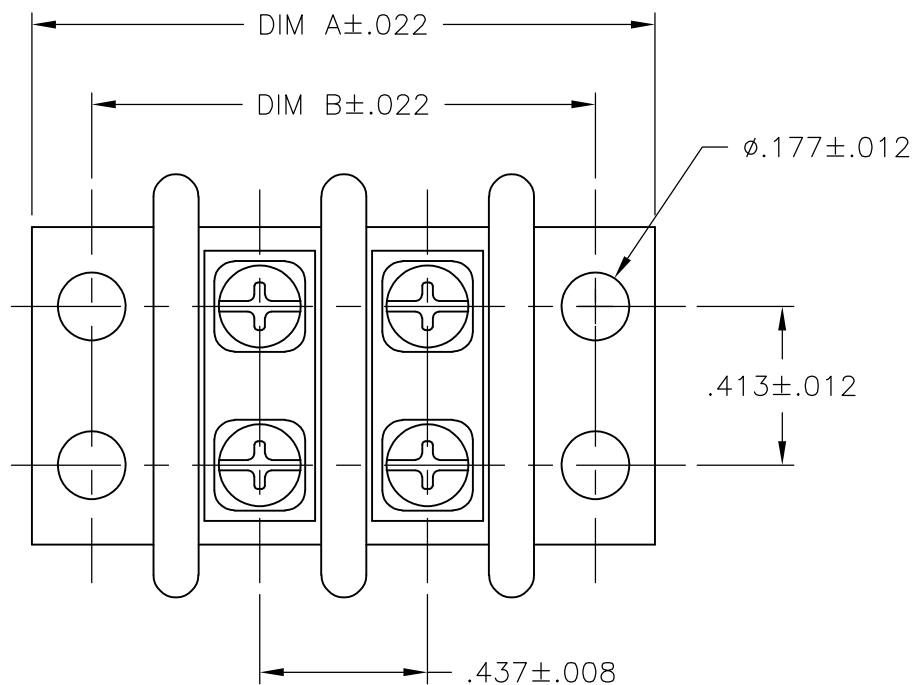

- 1 MARKED WITH WHITE INK APPROX AS SHOWN.
- 2 SEE FIGURE.
- 3 PRELIMINARY PART NUMBER.
- 4 TE LOGO LOCATED APPROXIMATE AREA SHOWN.

11.764	12.110	26	2-1546671-6
11.327	11.673	25	2-1546671-5
10.90	11.236	24	2-1546671-4
10.453	10.799	23	2-1546671-3
10.016	10.362	22	2-1546671-2
9.579	9.925	21	2-1546671-1
9.142	9.488	20	2-1546671-0
8.705	9.051	19	1-1546671-9
8.268	8.614	18	1-1546671-8
7.831	8.177	17	1-1546671-7
7.394	7.740	16	3-1546671-0
7.394	7.740	16	2-1546671-9
7.394	7.740	16	1-1546671-6
6.957	7.303	15	1-15464671-5
6.520	6.866	14	2-1546671-8
6.520	6.866	14	1-1546671-4
6.083	6.429	13	1-1546671-3
5.646	5.992	12	1-1546671-2
5.209	5.555	11	1-1546671-1
4.772	5.118	10	1-1546671-0
4.335	4.681	9	2-1546671-7
4.335	4.681	9	1546671-9
3.898	4.244	8	1546671-8
3.461	3.807	7	1546671-7
3.024	3.370	6	3-1546671-1
3.024	3.370	6	1546671-6
2.587	2.933	5	1546671-5
2.150	2.496	4	1546671-4
1.713	2.059	3	1546671-3
1.276	1.622	2	1546671-2
DIM B	DIM A	NO OF POS	PART NUMBER

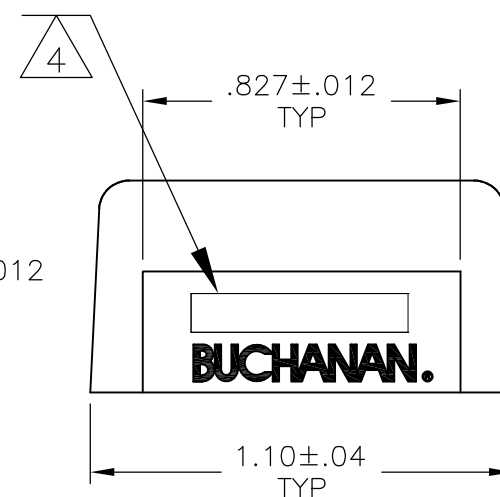
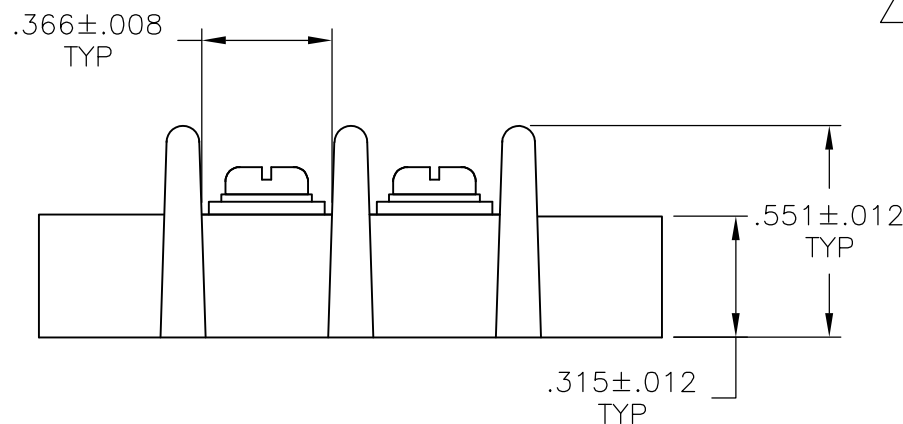

THIS DRAWING IS A CONTROLLED DOCUMENT.		DWN S SCHEGEL 4/4/03	Tyco Electronics Corporation Harrisburg, PA 17105-3608	
DIMENSIONS: INCHES		CHK C RICHARD 4/4/03	NAME DOUBLE ROW BARRIER STRIP W/ WIRE CLAMP, .437 SPACING	
TOLERANCES UNLESS OTHERWISE SPECIFIED:		APVD C RICHARD 4/4/03	PRODUCT SPEC	
0 PLC ± - 1 PLC ± - 2 PLC ± .01 3 PLC ± .005 4 PLC ± - ANGLES ± 2°		APPLICATION SPEC		
MATERIAL -		WEIGHT -	SIZE A3	CAGE CODE 00779
FINISH -		DRAWING NO C-1546671		RESTRICTED TO -
CUSTOMER DRAWING			SCALE NTS	SHEET 1 OF 3
			REV C13	

THIS DRAWING IS UNPUBLISHED. RELEASED FOR PUBLICATION  
 © COPYRIGHT - BY TYCO ELECTRONICS CORPORATION. ALL RIGHTS RESERVED.

LOC	DIST	REVISIONS					
FT	0	P	LTR	DESCRIPTION	DATE	DWN	APVD
				SEE SHEET 1	-	-	-

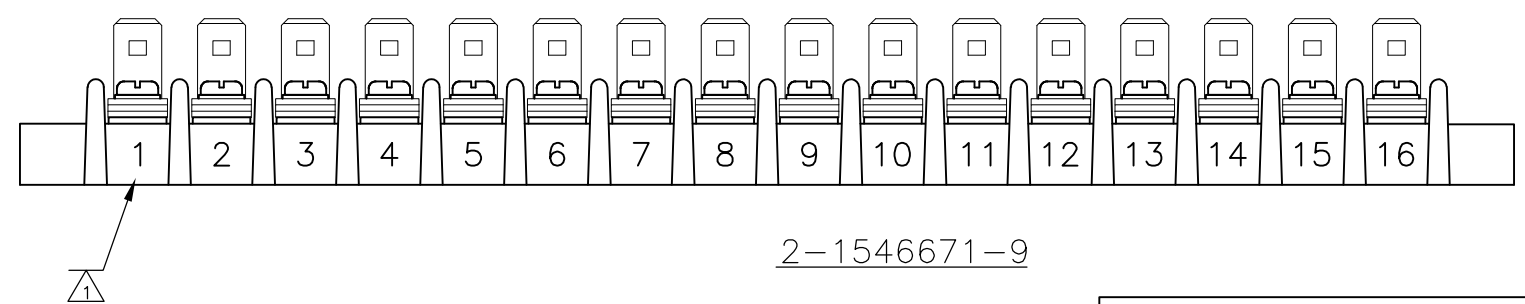
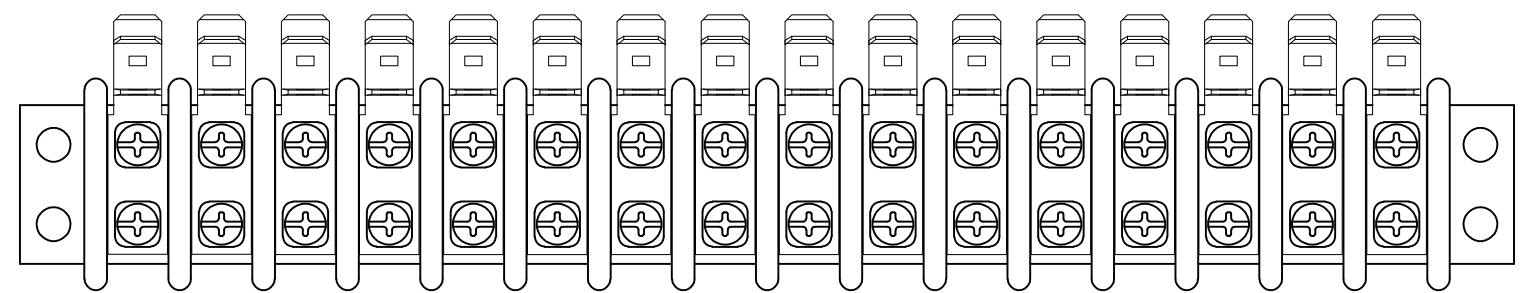
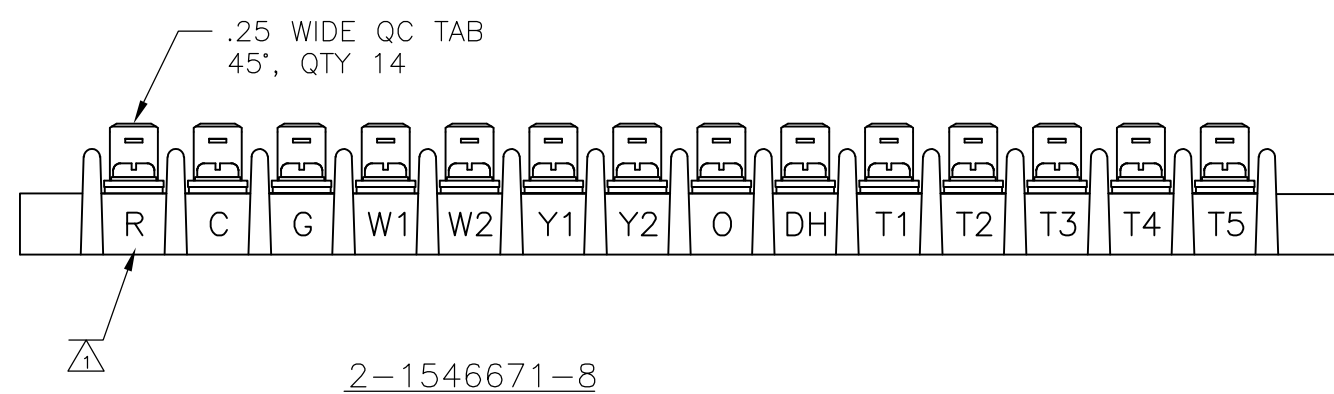
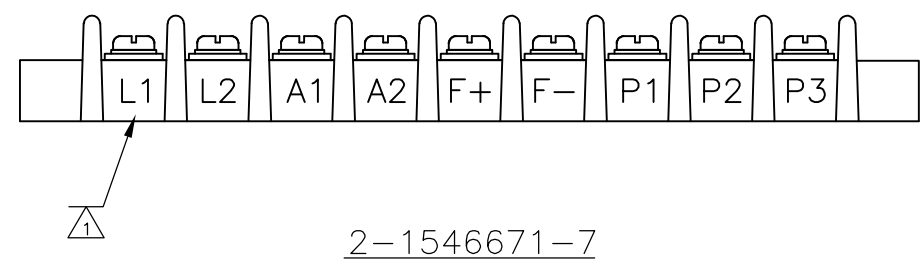

THIS DRAWING IS A CONTROLLED DOCUMENT.		DWN	S SCHEGEL	4/4/03	Tyco Electronics Corporation Harrisburg, PA 17105-3608				
DIMENSIONS: INCHES		CHK	C RICHARD	4/4/03	NAME DOUBLE ROW BARRIER STRIP W/ WIRE CLAMP, .437 SPACING				
TOLERANCES UNLESS OTHERWISE SPECIFIED:		APVD	C RICHARD	4/4/03	PRODUCT SPEC	SIZE	CAGE CODE	DRAWING NO	RESTRICTED TO
0 PLC ± -		APPLICATION SPEC			—	—	—	—	—
1 PLC ± -		WEIGHT			—	A3	00779	C-1546671	—
2 PLC ± .01		CUSTOMER DRAWING		SCALE	NTS	SHEET	2 OF 3	REV	C13
3 PLC ± .005									
4 PLC ± -									
ANGLES ± 2'									
MATERIAL									
FINISH									

THIS DRAWING IS UNPUBLISHED. RELEASED FOR PUBLICATION

© COPYRIGHT BY TYCO ELECTRONICS CORPORATION. ALL RIGHTS RESERVED.

LOC FT DIST 0

REVISIONS

P	LTR	DESCRIPTION	DATE	DWN	APVD
-	-	SEE SHEET 1	-	-	-

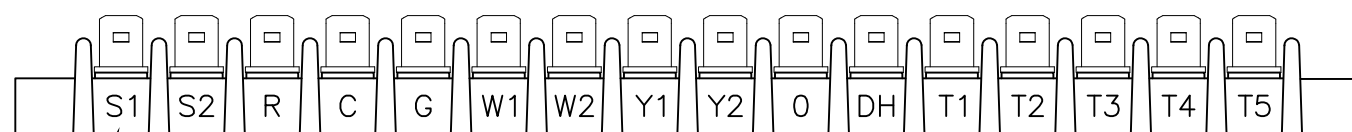
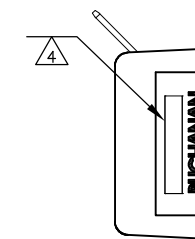
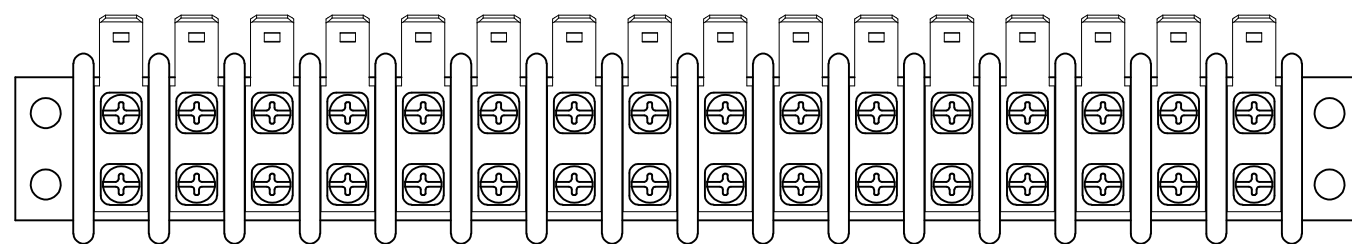

3-1546671-0

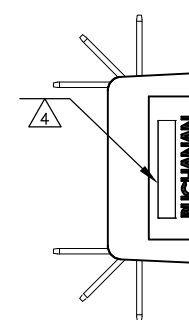
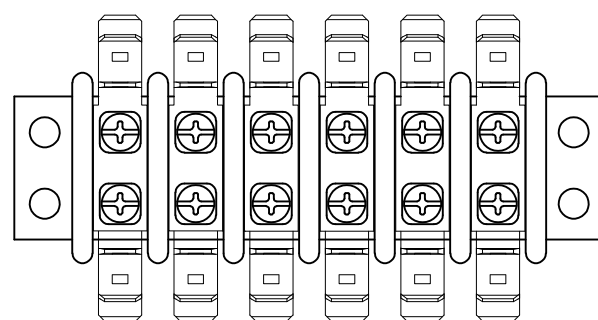
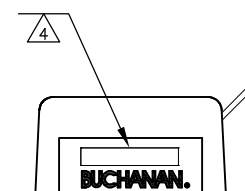

3-1546671-1

THIS DRAWING IS A CONTROLLED DOCUMENT.

DIMENSIONS:  
INCHES

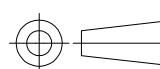

TOLERANCES UNLESS OTHERWISE SPECIFIED:

0 PLC	± -
1 PLC	± -
2 PLC	± .01
3 PLC	± .005
4 PLC	± -
ANGLES	± 2'

MATERIAL

FINISH

DWN S SCHEGEL 4/4/03

CHK C RICHARD 4/4/03

APVD C RICHARD 4/4/03

PRODUCT SPEC

APPLICATION SPEC

WEIGHT -

CUSTOMER DRAWING



Tyco Electronics Corporation  
Harrisburg, PA 17105-3608

NAME  
DOUBLE ROW BARRIER STRIP W/ WIRE CLAMP,  
.437 SPACING

SIZE	CAGE CODE	DRAWING NO	RESTRICTED TO
A3	00779	C-1546671	-

SCALE NTS SHEET 3 OF 3 REV C13