

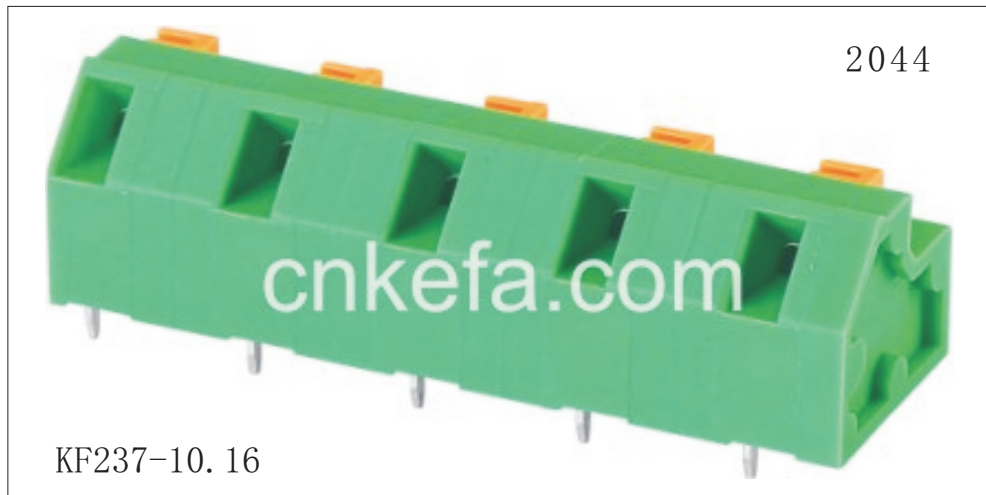

# 慈溪市科发电子有限公司



## CIXI KEFA ELECTRONICS CO., LTD.

产品规格书

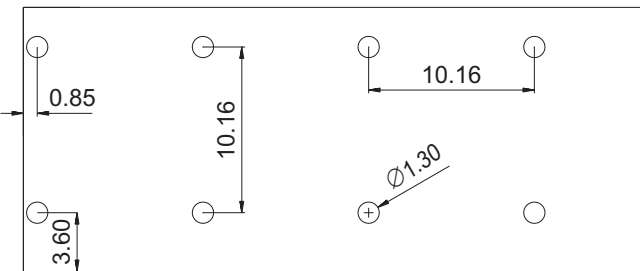
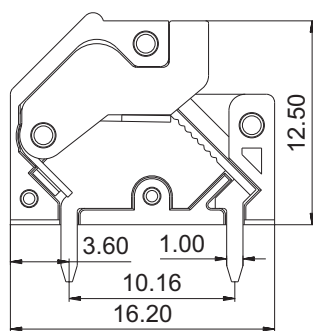
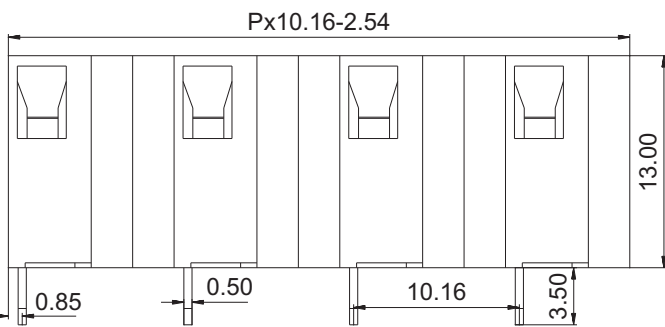

KF237-10.16



| 认证   |      |  |  |
|------|------|---|---|
| 电气性能 | 参考标准 | UL  | IEC   |
|      | 额定电压 | 300V  | 750V  |
|      | 额定电流 | 10A   | 10A   |
|      | 使用线径 | 22-16 AWG   | 1.5mm <sup>2</sup>  |
| 耐电压  |      | AC2000V/1Min  |   |

| 机械性能 |            |
|------|------------|
| 温度范围 | -40℃—+105℃ |
| 剥线长度 | 10.0mm     |

| 尺寸 |         |
|----|---------|
| 间距 | 10.16mm |
| 极数 | 1P-x xP |

| 材质及电镀 |              |
|-------|--------------|
| 塑体    | PA66 UL94V-0 |
| 焊针    | 磷铜 镀锡        |
| 弹片    | 不锈钢          |

订购方式:

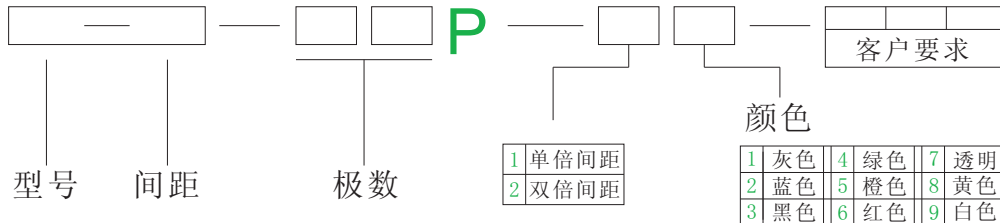

|  |   |   |
|--|---|---|
|                           |  | <b>慈溪市科发电子有限公司</b><br>CIXI KEFA ELECTRONICS CO., LTD. |
| <br>THIROANGIF PROJECTION | <b>NAME</b>   | KF237-10.16   |