

## Features

- For Detector and Mixer Applications
- Low Capacitance for Usage Beyond 40 GHz
- ZBD and Low Barrier Designs
- P-Type and N-Type Junctions
- Large Bond Pad Chip Design

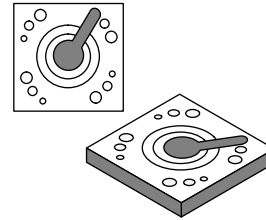

## Description

Alpha's product line of silicon Schottky diode chips are intended for use as detector and mixer devices in hybrid integrated circuits at frequencies from below 100 MHz to higher than 40 GHz. Alpha's "Universal Chip" design features a 4 mil diameter bond pad that is offset from the semiconductor junction preventing damage to the active junction as a result of wire bonding.

As power-sensing detectors, these Schottky diode chips all have the same voltage sensitivity so long as the output video impedance is much higher than the video resistance of the diode. Figure 1 shows the expected detected voltage sensitivity as a function of RF source impedance in an untuned circuit. Note that sensitivity is substantially increased by transforming the source impedance from 50  $\Omega$  to higher values. Maximum sensitivity occurs when the source impedance equals the video resistance.

In a detector circuit operating at zero bias, depending on the video load impedance, a ZBD device with  $R_V$  less than 10 k $\Omega$  may be more sensitive than a low barrier diode with  $R_V$  greater than 100 k $\Omega$ . Applying forward bias reduces the diode video resistance as shown in Figure 2. Lower video resistance also increases the video bandwidth but does not increase voltage sensitivity, as shown in Figure 3. Biased Schottky diodes have better temperature stability and also may be used in temperature compensated detector circuits.

P-type Schottky diodes generate lower 1/F noise and are preferred for Doppler mixers and biased detector applications. The bond pad for the P-type Schottky diode is the cathode. N-type Schottky diodes have lower parasitic resistance,  $R_S$ , and will perform with lower conversion loss in mixer circuits. The bond pad for the N-type Schottky diode is the anode.

## Electrical Specifications at 25°C

Part Number	Barrier	Junction Type	$C_J^1$	$R_T^2$	$V_F @ 1 \text{ mA}$	$V_B^3$	$R_V @ \text{Zero Bias}$	Outline Drawing
			(pF)	( $\Omega$ )	(mV)	(V)	(k $\Omega$ )	
			Max.	Max.	Min.–Max.	Min.	Typ.	
CDC7630-000	ZBD	P	0.25	30	135–240	1	5.5	526-006
CDC7631-000	ZBD	P	0.15	80	150–300	2	7.2	526-006
CDB7619-000	Low	P	0.10	40	275–375	2	735	526-006
CDB7620-000	Low	P	0.15	30	250–350	2	537	526-006
CDF7621-000	Low	N	0.10	20	270–350	2	680	526-011
CDF7623-000	Low	N	0.30	10	240–300	2	245	526-011

1.  $C_J$  for low barrier diodes specified at 0 V.  $C_J$  for ZBDs specified at 0.15 V reverse bias.

2.  $R_T$  is the slope resistance at 10 mA.  $R_S$  Max. may be calculated from:  
 $R_S = R_T - 2.6 \times N$ .

3.  $V_B$  for low barrier diodes is specified at 10  $\mu$ A.  $V_B$  for ZBDs is specified at 100  $\mu$ A.

## Typical Performance Data

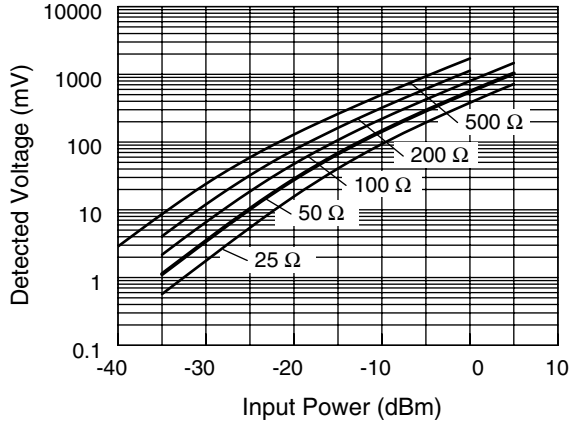
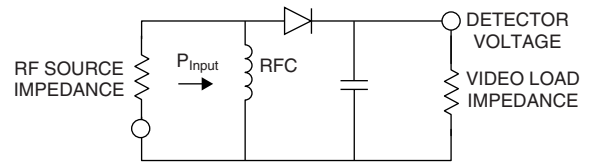
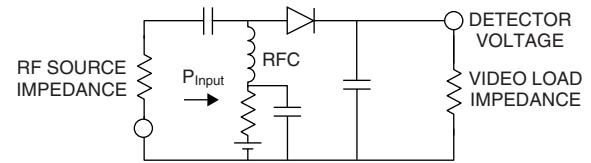

Figure 1. Detected Voltage vs. Input Power and RF Source Impedance



Zero Biased Detector



Biased Detector

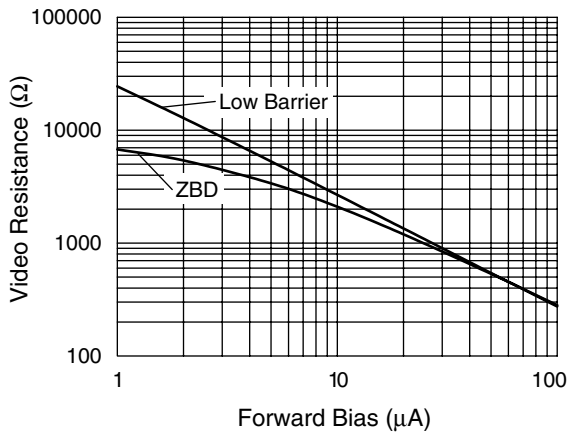

Figure 2. Video Resistance vs. Forward Bias Current

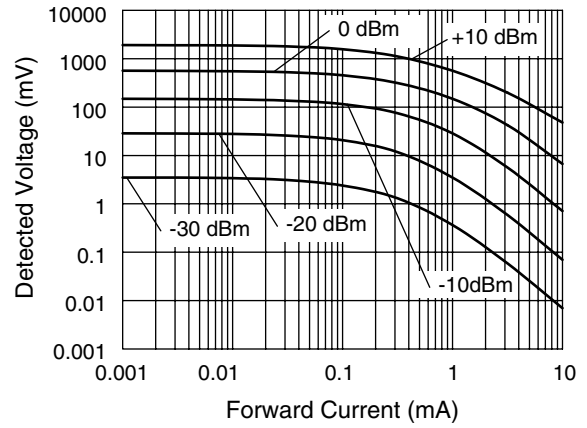
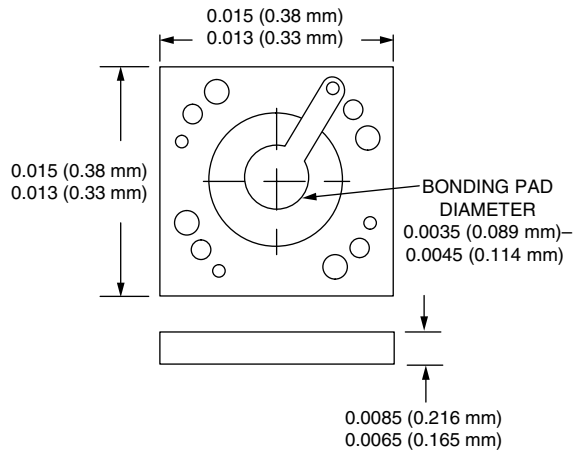

Figure 3. Detected Voltage vs. Forward Current

## SPICE Model Parameters

Parameter	CDB7619	CDB7620	CDF7621	CDF7623	CDC7630	CDC7631	Units
IS	3.70E-08	5.40E-08	4.0E-08	1.1E-07	5.0E-06	3.8E-06	A
RS	9	14	12	6	20	51	Ω
N	1.05	1.12	1.05	1.04	1.05	1.05	
TT	1E-11	1E-11	1E-11	1E-11	1E-11	1E-11	S
CJO	0.08	0.15	0.10	0.22	0.14	0.08	pF
M	0.35	0.35	0.35	0.32	0.40	0.4	
EG	0.69	0.69	0.69	0.69	0.69	0.69	eV
XTI	2.0	2.0	2.0	2.0	2.0	2.0	
FC	0.5	0.5	0.5	0.5	0.5	0.5	
BV	2.0	4.0	3.0	2.0	2.0	2.0	V
IBV	1.00E-05	1.00E-05	1.0E-05	1.0E-05	1.0E-04	1.0E-04	A
VJ	0.495	0.495	0.495	0.495	0.340	0.340	V

**Outline Drawing**  
526-006, 526-011



526-006 = Cathode bond pad.  
526-011 = Anode bond pad.

**Absolute Maximum Ratings**

Characteristic	Value
Reverse Voltage ( $V_R$ )	Voltage Rating
Forward Current ( $I_F$ )	50 mA
Power Dissipation ( $P_D$ )	75 mW
Storage Temperature ( $T_{ST}$ )	-65°C to +150°C
Operating Temperature ( $T_{OP}$ )	-65°C to +150°C