

PNP Silicon AF Transistors

BC 807
BC 808

- For general AF applications
- High collector current
- High current gain
- Low collector-emitter saturation voltage
- Complementary types: BC 817, BC 818 (NPN)

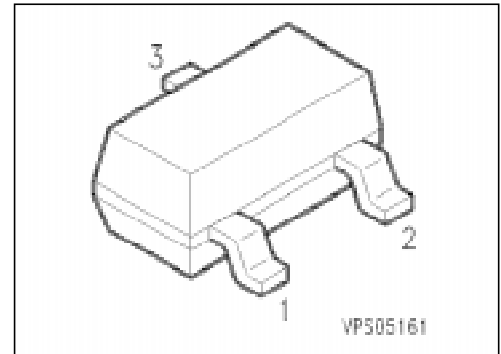

Type	Marking	Ordering Code	Pin Configuration			Package ¹⁾
			1	2	3	
BC 807-16	5As	Q62702-C1735	B	E	C	SOT-23
BC 807-25	5Bs	Q62702-C1689				
BC 807-40	5Cs	Q62702-C1721				
BC 808-16	5Es	Q62702-C1736				
BC 808-25	5Fs	Q62702-C1504				
BC 808-40	5Gs	Q62702-C1692				

¹⁾ For detailed information see chapter Package Outlines.

Maximum Ratings

Parameter	Symbol	Values		Unit
		BC 807	BC 808	
Collector-emitter voltage	V_{CE0}	45	25	V
Collector-base voltage	V_{CB0}	50	30	
Emitter-base voltage	V_{EB0}	5	5	
Collector current	I_C	500		mA
Peak collector current	I_{CM}	1		A
Base current	I_B	100		mA
Peak base current	I_{BM}	200		
Total power dissipation, $T_C = 79\text{ °C}$	P_{tot}	330		mW
Junction temperature	T_j	150		°C
Storage temperature range	T_{stg}	- 65 ... + 150		

Thermal Resistance

Junction - ambient ¹⁾	$R_{th\ JA}$	≤ 285	K/W
Junction - soldering point	$R_{th\ JS}$	≤ 215	

¹⁾ Package mounted on epoxy pcb 40 mm × 40 mm × 1.5 mm/6 cm² Cu.

Electrical Characteristics

at $T_A = 25\text{ °C}$, unless otherwise specified.

Parameter	Symbol	Values			Unit
		min.	typ.	max.	

DC characteristics

Collector-emitter breakdown voltage $I_C = 10\text{ mA}$	$V_{(BR)CE0}$				V
BC 807		45	–	–	
BC 808		25	–	–	
Collector-base breakdown voltage $I_C = 100\text{ }\mu\text{A}$	$V_{(BR)CB0}$				
BC 807		50	–	–	
BC 808		30	–	–	
Emitter-base breakdown voltage, $I_E = 10\text{ }\mu\text{A}$	$V_{(BR)EB0}$	5	–	–	
Collector cutoff current $V_{CB} = 25\text{ V}$ $V_{CB} = 25\text{ V}, T_A = 150\text{ °C}$	I_{CB0}				nA μA
		–	–	100	
		–	–	50	
Emitter cutoff current, $V_{EB} = 4\text{ V}$	I_{EB0}	–	–	100	nA
DC current gain ¹⁾ $I_C = 100\text{ mA}; V_{CE} = 1\text{ V}$	h_{FE}				–
BC 807-16, BC 808-16		100	160	250	
BC 807-25, BC 808-25		160	250	400	
BC 807-40, BC 808-40		250	350	630	
$I_C = 300\text{ mA}; V_{CE} = 1\text{ V}$					
BC 807-16, BC 808-16		60	–	–	
BC 807-25, BC 808-25		100	–	–	
BC 807-40, BC 808-40		170	–	–	
Collector-emitter saturation voltage ¹⁾ $I_C = 500\text{ mA}; I_B = 50\text{ mA}$	V_{CEsat}	–	–	0.7	V
Base-emitter saturation voltage ¹⁾ $I_C = 500\text{ mA}; I_B = 50\text{ mA}$	V_{BEsat}	–	–	2	

AC characteristics

Transition frequency $I_C = 50\text{ mA}, V_{CE} = 5\text{ V}, f = 20\text{ MHz}$	f_T	–	200	–	MHz
Output capacitance $V_{CB} = 10\text{ V}, f = 1\text{ MHz}$	C_{obo}	–	10	–	pF
Input capacitance $V_{EB} = 0.5\text{ V}, f = 1\text{ MHz}$	C_{ibo}	–	60	–	

¹⁾ Pulse test: $t \leq 300\text{ }\mu\text{s}, D \leq 2\%$.

Total power dissipation $P_{tot} = f(T_A^*; T_S)$

* Package mounted on epoxy

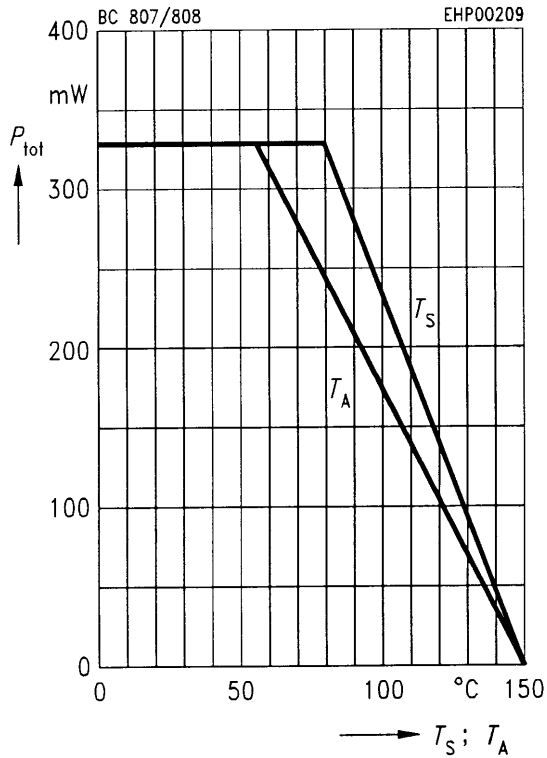

Transition frequency $f_T = f(I_C)$

$V_{CE} = 5 V$

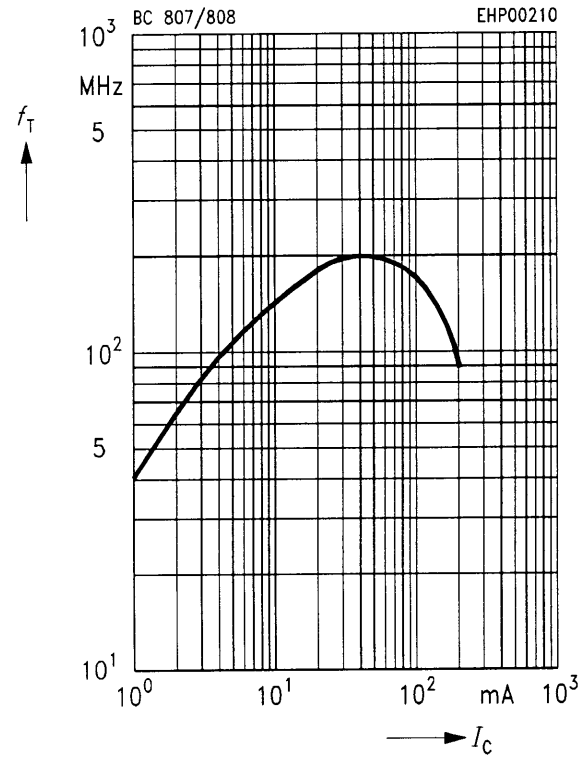

Permissible pulse load $P_{tot max}/P_{tot DC} = f(t_p)$

Collector cutoff current $I_{CB0} = f(T_A)$

$V_{CB0} = 25 V$

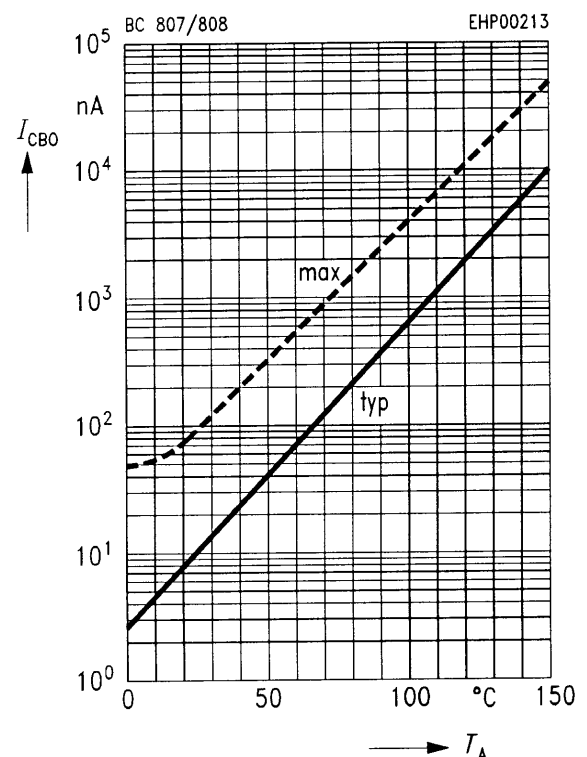
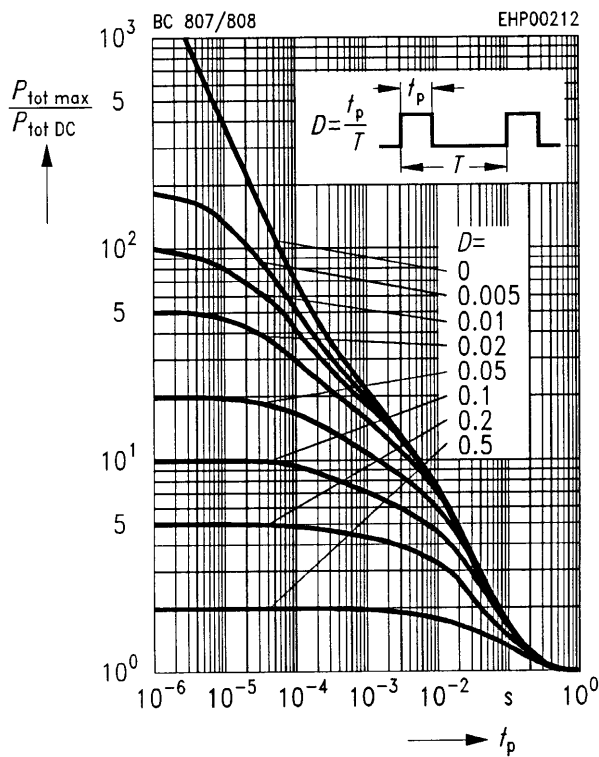

Base-emitter saturation voltage

$$I_C = f(V_{BEsat})$$

$$h_{FE} = 10$$

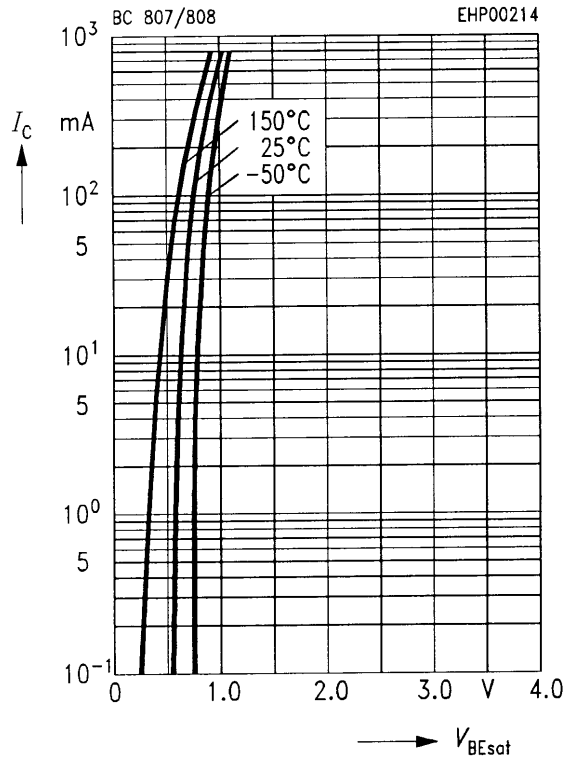

Collector-emitter saturation voltage

$$I_C = f(V_{CEsat})$$

$$h_{FE} = 10$$

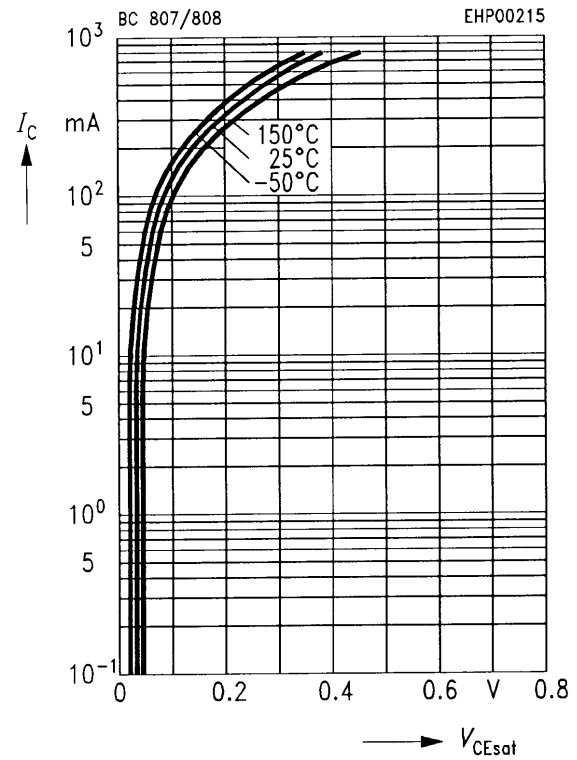

DC current gain $h_{FE} = f(I_C)$

$$V_{CE} = 1 \text{ V}$$

