

Part Number: PDC54-12YWA

YELLOW

### Features

- 0.54 INCH CHARACTER HEIGHT.
- LOW CURRENT OPERATION.
- HIGH CONTRAST AND LIGHT OUTPUT.
- EASY MOUNTING ON P.C. BOARDS OR SOCKETS.
- CATEGORIZED FOR LUMINOUS INTENSITY.
- MECHANICALLY RUGGED.
- STANDARD: GRAY FACE, WHITE SEGMENT.
- RoHS COMPLIANT.

### Description

The Yellow source color devices are made with Gallium Arsenide Phosphide on Gallium Phosphide Yellow Light Emitting Diode.

### Package Dimensions & Internal Circuit Diagram

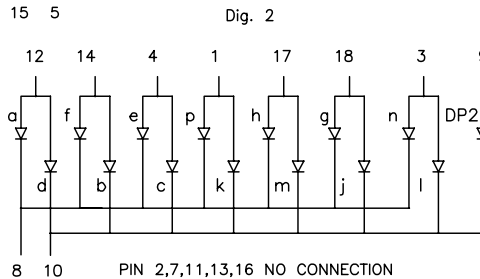
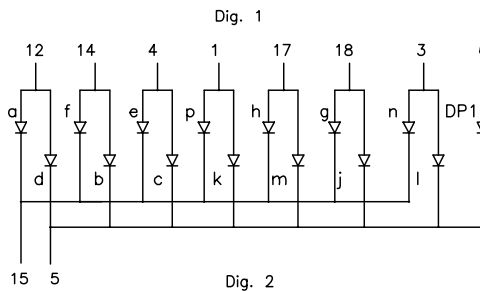
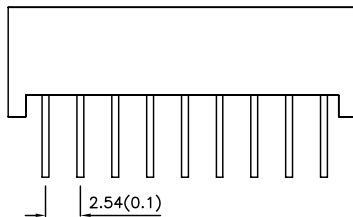
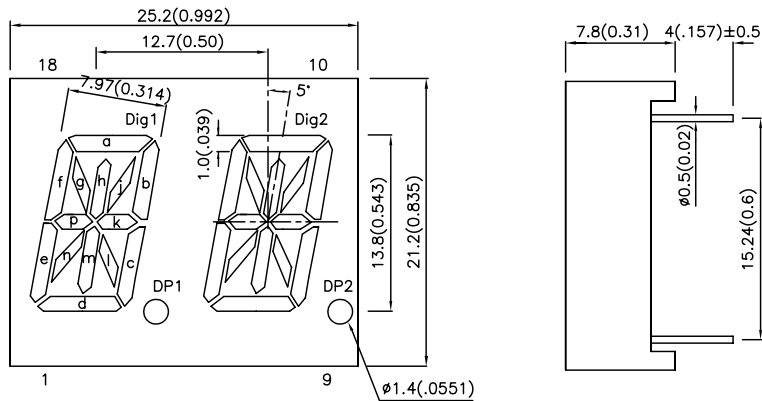

**Notes:**

1. All dimensions are in millimeters (inches), Tolerance is  $\pm 0.25(0.01)$  unless otherwise noted.
2. Specifications are subject to change without notice.

## Selection Guide

Part No.	Dice	Lens Type	Iv (ucd) [1] @ 10mA		Description
			Min.	Typ.	
PDC54-12YWA	YELLOW (GaAsP/GaP)	WHITE DIFFUSED	800	3000	Common Cathode ,Rt. Hand Decimal.

Note:

1. Luminous Intensity/ Luminous Flux: +/-15%.

## Electrical / Optical Characteristics at TA=25°C

Symbol	Parameter	Device	Typ.	Max.	Units	Test Conditions
$\lambda_{peak}$	Peak Wavelength	Yellow	590		nm	IF=20mA
$\lambda_D$ [1]	Dominant Wavelength	Yellow	588		nm	IF=20mA
$\Delta\lambda_{1/2}$	Spectral Line Half-width	Yellow	35		nm	IF=20mA
C	Capacitance Per Segment or DP	Yellow	20		pF	VF=0V;f=1MHz
VF [2]	Forward Voltage Per Segment or DP	Yellow	2.1	2.5	V	IF=20mA
IR	Reverse Current Per Segment or DP	Yellow		10	uA	VR = 5V

Notes:

1. Wavelength: +/-1nm.
2. Forward Voltage: +/-0.1V.

## Absolute Maximum Ratings at TA=25°C

Parameter	Yellow	Units
Power dissipation Per Segment or DP	105	mW
DC Forward Current Per Segment or DP	30	mA
Peak Forward Current [1] Per Segment or DP	140	mA
Reverse Voltage Per Segment or DP	5	V
Operating / Storage Temperature	-40°C To +85°C	
Lead Solder Temperature [2]	260°C For 3 Seconds	

Notes:

1. 1/10 Duty Cycle, 0.1ms Pulse Width.
2. 2mm below package base.

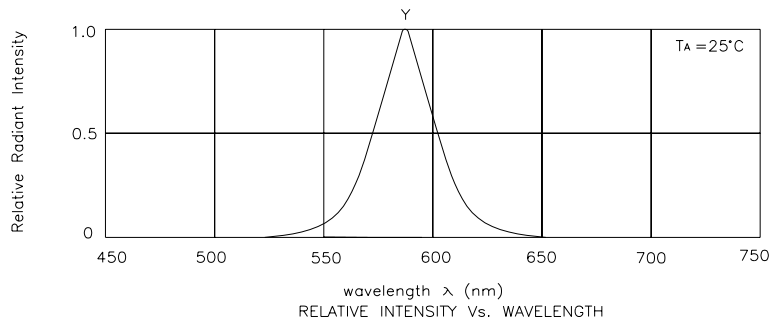

Yellow

PDC54-12YWA

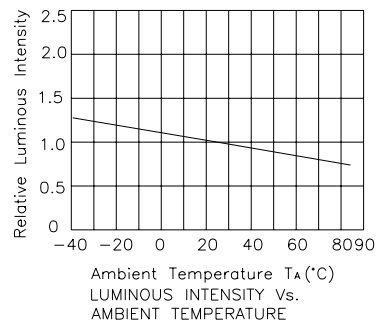
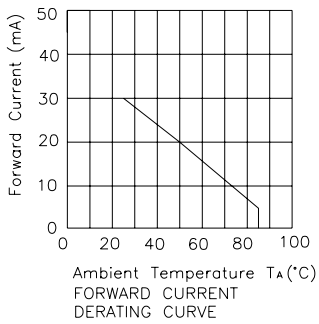
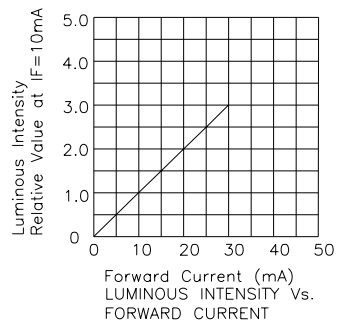
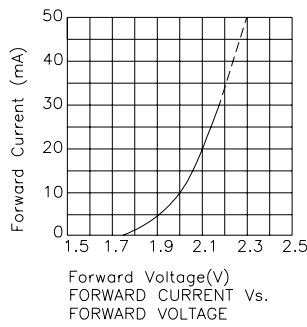

## PACKING & LABEL SPECIFICATIONS

## PDC54-12YWA

