

Major League Electronics .100 cl Box Connector Socket Strip - Vertical

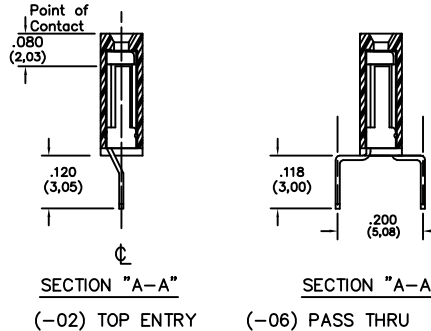

Tails may be clipped to achieve desired pin length

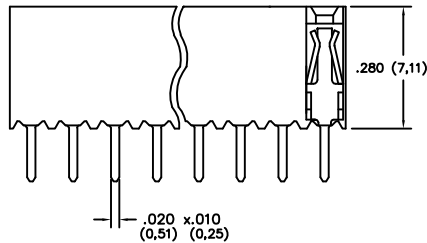
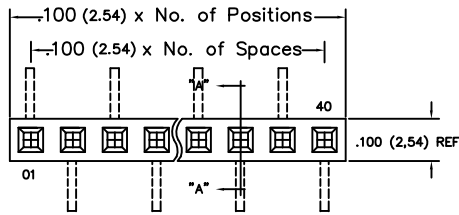
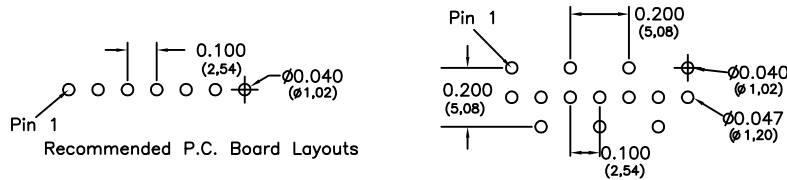

Ordering Information

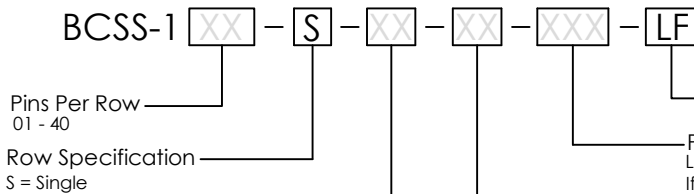

Pin Style	
Top Entry	02
Pass Thru Entry	06

Plating Options	
H	- 30µ Gold on Contact Area / Matte Tin on Tail
T	- Matte Tin All Over
GT	- 10µ Gold on Contact Area / Matte Tin on Tail
F	- Gold Flash over Entire Pin
G	- 10µ Gold on Contact area / Flash on Tail

Specifications

- Insertion Depth: .145 (3,68) to .250 (6,35)
- Insertion Force - Per Contact - H Plating: 5oz. (1,39N) avg with .025 (0,64mm) sq. pin
- Withdrawal Force - Per Contact - H Plating: 3oz. (0,83N) avg with .025 (0,64mm) sq. pin
- Current Rating: 3.0 Ampere
- Insulation Resistance: 1000MΩ Min.
- Dielectric Withstanding: 600V AC
- Contact Resistance: 20 mΩ Max.
- Operating Temperature: -40°C to + 105°C
- Max. Process Temperature:
 - Peak: 260°C up to 10 secs.
 - Process: 230°C up to 60 secs.
 - Wave: 260°C up to 6 secs.
 - Manual Solder: 350°C up to 5 secs.

Materials

- Contact Material: Phosphor Bronze
- Insulator Material: Nylon 6T
- Plating: Au or Sn over 50µ" (1,27) Ni

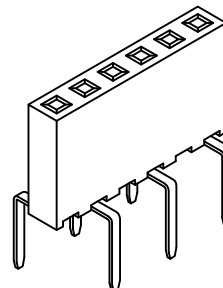

Mates with:

- BSTC, TSHCR,
- BSTCM, TSHCRE,
- BSTCR, TSHCRSM,
- BSTCRSM, TSHR,
- BSTS, TSHRE,
- LBSTCM, TSHS,
- LTSHCR, TSHSCM,
- LTSHCRE, TSHSM,
- LTSHR, ULTSHSM,
- LTSHRE, ULTSHC,
- LTSHSM, ULTHSCR
- TSHC,

Products cut to specific sizes are uncancellable/nonreturnable

Parts are subject to change without notice

BCSS-1-SV SERIES	.100 cl Single Row Box Connector Socket Strip - Vertical	12 JAN 07	Scale NTS
<small>UNLESS OTHERWISE SPECIFIED DIMENSIONS IN INCHES (MM) TOLERANCES ARE: ONE PLACE DECIMALS ±.100 TWO PLACE DECIMALS ±.010 THREE PLACE DECIMALS ±.005 FOUR PLACE DECIMALS ±.0020 ANGLES 35°</small>		4235 Earnings Way, New Albany, Indiana, 47150, USA 1-800-782-3486 (USA/Canada/Mexico) Tel: 812-944-7244 Fax: 812-944-7268 E-mail: mle@mlelectronics.com Web: www.mlelectronics.com	
		Revision C	

Revisions

Revision B - (16th Sept 2008)

Body height changed from .280 (7.11) to .335 (8.51)

Revision C - (17th Oct 2008)

Body height changed back to .280 (7.11) in line with the release of TBCSS-1-SV which now features the .335 (8.51) body height

	BCSS-1-SV SERIES	.100 cl Single Row Box Connector Socket Strip - Vertical	12 JAN 07	Scale NTS
<small>UNLESS OTHERWISE SPECIFIED DIMENSIONS IN INCHES (MM) TOLERANCES ARE: ONE PLACE DECIMALS ±.100 TWO PLACE DECIMALS ±.010 THREE PLACE DECIMALS ±.005 FOUR PLACE DECIMALS ±.0020 ANGLES ±.5°</small>		4235 Earnings Way, New Albany, Indiana, 47150, USA 1-800-782-3486 (USA/Canada/Mexico) Tel: 812-944-7244 Fax: 812-944-7268 E-mail: mle@mlelectronics.com Web: www.mlelectronics.com	Revision C	Sheet 2/2