

深圳市业展电子有限公司

承认书

SPECIFICATION FOR APPROVAL

客户名称
Customer Name _____
客户料号
Customer P/N _____
产品名称
Product Name Ultra Low Ohm Chip Resistors – YLR-W Series
制造商料号
Manufacture P/N YLR12-3-5F-W
申请承认日期
Apply Date 2019-07-02 版本
REV. _____

供货商属性 代理商 _____ 制造商 深圳市业展电子有限公司
Vendor Type Agency Manufacturer

Note: 禁止使用 1 级环境管理物质.遵守 ACBEL"环境管理物质规范"中所要求之含量标准.
Restrict use of hazardous substances of level 1; Comply with "Specification for Hazardous Substances and Materials Management" of ACBEL

供货商印鉴 Vendor Stamp	APPROVED	CHECKED	PREPARED	承认印鉴 Stamp
			邓小辉	

Mainland China: 深圳市业展电子有限公司
Shenzhen Yezhan Electronics Co., Ltd.
Add: 深圳市龙华区观澜环观中路荣倡工业园 6-7 栋
Tel: 0755-26517682 Fax: 0755-29500756

深圳市业展电子有限公司
Shenzhen Yezhan Electronics Co.,Ltd

电流采样晶片电阻 Ultra Low Ohm Chip Resistors

★特征 Features

- 阻值范围 Resistance value: 0.5mΩ~51mΩ
- 精度 Tolerance: ±1%、±2%、±5%
- 功率 Power: 2W 3W
- 温度系数 Temperature coefficient : ±50ppm/°C ,
- 工作温度范围 Operating temperature range: -65°C~170°C
- 定做特殊规格 Customized special specification size



★用途 Applications

- 过流保护 Over current protection
- 电流取样 Current sense applications
- 伺服电机控制电路 Servo motor control circuits
- 智能功率模块 Intelligent power modules
- 工业电脑模块及精密测量系统 industrial PC modules and precision measurement system
- 高速 CPU 外围设备中电流检测电路 Current detection circuits in high-speed CPU peripherals

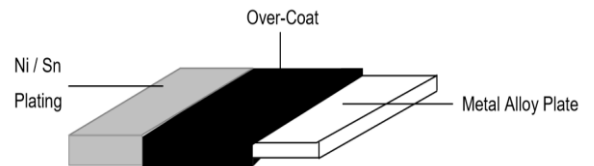

★尺寸 Size

Type	L /mm	W /mm	A /mm	D /mm	resistance /mΩ
2512	6.35±0.2	3.2±0.2	1.7±0.2 0.9±0.2	0.8±0.1	≤4 >4

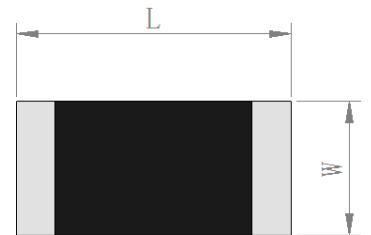

★推荐焊接尺寸 Recommend Solder Pad Dimension

Resistance range /mΩ	Dimensions		
	a/mm	b/mm	L/mm
≤4	4.0	3.1	1.3
>4		2.1	4.1

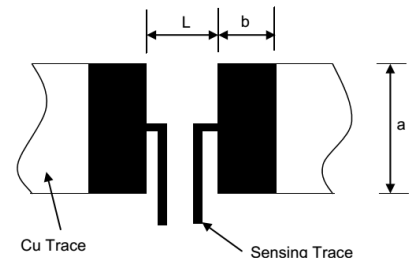

★印字标识 Marking

R001=1mΩ R050=50mΩ

深圳市业展电子有限公司
Shenzhen Yezhan Electronics Co.,Ltd

电流采样晶片电阻
Ultra Low Ohm Chip Resistors

★工作特性 Performance Characteristics

Items	Additional Requirements	Reference	Limits
Temperature Cycling	1000 Cycles(-55℃ to +125℃) Measurement at 24±2hours after test conclusion	JESD22 Method JA-104	±0.5%
High Temperature Exposure	1000hrs.@T=125℃.Unpowered. Measurement at 24±2hours after test conclusion	MIL-STD-202 Method 108	±1%
Moisture Resistance	t=24hrs/cycle.Note:Steps 7a & 7b not required. Unpowered. Measurement at 24±2hours after test conclusion	MIL-STD-202 Method 106	±0.5%
Biased Humidity	1000hrs 85℃/85%RH。 Note:Specified conditions:10% of operating power. Measurement at 24±2hours after test conclusion	MIL-STD-202 Method 103	±0.5%
Operational Life	Condition D Steady State TA=125℃ at rated power. Measurement at 24±2hours after test conclusion	MIL-STD-202 Method 108	±1%
Solderability	235℃±5℃,2s±0.5s	J-STD-202	95% Coverage Minimum
Vibration	5 g's for 20 min, 12 cycles each of 3 orientations. Note: Use 8"X5" PCB .031" thick 7 secure points on one long side and 2 secure points at corners of opposite sides. Parts mounted within 2" from any secure point. Test from 10-2000 Hz. Measurement at 24±2hours after test conclusion	MIL-STD-202 Method 204	±0.5%
Resistance to Soldering Heat	260℃±5℃, 10s±1s Measurement at 24±2hours after test conclusion	MIL-STD-202 Method 210	±0.5%
Short Time Overload	5×Rated power for 5 s Measurement at 24±2hours after test conclusion	MIL-STD-202 Method 201	±0.5%

深圳市业展电子有限公司
Shenzhen Yezhan Electronics Co.,Ltd

电流采样晶片电阻 Ultra Low Ohm Chip Resistors

★功率曲线 Power Derating Curve

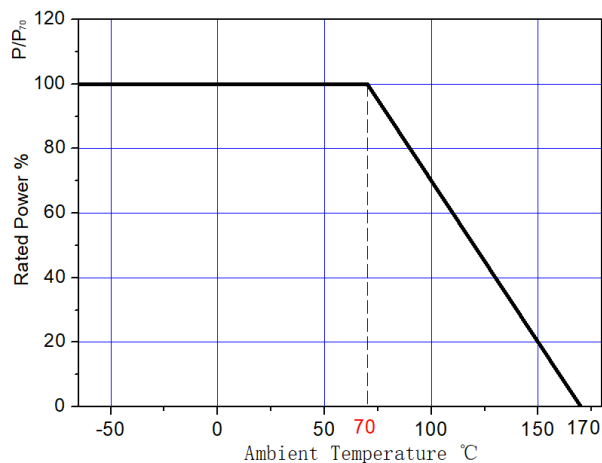

★温度系数曲线 Temperature Coefficient of Resistance Curve

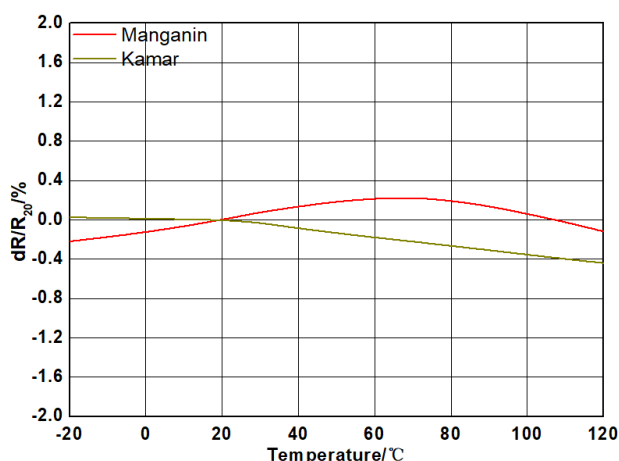

★订购信息 Ordering Date

产品型号 Model

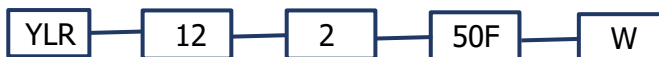

规格型号 Type

12: 2512

额定功率 Rated Power

2:2W

阻值 Resistance

50F: 50mΩ 1%精度

W: 其他

深圳市业展电子有限公司
Shenzhen Yezhan Electronics Co.,Ltd

电流采样晶片电阻 Ultra Low Ohm Chip Resistors

★包装方式 Embossed Plastic Tape Specifications

储藏条件 Storage Conditions: Temperature:5℃~35℃, Humidity:40%~75%

包装数量 Number of Package

3000 个/盘 3000 Pieces / Package

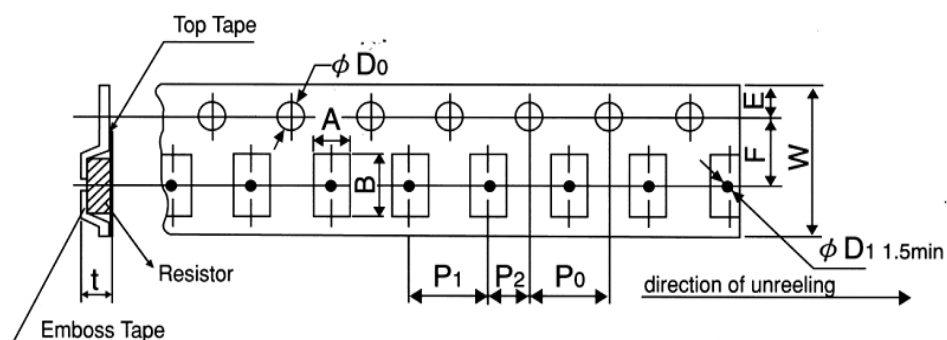

Items	Type	A	B	W	F	E	P ₁	P ₂	P ₀	D ₀	t
Size	YLR2512	3.6	6.9	12	5.5	1.75	4.0	2.0	4.0	Φ1.5	1.2