

Technical Chip Distributor for ADI Die Products

Application Support

- Design Assistance
- Assembly Assistance
- Die handling consultancy
- Hi-Rel die qualification
- Hot & Cold die probing
- Electrical test & trimming

Distributed Product Support

- Customised Pack Sizes / Qtys
- Support for all industry recognised supply formats:
 - Waffle Pack
 - Gel Pak
 - Tape & Reel
- Onsite storage, stockholding & scheduling

Product Quality Assurance

- 100% Visual Inspection
 - MIL-STD 883 Condition A
 - MIL-STD 883 Condition A
- On-site failure analysis
- Bespoke 24 Hour monitored storage systems for secure long term product support
- On-site failure analysis

Contact

baredie@micross.com

For price, delivery and to place orders

[HMC361](#)

Analog Devices Welcomes Hittite Microwave Corporation

NO CONTENT ON THE ATTACHED DOCUMENT HAS CHANGED



THIS PAGE INTENTIONALLY LEFT BLANK

Typical Applications

Prescaler for DC to X Band PLL Applications:

- Satellite Communication Systems
- Fiber Optic
- Point-to-Point and Point-to-Multi-Point Radios
- VSAT

Functional Diagram

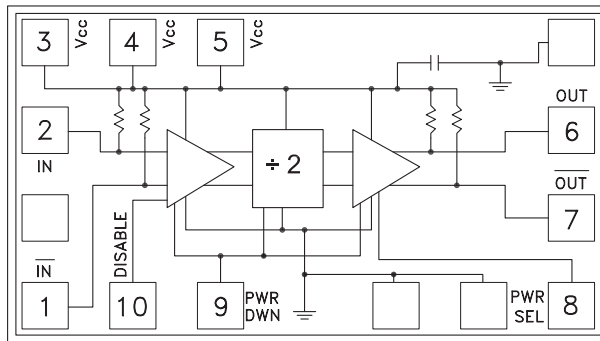

Features

- Ultra Low SSB Phase Noise: -148 dBc/Hz
- Wide Bandwidth
- Output Power: 3 dBm
- Single DC Supply: +5V
- Small Size: 1.14 x 0.69 x 0.1 mm

General Description

The HMC361 is a low noise Divide-by-2 Static Divider with InGaP GaAs HBT technology that has a small size of 1.14 x 0.69 mm. This device operates from DC (with a square wave input) to 11 GHz input frequency with a single +5V DC supply. The low additive SSB phase noise of -148 dBc/Hz at 100 kHz offset helps the user maintain good system noise performance.

Electrical Specifications, $T_A = +25^\circ \text{C}$, 50 Ohm System, $V_{cc} = 5V$

Parameter	Conditions	Min.	Typ.	Max.	Units
Maximum Input Frequency		11	12		GHz
Minimum Input Frequency	Sine Wave Input. [1]		0.2	0.5	GHz
Input Power Range	Fin = 1 to 9 GHz	-15	>-20	+10	dBm
	Fin = 9 to 11 GHz	-10	>-15	+2	dBm
Output Power [2]	Fin = 6 GHz	0	3		dBm
	Fin = 9 GHz	-5			dBm
	Fin = 11 GHz	-8			dBm
Reverse Leakage	Both RF Outputs Terminated		45		dB
SSB Phase Noise (100 kHz offset)	Pin = 0 dBm, Fin = 6 GHz		-148		dBc/Hz
Output Transition Time	Pin = 0 dBm, Fout = 882 MHz		100		ps
Supply Current (Icc) [2]			83		mA

[1] Divider will operate down to DC for square-wave input signal.

[2] When operated in high power mode (pin 8 connected to ground).

**GaAs HBT MMIC
DIVIDE-BY-2, DC - 11 GHz**

Input Sensitivity Window, $T = 25\text{ }^\circ\text{C}$

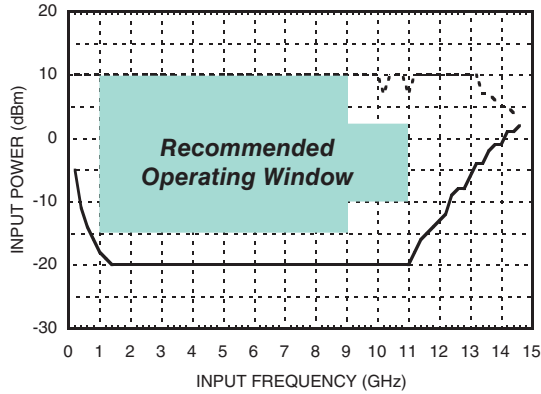

Input Sensitivity Window vs. Temperature

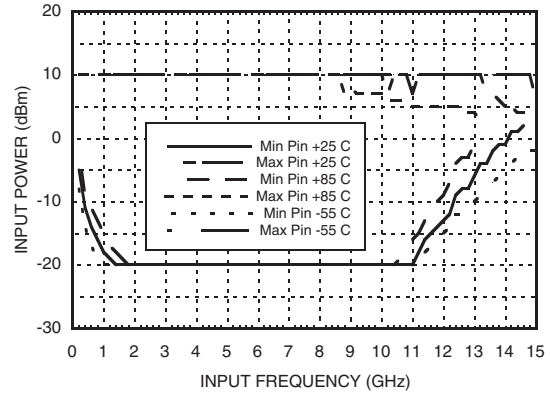

Output Power vs. Temperature

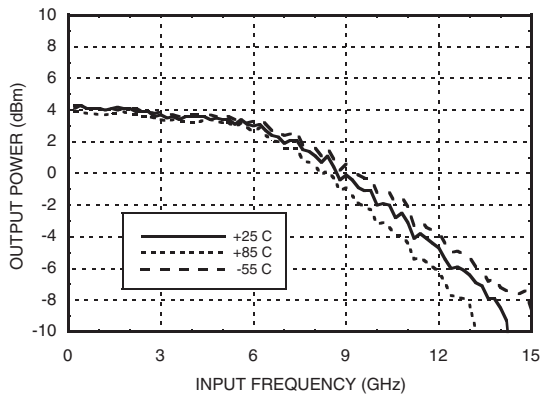

SSB Phase Noise Performance, $P_{in} = 0\text{ dBm}$, $T = 25\text{ }^\circ\text{C}$

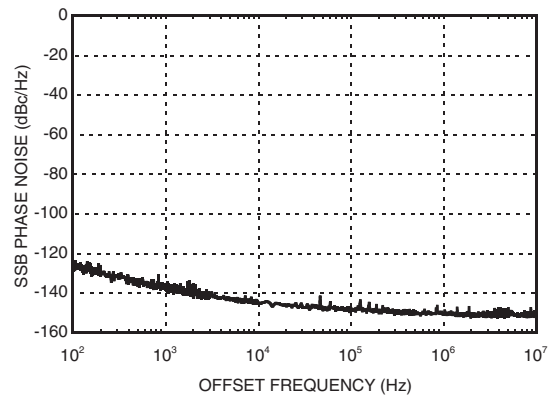

Output Harmonic Content, $P_{in} = 0\text{ dBm}$, $T = 25\text{ }^\circ\text{C}$

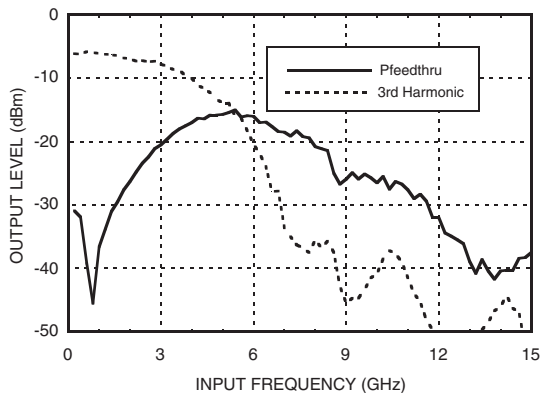

Reverse Leakage, $P_{in} = 0\text{ dBm}$, $T = 25\text{ }^\circ\text{C}$

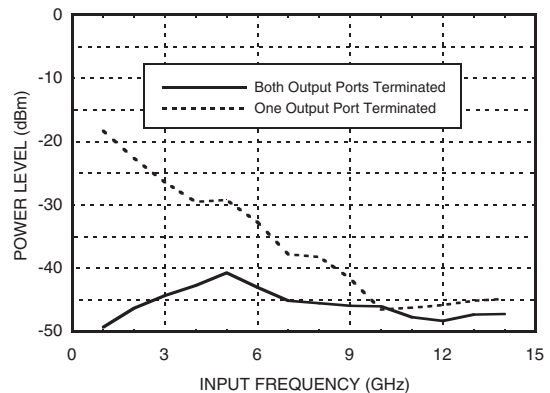

**GaAs HBT MMIC
DIVIDE-BY-2, DC - 11 GHz**

1

FREQUENCY DIVIDERS - CHIP

**Output Voltage Waveform,
Pin= 0 dBm, Fout= 882 MHz, T= 25 °C**

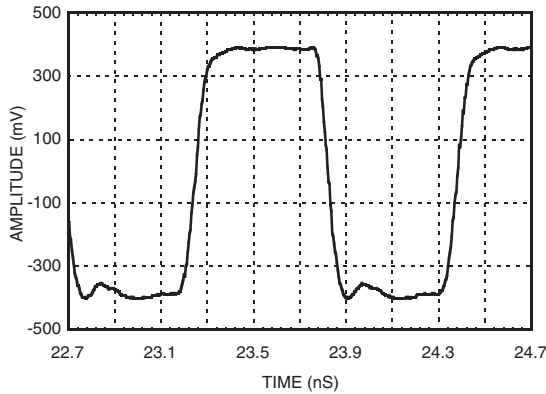

**ELECTROSTATIC SENSITIVE DEVICE
OBSERVE HANDLING PRECAUTIONS**

Absolute Maximum Ratings

RF Input (Vcc = +5V)	+13 dBm
Vcc	+5.5V
VLogic	Vcc -1.6V to Vcc -1.2V
Junction Temperature (Tj)	135 °C
Continuous P _{diss} (T= 85 °C) (derate 15.9 mW/ °C above 85 °C)	0.79W
Thermal Resistance (R _{TH}) (junction to die bottom)	63 °C/W
Storage Temperature	-65 to +150 °C
Operating Temperature	-55 to +85 °C

Typical Supply Current vs Vcc

Vcc (V)	I _{cc} (mA)
4.75	74
5.0	83
5.25	89

Note: Divider will operate over full voltage range shown above

Outline Drawing

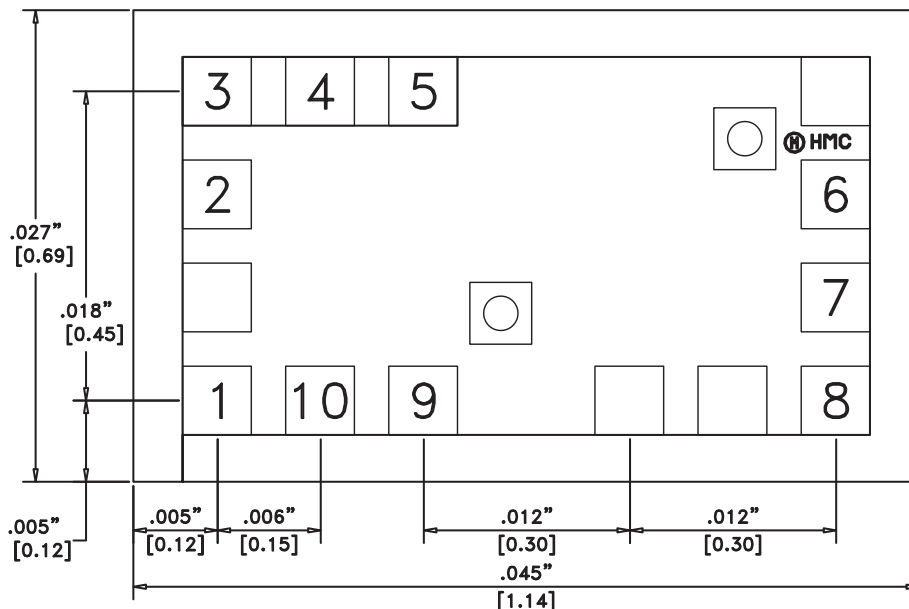

Die Packaging Information [1]

Standard	Alternate
WP-8 (Waffle Pack)	[2]

[1] Refer to the "Packaging Information" section for die packaging dimensions.

[2] For alternate packaging information contact Hittite Microwave Corporation.

NOTES:

- ALL DIMENSIONS IN INCHES (MILLIMETERS)
- ALL TOLERANCES ARE ± 0.001 (0.025)
- DIE THICKNESS IS 0.004 (0.100) BACKSIDE IS GROUND
- BOND PADS ARE 0.004 (0.100) SQUARE
- BOND PAD SPACING, CTR-CTR: 0.006 (0.150)
- BACKSIDE METALLIZATION: GOLD
- BOND PAD METALLIZATION: GOLD

For price, delivery, and to place orders, please contact Hittite Microwave Corporation:
20 Alpha Road, Chelmsford, MA 01824 Phone: 978-250-3343 Fax: 978-250-3373
Order On-line at www.hittite.com

**GaAs HBT MMIC
DIVIDE-BY-2, DC - 11 GHz**

Pad Description

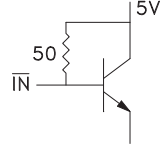
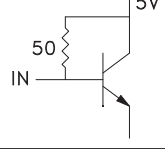
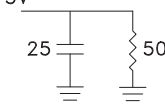
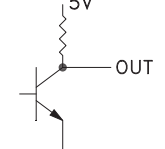
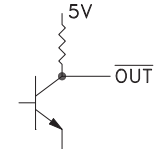
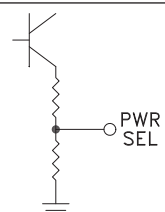
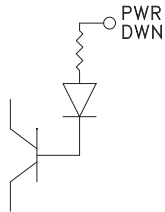
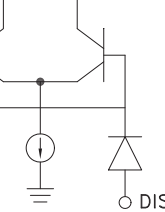
Pad Number	Function	Description	Interface Schematic
1	\overline{IN}	RF Input 180° out of phase with pad 3 for differential operation. AC ground for single ended operation.	
2	IN	RF Input must be DC blocked.	
3, 4, 5	Vcc	Supply Voltage 5V ±0.25V can be applied to pad 3, 4, or 5.	
6	OUT	Divided Output	
7	\overline{OUT}	Divided output 180° out of phase with OUT.	
8	PWR SEL	In the low power mode, the power select pin is left floating. By grounding this pin, the output power is increased by approximately 10 dB.	
9	PWR DWN	The power down pin is grounded for normal operation. Applying 5 volts to this pin will power down this device.	
10	DISABLE	The disable pin is grounded for normal operation. Applying 5 volts to this pin will disable the input buffer amplifier.	

Truth Table

Function	Pin	5V	GND	Float
DISABLE	10	Output Off	Output On	X
PWR DWN	9	Power Down	Power Up	X
PWR SEL	8	x	High Power Output	Low Power Output

X = State not permitted.

Assembly Diagram

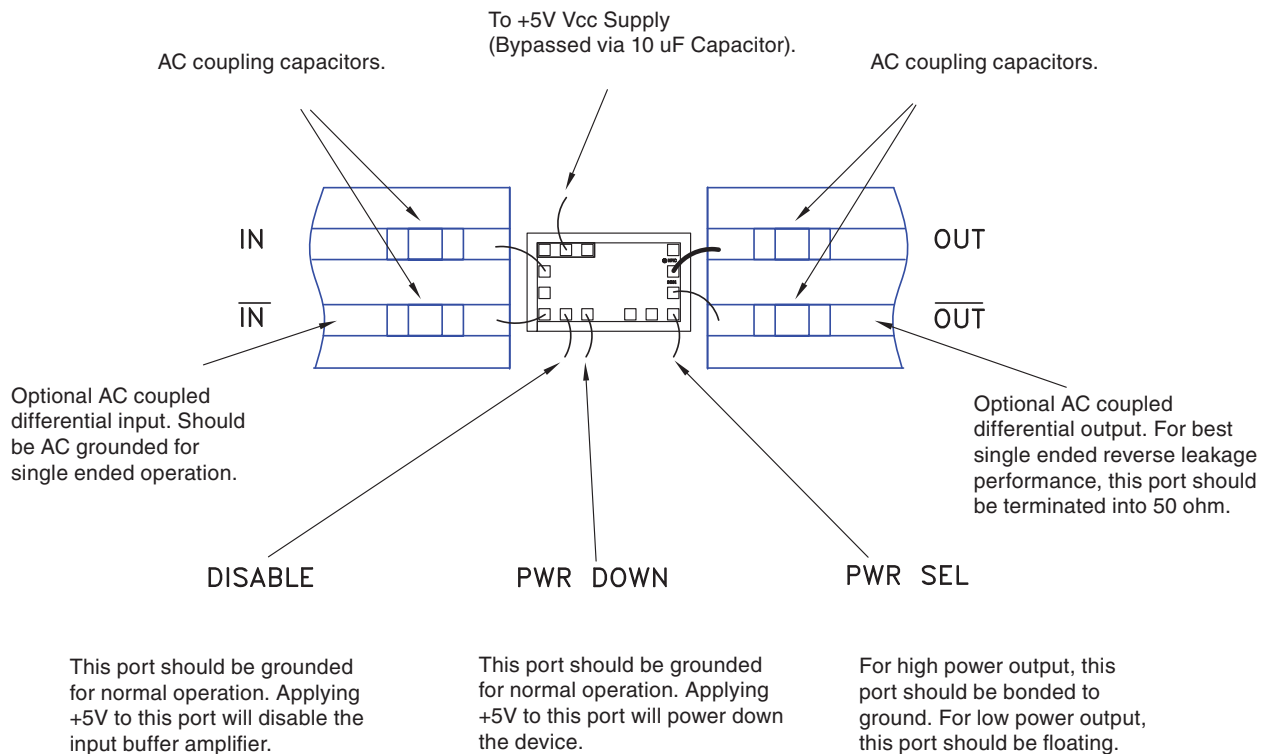

**GaAs HBT MMIC
DIVIDE-BY-2, DC - 11 GHz****Handling Precautions**

Follow these precautions to avoid permanent damage.

Cleanliness: Handle the chips in a clean environment. DO NOT attempt to clean the chip using liquid cleaning systems.

Static Sensitivity: Follow ESD precautions to protect against ESD strikes.

Transients: Suppress instrument and bias supply transients while bias is applied. Use shielded signal and bias cables to minimize inductive pick-up.

General Handling: Handle the chip along the edges with a vacuum collet or with a sharp pair of bent tweezers. The surface of the chip has fragile air bridges and should not be touched with vacuum collet, tweezers, or fingers.

Mounting

The chip is back-metallized and can be die mounted with electrically conductive epoxy. The mounting surface should be clean and flat.

Epoxy Die Attach: Apply a minimum amount of epoxy to the mounting surface so that a thin epoxy fillet is observed around the perimeter of the chip once it is placed into position. Cure epoxy per the manufacturer's schedule.

Wire Bonding

Ball or wedge bond with 0.025 mm (1 mil) diameter pure gold wire. Thermosonic wirebonding with a nominal stage temperature of 150 °C and a ball bonding force of 40 to 50 grams or wedge bonding force of 18 to 22 grams is recommended. Use the minimum level of ultrasonic energy to achieve reliable wirebonds. Wirebonds should be started on the chip and terminated on the package or substrate. All bonds should be as short as possible <0.31 mm (12 mils).