

DATA SHEET

SMP1322 Series: Low Resistance, Plastic Packaged PIN Diodes

Features

- Designed for high-performance wireless switch applications
- R_S @ 1 mA 0.8 Ω typical
- Available lead (Pb)-free and RoHS-compliant MSL-1 @ 260 °C per JEDEC J-STD-020
- Available in tape and reel packaging

Description

The SMP1322 series of plastic packaged, surface mountable PIN diodes are designed for high-volume switch applications from 10 MHz to beyond 2 GHz. The ultralow resistance of these diodes (1.5 Ω maximum at 1 mA and 0.5 Ω typical at 10 mA) makes the SMP1322 series suited to low-loss PIN diode switches in battery operated circuits. Available in a selection of plastic packages and in a variety of configurations including an ultralow inductance (0.2 nH) SOT-143 (SMP1322-017), the small footprint SC-79 and the miniature SC-70. In addition, the SMP1322-016 consists of two diodes in a SOT-143 package configured to enable insertion in a quarter-wave T/R switch with no crossover connections.

NEW

Skyworks offers lead (Pb)-free, RoHS (Restriction of Hazardous Substances)-compliant packaging.











Absolute Maximum Ratings

Characteristic	Value
Reverse voltage (V_R)	50 V
Power dissipation @ 25 °C lead temperature (P_D)	250 mW
Storage temperature (T_{ST})	-65 °C to +150 °C
Operating temperature (T_{OP})	-65 °C to +150 °C
ESD human body model	Class 1B

Performance is guaranteed only under the conditions listed in the specifications table and is not guaranteed under the full range(s) described by the Absolute Maximum specifications. Exceeding any of the absolute maximum/minimum specifications may result in permanent damage to the device and will void the warranty.

CAUTION: *Although this device is designed to be as robust as possible, ESD (Electrostatic Discharge) can damage this device. This device must be protected at all times from ESD. Static charges may easily produce potentials of several kilovolts on the human body or equipment, which can discharge without detection. Industry-standard ESD precautions must be employed at all times.*

							
Single	Common Anode	Common Cathode	Series Pair	Single	T/R Switch	Ultralow Inductance	Single
SOT-23	SOT-23	SOT-23	SOT-23	SOD-323	SOT-143	SOT-143	SC-79
SMP1322-001 Marking: PN1	SMP1322-003 Marking: PN9	SMP1322-004 Marking: PN3	SMP1322-005 Marking: PN2	SMP1322-011 Marking: PN	SMP1322-016 Marking: PN6	◆ SMP1322-017 Marking: PNF	SMP1322-079
SMP1322-001LF Marking: RN1	SMP1322-003LF Marking: RN9	SMP1322-004LF Marking: RN3	SMP1322-005LF Marking: RN2	SMP1322-011LF Marking: RN	SMP1322-016LF Marking: RN6	◆ SMP1322-017LF Marking: RNF	SMP1322-079LF
$L_S = 1.5 \text{ nH}$	$L_S = 1.5 \text{ nH}$	$L_S = 1.5 \text{ nH}$	$L_S = 1.5 \text{ nH}$	$L_S = 1.5 \text{ nH}$	$L_S = 1.5 \text{ nH}$	$L_S = 0.2 \text{ nH}$	$L_S = 0.7 \text{ nH}$
		SC-70					
		SMP1322-074 Marking: PN3					
		SMP1322-074LF Marking: RN3					
		$L_S = 1.4 \text{ nH}$					

 LF denotes lead (Pb)-free, RoHS-compliant packaging option as an alternative to our standard tin/lead (Sn/Pb) packaging.

 **Innovation to Go™**
Select Linear Products (indicated by ◆) now available for purchase online.

Electrical Specifications at 25 °C

Parameter	Condition	Typ.	Max.	Unit
Reverse current (I_R)	$V_R = 50 \text{ V}$		10	μA
Capacitance (C_T) ⁽¹⁾	$F = 1 \text{ MHz}, V = 30 \text{ V}$		1	pF
Resistance (R_S)	$F = 100 \text{ MHz}, I = 1 \text{ mA}$		1.5	Ω
Resistance (R_S)	$F = 100 \text{ MHz}, I = 10 \text{ mA}$	0.5		Ω
Forward voltage (V_F)	$I_F = 10 \text{ mA}$	0.85		V
Carrier lifetime (TI)	$I_F = 10 \text{ mA}$	0.4		μs
I region width		8		μm

1. The SMP1322-016, SMP1322-017 and SMP1322-017LF maximum capacitance is 1.15 pF.

Typical Performance Data

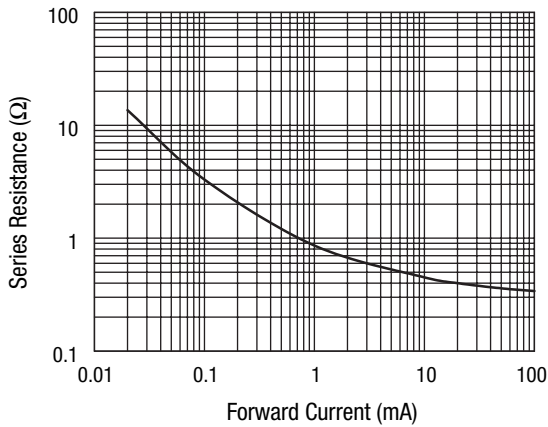

Series Resistance vs. Current @ 100 MHz

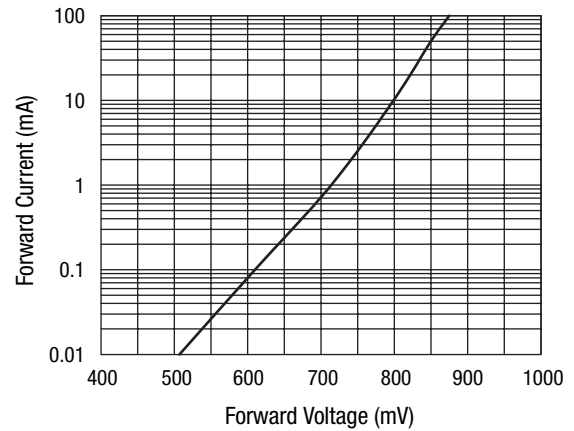

DC Characteristic

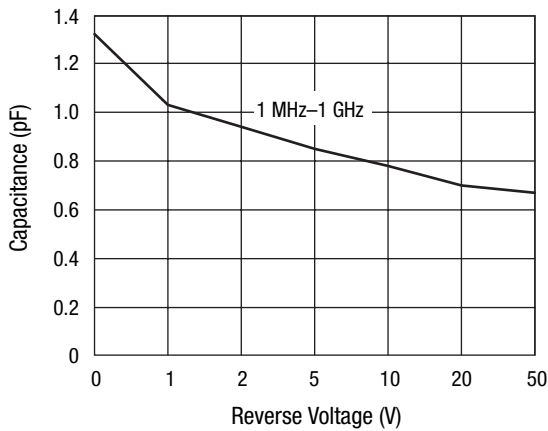

Capacitance vs. Reverse Voltage

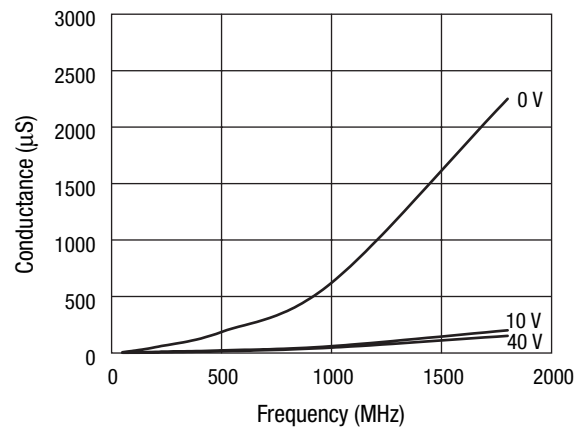

Conductance vs. Frequency and Reverse Voltage

Resistance vs. Temperature @ 500 MHz

I_F (mA)	R -55 °C (Ω)	R -15 °C (Ω)	R 25 °C (Ω)	R 65 °C (Ω)	R 100 °C (Ω)
0.02	9.5	9.4	9.9	10.5	10.9
0.1	3	3	3	3.3	3.5
0.3	1.5	1.5	1.5	1.6	1.8
0.5	1.1	1.1	1.2	1.2	1.4
1	0.922	0.914	0.902	0.963	1.1
10	0.568	0.559	0.533	0.563	0.655
20	0.532	0.52	0.494	0.521	0.61
100	0.483	0.469	0.44	0.464	0.565

SMP1322-016 SOT-143 T/R Switch

The SMP1322-016 is a low-cost PIN diode unconnected pair specifically designed for low-current drain antenna T/R switches in handheld wireless suits. In the specifically configured SOT-143 package, the PIN diodes are oriented to enable connection as a $\lambda/4$ switch with no external crossover connections.

SMP1322-016 in $\lambda/4$ T/R Switch

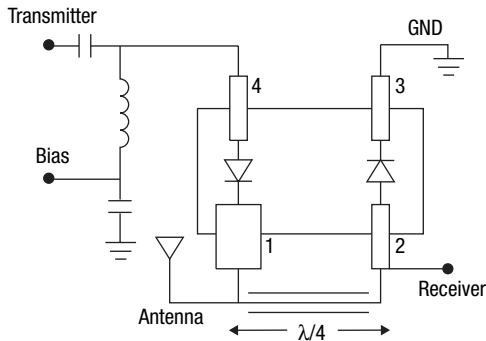

$\lambda/4$ T/R Switch

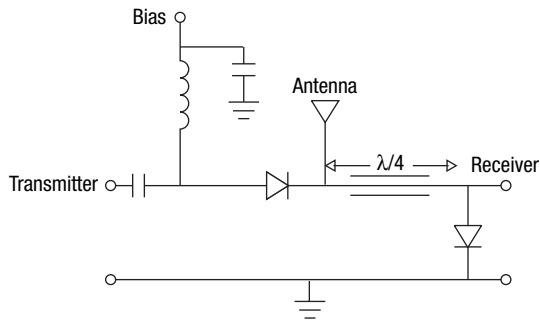

Recommended Solder Reflow Profiles

Refer to the [“Recommended Solder Reflow Profile”](#) Application Note.

Tape and Reel Information

Refer to the [“Discrete Devices and IC Switch/Attenuators Tape and Reel Package Orientation”](#) Application Note.

SMP1322-017 SOT-143 Low Inductance PIN Diode

The SMP1322-017 utilizes the SMP1322 PIN diode chip in a customized SOT-143 plastic package designed for high-isolation performance in a shunt connected switch. Its effective inductance, based on the 3 GHz isolation, is less than 0.2 nH. This diode is designed to work effectively as a shunt element in SPDT switches, covering the wireless frequencies from 900 MHz to beyond 2 GHz. Excellent performance is achievable when used in a quarter-wave T/R switch with the SMP1322-001 (SOT-23) or SMP1322-011 (SOD-323) PIN diode as the series connected diode.

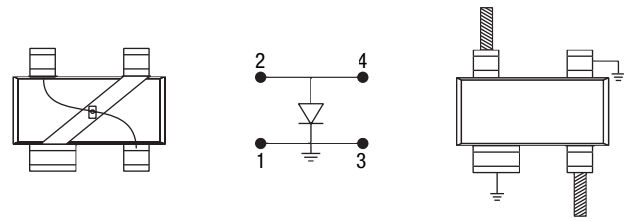

Lead Configuration

Schematic

Switch Connection

T/R Switch Design

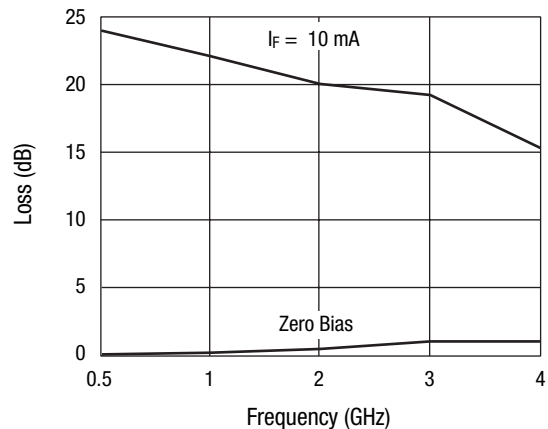
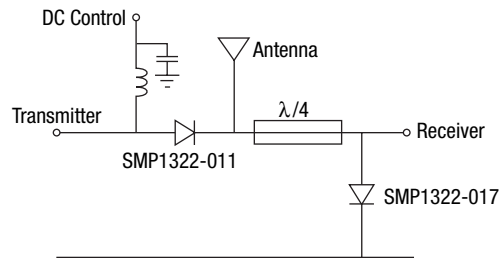

SMP1322-017 Typical SPDT Switch Performance

SOT-23

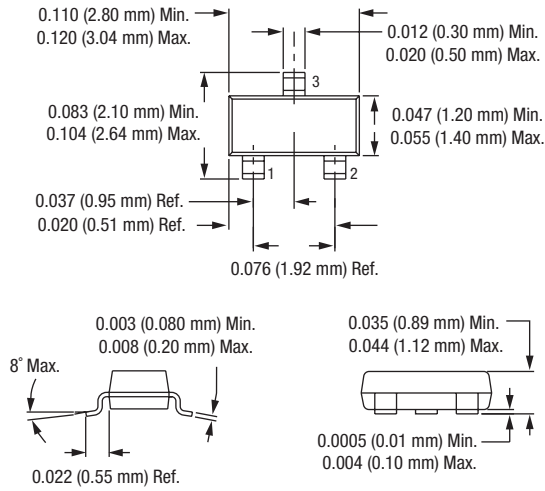

SOT-143

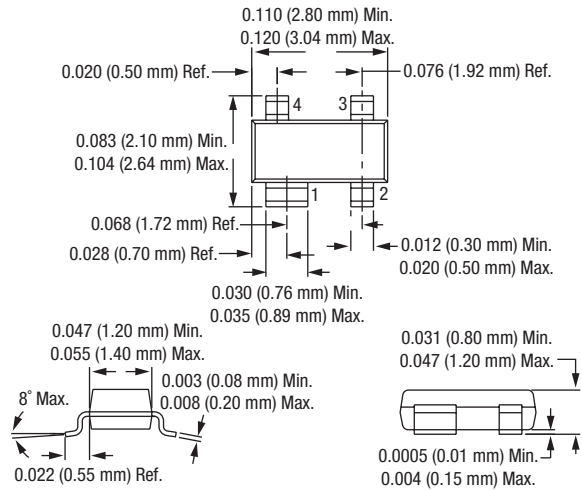

SOD-323

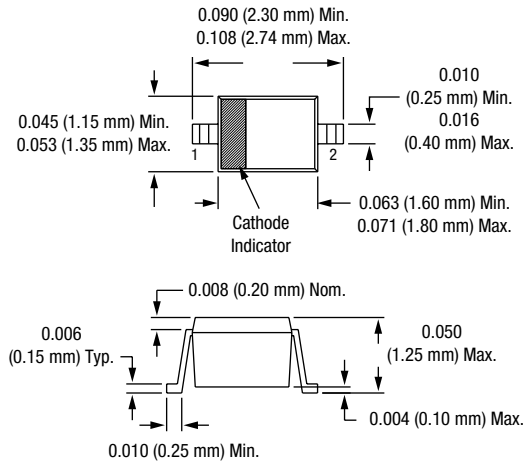

SC-70

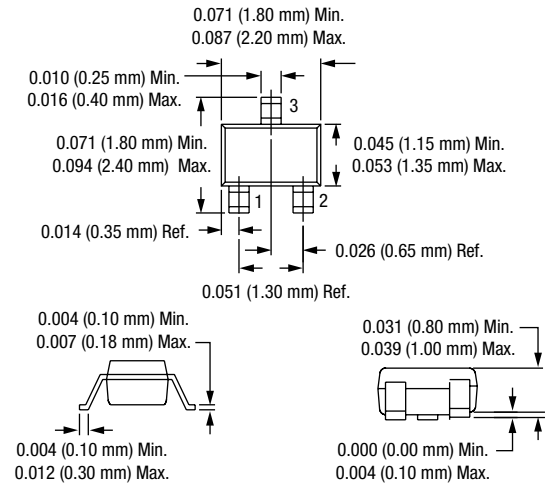

SC-79

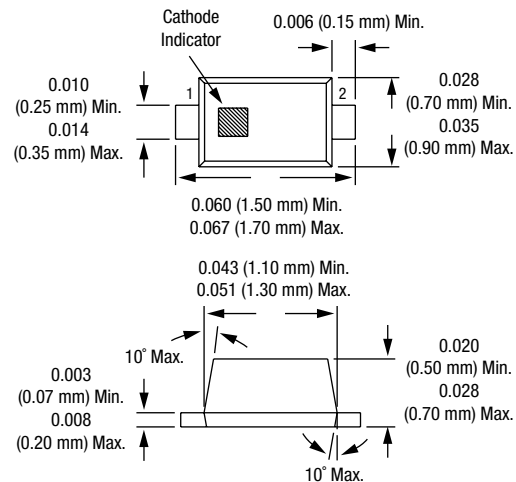

Copyright © 2002, 2003, 2004, 2005, Skyworks Solutions, Inc. All Rights Reserved.

Information in this document is provided in connection with Skyworks Solutions, Inc. ("Skyworks") products or services. These materials, including the information contained herein, are provided by Skyworks as a service to its customers and may be used for informational purposes only by the customer. Skyworks assumes no responsibility for errors or omissions in these materials or the information contained herein. Skyworks may change its documentation, products, services, specifications or product descriptions at any time, without notice. Skyworks makes no commitment to update the materials or information and shall have no responsibility whatsoever for conflicts, incompatibilities, or other difficulties arising from any future changes.

No license, whether express, implied, by estoppel or otherwise, is granted to any intellectual property rights by this document. Skyworks assumes no liability for any materials, products or information provided hereunder, including the sale, distribution, reproduction or use of Skyworks products, information or materials, except as may be provided in Skyworks Terms and Conditions of Sale.

THE MATERIALS, PRODUCTS AND INFORMATION ARE PROVIDED "AS IS" WITHOUT WARRANTY OF ANY KIND, WHETHER EXPRESS, IMPLIED, STATUTORY, OR OTHERWISE, INCLUDING FITNESS FOR A PARTICULAR PURPOSE OR USE, MERCHANTABILITY, PERFORMANCE, QUALITY OR NON-INFRINGEMENT OF ANY INTELLECTUAL PROPERTY RIGHT; ALL SUCH WARRANTIES ARE HEREBY EXPRESSLY DISCLAIMED. SKYWORKS DOES NOT WARRANT THE ACCURACY OR COMPLETENESS OF THE INFORMATION, TEXT, GRAPHICS OR OTHER ITEMS CONTAINED WITHIN THESE MATERIALS. SKYWORKS SHALL NOT BE LIABLE FOR ANY DAMAGES, INCLUDING BUT NOT LIMITED TO ANY SPECIAL, INDIRECT, INCIDENTAL, STATUTORY, OR CONSEQUENTIAL DAMAGES, INCLUDING WITHOUT LIMITATION, LOST REVENUES OR LOST PROFITS THAT MAY RESULT FROM THE USE OF THE MATERIALS OR INFORMATION, WHETHER OR NOT THE RECIPIENT OF MATERIALS HAS BEEN ADVISED OF THE POSSIBILITY OF SUCH DAMAGE.

Skyworks products are not intended for use in medical, lifesaving or life-sustaining applications, or other equipment in which the failure of the Skyworks products could lead to personal injury, death, physical or environmental damage. Skyworks customers using or selling Skyworks products for use in such applications do so at their own risk and agree to fully indemnify Skyworks for any damages resulting from such improper use or sale.

Customers are responsible for their products and applications using Skyworks products, which may deviate from published specifications as a result of design defects, errors, or operation of products outside of published parameters or design specifications. Customers should include design and operating safeguards to minimize these and other risks. Skyworks assumes no liability for applications assistance, customer product design, or damage to any equipment resulting from the use of Skyworks products outside of stated published specifications or parameters.

Skyworks, the Skyworks symbol, "Breakthrough Simplicity" and "Innovation to Go" are trademarks or registered trademarks of Skyworks Solutions, Inc., in the United States and other countries. Third-party brands and names are for identification purposes only, and are the property of their respective owners. Additional information, including relevant terms and conditions, posted at www.skyworksinc.com, are incorporated by reference.